

IEC Contactor Specifications

Bulletin Numbers 100/104-K, 100/104-C, 100/104S-C, 100/104-D, 100S-D, 100-G, 100Q-C

Topic	Page
Product Line Overview	3
100-K/104-K Miniature Contactors	5
Coil Voltage Codes	5
Assignment of Contacts	6
Specifications	8
Life-Load Curves	12
Approximate Dimensions	14
100-C/104-C, 100S-C/104S-C, 100Q-C Contactors	15
Coil Voltage Codes	15
Assignment of Contacts	18
Specifications	25
Life-Load Curves	36
Maximum Operating Rates	42
Approximate Dimensions	46
100-D/104-D, 100S-D Contactors	51
Coil Voltage Codes	51
Specifications	53
Life-Load Curves	63
Approximate Dimensions	65
100-G Contactors	67
Coil Voltage Codes	67
Specifications	67
Life-Load Curves	73
Permissible Switching Rate	75
Approximate Dimensions	77



Additional Resources





These documents contain additional information concerning related products from Rockwell Automation.

Resource	Description
Industrial Automation Wiring and Grounding Guidelines, publication 1770-4.1	Provides general guidelines for installing a Rockwell Automation industrial system.
Product Certifications website, http://www.ab.com	Provides declarations of conformity, certificates, and other certification details.



You can view or download publications at <http://www.rockwellautomation.com/literature/>. To order paper copies of technical documentation, contact your local Allen-Bradley distributor or Rockwell Automation sales representative.

Product Line Overview

IEC Contactors

					
Bulletin No.	100-K/104-K	100-C/104-C	100Q-C	100-D/104-D	100-G
Screw Terminals	✓	✓	✓	Thru-hole, threaded (630...860 A)	Thru-hole
Spring Terminals	✓ (5...9 A)	✓ (9...16 A)	—	—	—
Max. Current I_e	12 A	97 A	37 A	860 A	1200 A
Current Rating	5...12 A	9...97 A	16, 32 A	115...860 A	550...1200 A
Features	<ul style="list-style-type: none"> • Mini-contactors • Uniform panel mounting dimensions • Panel mounting or mounting on 35 mm DIN Rail • AC or DC coil control • Made of environmentally friendly materials 	<ul style="list-style-type: none"> • Panel mounting or mounting on 35 mm DIN Rail • AC or DC coil control • Reversible coil terminals (line or load side) • Common accessories • Made of environmentally friendly materials 	<ul style="list-style-type: none"> • Panel mounting or mounting on 35 mm DIN Rail • AC or DC coil control • Reversible coil terminals (line or load side) • Common accessories • Made of environmentally friendly materials 	<ul style="list-style-type: none"> • Panel mounting only • Made of environmentally friendly materials • AC or DC coil control (conventional or electronic) • Integrated PLC interface (electronic coil) 	<ul style="list-style-type: none"> • Panel mounting • AC or DC coil control • Horizontal or vertical interlock • Latching • 4th pole
Contacts	3 power poles with internal N.O. or N.C. auxiliary contact, or 4 power poles. Optional front-mounted 2- or 4-pole external auxiliary contact block.	3 power poles with internal N.O. or N.C. auxiliary contact or 4 power poles. Optional front- or side-mounted 1-, 2- or 4-pole external auxiliary contact block.	3 main poles with front-mount resistor elements. Optional side-mounted 1-, 2- or 4-pole external auxiliary contact block.	3 power poles with external N.O. and N.C. side-mounted auxiliary contact. Optional side-mounted 2-pole external auxiliary contact blocks	3 power poles with N.O. and N.C. front-mounted auxiliary contact. Optional 4th pole and auxiliary contacts
Coil Voltages	AC = 24...600V, 50/60Hz DC = 12...250V	AC = 12...600V, 50/60Hz DC = 9...250V	AC = 12...600V, 50/60Hz DC = 12...250V	Conventional Coils Cat. Nos. 100-D115...D180 AC: 24...550V 50 Hz, 24...600V 60Hz, 100...277V 50/60Hz DC: 24...250V DC Electronic Coils Cat. Nos. 100-D115...D300 AC: 24...500V 50/60 Hz DC: 24...255V DC Cat. Nos. 100-D420 AC: 42...500V 50/60 Hz DC: 48...255V DC Cat. Nos. 100-D630...D860 AC: 100...600V 50/60 Hz DC: 110...255V DC	AC = 110...480V, 50/60Hz DC = 100...440V
Optional Overload Relays	Electronic or bimetallic	Electronic or bimetallic	—	Electronic	Electronic
Optional Accessories	<ul style="list-style-type: none"> • Front-mount auxiliary contacts • Surge suppressors • Electronic timers • Mechanical interlocks 	<ul style="list-style-type: none"> • Front or side-mount auxiliary contacts • Surge suppressors • Electronic or pneumatic timers • Mechanical interlocks • Mechanical latches 	<ul style="list-style-type: none"> • Side-mount auxiliary contacts • Surge suppressors • Electronic timers 	<ul style="list-style-type: none"> • Side-mount auxiliary contacts • Surge suppressors • IP20 terminal blocks • Terminal shields • Terminal covers • Connecting components • Terminal lugs • Mechanical/electrical interlocks 	<ul style="list-style-type: none"> • Auxiliary contact • 4th pole • Vertical interlock • Horizontal interlock • Mechanical latch
Standards/Certifications	<ul style="list-style-type: none"> • UL • CSA • IEC • CE Marked • CCC 	<ul style="list-style-type: none"> • UL • CSA • IEC • CE Marked • CCC 	<ul style="list-style-type: none"> • UL • CSA • IEC • CE Marked 	<ul style="list-style-type: none"> • UL • CSA • IEC • CE Marked • CCC (115...180 A - conventional coil; 140...420 A - electronic coil) 	<ul style="list-style-type: none"> • UL • CSA • IEC • CE Marked

Safety Contactors

		
Bulletin No.	1005-C/1045-C	1005-D
Screw Terminals	✓	Thru-hole, threaded (630...860 A)
Max. Current I_e	97 A	860 A
Current Rating	9...97 A	115...860 A
Features	<ul style="list-style-type: none"> Positively guided/mechanically linked auxiliary contacts Front-mounted auxiliary contacts: <ul style="list-style-type: none"> Permanently fixed Protective cover to prevent manual operation Red contact housing for easy identification Incorporates IEC 947-5-1 "Mechanically Linked" symbol Optional gold-plated bifurcated versions AC and DC operating coils SUVA third-party certification 	<ul style="list-style-type: none"> Mirror contact performance on auxiliary contacts, which are required in feedback circuit for modern safety applications. The N.C. auxiliary contacts will not change state when a power contact welds. SUVA third-party certification AC and DC operating coils "Mirror Contact" symbol
Contacts	3 main poles with N.C. mechanically linked feedback contacts	3 main poles with N.C. mechanically linked feedback contacts
Coil Voltages	AC = 12...600V, 50/60Hz DC = 12...250V	<p style="text-align: center;">Conventional Coils Cat. Nos. 1005-D115...D180 AC: 24...550V, 50 Hz; 24...600V, 60Hz; 100...277V, 50/60Hz DC: 24...250V</p> <p style="text-align: center;">Electronic Coils Cat. Nos. 1005-D115...D300 AC: 24...500V, 50/60 Hz DC: 24...255V</p> <p style="text-align: center;">Cat. Nos. 1005-D420 AC: 42...500V 50/60 Hz DC: 48...255V</p> <p style="text-align: center;">Cat. Nos. 1005-D630...D860 AC: 100...600V, 50/60 Hz DC: 110...255V</p>
Optional Accessories	<ul style="list-style-type: none"> Side-mount auxiliary contacts Surge suppressors Electronic timers Mechanical interlocks 	<ul style="list-style-type: none"> Side-mount auxiliary contacts Surge suppressors IP20 terminal blocks Terminal shields Terminal covers Connecting components Terminal lugs Mechanical/electrical interlocks
Standards Compliance	<ul style="list-style-type: none"> EN/IEC 60947-4 IEC 60947-5-1 Annex L — Mechanically Linked Contacts IEC 60947-4-1 Annex H — Mirror Contacts UL 508 CSA C22.2 No. 14 EN50205 	<ul style="list-style-type: none"> EN/IEC 60947-4 IEC 60947-4-1, Annex H — Mirror Contacts IEC 60947-4-1/A1: 2002-09, Annex F UL 508 CSA C22.2, No. 14
Certifications	<ul style="list-style-type: none"> cULus Listed (File No. E3125; Guide NLDX, NLDX7) SUVA Third-Party Certified CE Marked 	<ul style="list-style-type: none"> cULus Listed (File No. E3125; Guide No. NLDX, NLDX7) SUVA Third-Party Certified CE Marked CCC (115...180 A - conventional coil; 140...420 A - electronic coil)

100-K/104-K Miniature Contactors

Coil Voltage Codes

⊗ Coil Voltage Code for screw type terminal versions

The Cat. No. as listed is incomplete. Select a coil voltage code from the table below to complete the Cat. No. Example: 120V, 60 Hz: Cat. No. 100-K09⊗10 becomes Cat. No.100-K09D10.

AC Voltages [V]	24	110	120	230	240	400	480	600
50 Hz	—	D	—	—	—	—	—	—
60 Hz	—	—	D	—	—	—	B	VC
50/60 Hz	KJ	—	—	KF	KA	KN	—	—

DC Voltages [V]	12	24	110	125	220	250
Standard	ZQ	ZJ	ZD	ZS	ZA	ZT
with Integrated Diode	—	DJ	—	—	—	—

⊗ Coil Voltage Code for spring clamp type terminal versions

The Cat. No. as listed is incomplete. Select a coil voltage code from the table below to complete the Cat. No. Example: 120V, 60 Hz: Cat. No. 100-KR09⊗10 becomes Cat. No.100-KR09D10.

AC Voltages [V]	24	110	120	230
50 Hz	—	D	—	—
60 Hz	—	—	D	—
50/60 Hz	KJ	—	—	KF

DC Voltages [V]	24	110
Standard	ZJ	ZD
with Integrated Diode	DJ	—

Assignment of Contacts

Device Combinations in Accordance with IEC 60947-1 / -4-1

Table valid for : AC / DC = 0.85...1.1 x U_S, T_{amb} = -25 °C...+60 °C, normal position (horizontal rail mounting)

Auxiliary Contact Blocks ⁽¹⁾		100-K Miniature Contactors (AC and DC Control)					
Circuit Diagram	Control	100-K05⊗10 100-K09⊗10 100-K12⊗10	100-K05⊗01 100-K09⊗01 100-K12⊗01	100-K05⊗400 100-K09⊗400 100-K12⊗400	100-K05⊗300 100-K09⊗300 100-K12⊗300	100-K05⊗200 100-K09⊗200 100-K12⊗200	
Front Mounting							
100-KFA02E		AC/DC	(2)	01 + 02 = 03 ⁽³⁾	(2)	(2)(3)	—
100-KFC02		AC/DC	10 + 02 = 12	—	00 + 02 = 02	00 + 02 = 02 ⁽³⁾	—
100-KFA11E		AC/DC	(2)	01 + 11 = 12	(2)	(2)	(2)
100-KFB11		AC/DC	10 + 11 = 21	—	00 + 11 = 11	00 + 11 = 11	00 + 11 = 11
100-KFC11		AC/DC	10 + 11 = 21	(2)	00 + 11 = 11	00 + 11 = 11	00 + 11 = 11
100-KFA20E		AC/DC	(2)	01 + 20 = 21	(2)	(2)	(2)
100-KFC20		AC/DC	10 + 20 = 30	(2)	00 + 20 = 20	00 + 20 = 20	00 + 20 = 20
100-KFA04E		AC/DC	(2)(3)	—	(2)(3)	—	—
100-KFC04		AC/DC	10 + 04 = 14 ⁽³⁾	—	00 + 04 = 04 ⁽³⁾	—	—
100-KFA13E		AC/DC	(2)	01 + 13 = 14 ⁽³⁾	(2)	(2)(3)	—
100-KFC13		AC/DC	10 + 13 = 23	(2)(3)	00 + 13 = 13	00 + 13 = 13 ⁽³⁾	—
100-KFA22Z		AC/DC	(2)	01 + 22 = 23 ⁽³⁾	(2)	(2)(3)	—
100-KFB22		AC/DC	10 + 22 = 32	—	00 + 22 = 22	00 + 22 = 22 ⁽³⁾	—
100-KFC22		AC/DC	10 + 22 = 32	(2)(3)	00 + 22 = 22	00 + 22 = 22 ⁽³⁾	—

Auxiliary Contact Blocks ⁽¹⁾		100-K Miniature Contactors (AC and DC Control)					
Circuit Diagram	Control	100-K05⊗10	100-K05⊗01	100-K05⊗400	100-K05⊗300	100-K05⊗200	
		100-K09⊗10	100-K09⊗01	100-K09⊗400	100-K09⊗300	100-K09⊗200	
		100-K12⊗10	100-K12⊗01	100-K12⊗400	100-K12⊗300	100-K12⊗200	
100-KFA31Z		AC/DC	(2)	—	(2)(4)	—	—
100-KFC31		AC/DC	10 + 31 = 41 ⁽⁴⁾	—	00 + 31 = 31 ⁽⁴⁾	—	—
100-KFA40E		AC/DC	(2)	—	(2)	(2)	(2)
100-KFC40		AC/DC	10 + 40 = 50	(2)	00 + 40 = 40	00 + 40 = 40	00 + 40 = 40

(1) For other operating limits, please contact your local Rockwell Automation sales office or Allen-Bradley distributor

(2) Combination possible but not recommended, due to repeating or not consecutive sequence numbering

(3) T_{amb} max. +40 °C

(4) T_{amb} max. +40 °C and only allowed for coil voltage 24V DC or 230V AC



Specifications

		100-KR		100/104-K				
		05	09	05	09	12		
Coil Type:	Conventional	X	X	X	X	X		
AC-1 Active Power Load (50 Hz); Ambient temperature 40 °C								
Rated Operational Current, I_e	≤500V [A]	10	10	20	20	20		
	690V [A]	10	10	20	20	20		
	230V [kW]	4	4	8	8	8		
	240V [kW]	4	4	8.3	8.3	8.3		
	400V [kW]	6.9	6.9	14	14	14		
	415V [kW]	7	7	14	14	14		
	500V [kW]	8.7	8.7	17	17	17		
	690V [kW]	12	12	24	24	24		
	AC-1 Active Power Load (50 Hz); Ambient temperature 60 °C							
Rated Operational Current, I_e	≤500V [A]	10	10	16	16	16		
	690V [A]	10	10	16	16	16		
	230V [kW]	4	4	6.4	6.4	6.4		
	240V [kW]	4	4	6.7	6.7	6.7		
	400V [kW]	6.9	6.9	11	11	11		
	415V [kW]	7	7	12	12	12		
	500V [kW]	8.7	8.7	14	14	14		
	690V [kW]	12	12	19	19	19		
	Switching of 3-phase Motors; (50 Hz) Ambient temperature 60 °C, AC-2, AC-3							
Rated Operational Current, I_e	230V [A]	6.3	8.5	6.3	11.3	11.3		
	240V [A]	6.3	8.5	6.3	11.3	11.3		
	400V [A]	4.9	8.5	4.9	8.5	11.5		
	415V [A]	4.9	8.5	4.9	8.5	11.5		
	500V [A]	3.9	6.8	3.9	6.8	9.2		
	690V [A]	2.8	4.9	2.8	4.9	6.7		
	230V [kW]	1.5	2.2	1.5	3	3		
	240V [kW]	1.5	2.2	1.5	3	3		
	400V [kW]	2.2	4	2.2	4	5.5		
	415V [kW]	2.2	4	2.2	4	5.5		
	500V [kW]	2.2	4	2.2	4	5.5		
	690V [kW]	2.2	4	2.2	4	5.5		
	Load Carrying Capacity per UL/CSA							
	General Purpose Current (enclosed)		[A]	9	9	12	15	18
	Rated power (enclosed) 1-phase	115V [A]	7.2	7.2	9.8	9.8	13.8	
230V [A]		6.9	8	8	10	12		
115V [Hp]		1/3	1/3	0.5	0.5	0.75		
230V [Hp]		3/4	1	1	1.5	2		
200V [A]		6.9	7.8	6.9	7.8	11		
Rated power (enclosed) 3-phase	230V [A]	6	6.8	6	6.8	9.6		
	460V [A]	4.8	7.6	4.8	7.6	11		
	575V [A]	3.9	6.1	3.9	6.1	9		
	200V [Hp]	1.5	2	1.5	2	3		
	230V [Hp]	1.5	2	1.5	2	3		
	460V [Hp]	3	5	3	5	7.5		
	575V [Hp]	3	5	3	5	7.5		

		100/104-K			
		05	09	12	
Coil Type:	Conventional	X	X	X	
Switching of 3-phase Motors, (50 Hz); Ambient temperature 60 °C, AC-4					
	230V [A]	6.3	11.3	11.3	
	240V [A]	6.3	11.3	11.3	
	400V [A]	4.9	8.5	11.5	
	415V [A]	4.9	8.5	11.5	
	500V [A]	3.9	6.8	9.2	
	690V [A]	2.8	4.9	6.7	
	230V [Hp]	1.5	3	3	
	240V [Hp]	1.5	3	3	
	400V [Hp]	2.2	4	5.5	
	415V [Hp]	2.2	4	5.5	
	500V [Hp]	2.2	4	5.5	
	690V [Hp]	2.2	4	5.5	
	AC-4 at approximately 200,000 operations				
		230V [A]	2.3	3.9	3.9
		240V [A]	2.3	3.9	3.9
400/415V [A]		2	3.6	3.6	
500V [A]		1.9	3.2	3.2	
230V ⁽¹⁾ [Hp]		0.37	0.75	0.75	
240V ⁽¹⁾ [Hp]		0.37	0.75	0.75	
400V ⁽¹⁾ [Hp]		0.75	1.5	1.5	
415V ⁽¹⁾ [Hp]		0.75	1.5	1.5	
500V ⁽¹⁾ [Hp]		0.75	1.5	1.5	
Max. switching frequency		Ops/hour	250	250	250
Wye-Delta (60 Hz)					
	200V [Hp]	2.2	3	5	
	230V [Hp]	2.2	3	5	
	460V [Hp]	5	7.5	10	
	575V [Hp]	5	7.5	10	
Star-Delta Starting (50 Hz)					
	≤ 230V [A]	11.3	20	20	
	≤ 240V [A]	11.3	20	20	
	400V [A]	8.5	15.5	15.5	
	415V [A]	8.5	15.5	15.5	
	500V [A]	6.8	12.4	12.4	
	690V [A]	4.9	8.9	8.9	
	230V ⁽¹⁾ [kW]	3	5.5	5.5	
	240V ⁽¹⁾ [kW]	3	5.5	5.5	
	400V ⁽¹⁾ [kW]	3	5.5	5.5	
	415V ⁽¹⁾ [kW]	4	7.5	10	
	500V ⁽¹⁾ [kW]	4	7.5	11	
	690V ⁽¹⁾ [kW]	4	7.5	7.5	

(1) Power ratings at 50 Hz; Preferred values according to IEC 60072-1

		100/104-K			
		05	09	12	
Coil Type:	Conventional	X	X	X	
Switching of Power Transformers, AC-6a (50 Hz)					
Inrush Current	=n				
Rated transformer current					
n=30	≤ 230V	[A]	2.9	5.4	5.4
	≤ 240V	[A]	2.9	5.4	5.4
	≤ 400V	[A]	2.4	4.1	5.4
	≤ 415V	[A]	2.4	4.1	5.4
	≤ 500V	[A]	1.8	3.2	3.2
	230V	[kVA]	1.2	2	2
	240V	[kVA]	1.2	2	2
	400V	[kVA]	1.7	2.8	3.4
	415V	[kVA]	1.7	2.8	3.4
	500V	[kVA]	1.7	2.8	3.4
690V	[kVA]	2	4	5	
Switching of Lamps					
Gas discharge lamps AC-5a, 40 °C					
open	[A]	18	18	18	
enclosed	[A]	14.5	14.5	14.5	
Individually compensated:					
Max. capacitance at expected					
Short-circuit current of	10 kA	[μF]	750	750	750
	20 kA	[μF]	400	400	400
Filament AC-5b	230/240V	[A]	5	9	9
Switching of Low Inductive Loads in Home Appliances and Similar Applications per IEC 61095 (50 Hz)					
AC-7a	230V	[A]	20	20	20
	400V	[A]	20	20	20
Switching of Motor Load for Home Appliances (50 Hz)					
AC-7b	230V	[A]	6	11	11
	400V	[A]	6	11	11
Switching of Hermetically Sealed Cooling Compressor Motors - manual reset of overload release (50 Hz)					
AC-8a	400V	[A]	11	18	18
	500V	[A]	10	15	15
Switching of DC Loads					
Non-inductive or slightly inductive loads or resistance furnaces DC-1, 60 °C					
1 pole	24V	[A]	6	9	9
	48/60V	[A]	4/1	6/1.5	6/1.5
	110V	[A]	0.6	1	1
	220V	[A]	0.2	0.3	0.3
	440V	[A]	0.08	0.1	0.1
2 poles in series	24V	[A]	6	9	9
	48/60V	[A]	6	8	8
	110V	[A]	4	6	6
	220V	[A]	0.8	1.2	1.2
	440V	[A]	0.2	0.3	0.3

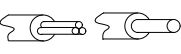
		100/104-K				
		05	09	12		
Coil Type:	Conventional	X	X	X		
3 poles in series	24V	[A]	6	9	9	
	48/60V	[A]	6	9	9	
	110V	[A]	6	9	9	
	220V	[A]	3	4	4	
	440V	[A]	0.4	0.6	0.6	
Shunt-wound Motors						
Starting, reverse current braking, reversing, stepping DC-3, 60 °C						
3 poles in series	24V	[A]	5	9	9	
	48/60V	[A]	4	6	6	
	110V	[A]	2	3	3	
	220V	[A]	0.8	1.2	1.2	
	440V	[A]	0.15	0.2	0.2	
Series-wound Motors						
Starting, reverse current braking, reversing, stepping DC-5, 60 °C						
3 poles in series	24V	[A]	5	9	9	
	48/60V	[A]	2	3	3	
	110V	[A]	0.6	1	1	
	220V	[A]	0.1	0.1	0.1	
Short Time Withstand I_{CW} 60 °C	10 s	[A]	60	96	96	
Resistance and Power Dissipation						
Main current circuit resistance	[mΩ]	2.2	2.2	2.2		
Power dissipation by all circuits at I_e AC-3/400V	[W]	0.3	0.9	0.9		
Total power dissipation						
At I_e AC-3/400V	AC control	[W]	2.1	2.7	2.7	
	DC control (electronic)	[W]	2.9	3.5	3.5	
Lifespan						
Mechanical AC control	[Mil. operations]	15	15	15		
Mechanical DC control	[Mil. operations]	15	15	15		
Electrical AC-3 (400 V)	[Mil. operations]	0.7	0.7	0.7		
Weight						
AC	Non-Rev.	kg (lbs.)	0.16 (0.35)			
	Rev.	kg (lbs.)	0.4 (0.88)			
DC	Non-Rev.	kg (lbs.)	0.2 (0.44)			
	Rev.	kg (lbs.)	0.48 (1.06)			
		100-KR		100/104-K		
		05	09	05	09	12
Coil Type:	Conventional	X	X	X	X	X
Conductor Cross Sections - Main Contacts Terminal type						(2)
	1 conductor	[mm ²]	0.50...2.5			0.75...2.5
	2 conductors	[mm ²]	0.50...2.5			0.75...2.5
	1 conductor	[mm ²]	0.75...2.5 ⁽¹⁾			1...4
	2 conductors	[mm ²]	0.75...2.5 ⁽¹⁾			1...2.5+1...4
Recommended torque	[N·m]	—			1.2	
Cross section per UL/CSA	[AWG]	18...14 ⁽¹⁾			18...12	
Recommended torque	[lb-in]	—			10.6	

(1) Fine- or coarse-stranded only

(2) Pozidriv No. 2 / Blade No. 3 screw

Short-Circuit Coordination Data

See www.ab.com/certifications/ul508a for complete short-circuit current ratings.



		100/104-K		
		05	09	12
Coil Type:	Conventional	X	X	X
Short Circuit Coordination (Max. Fuse or Circuit Breaker Rating) Per IEC 60947-4-1 (contactor and fuses only)				
DIN Fuses- gG, gL		50 kA Available Fault Current		
Type "1" (690V)	[A]	35	35	35
Type "2" (400V)	[A]	16	20	20
Per UL 508 and CSA 22.2 No. 14 (contactor and fuses or circuit breaker only)				
UL Class K5 and RK5 Fuses		5 kA Available Fault Current		
UL Listed Combination (600V)	[A]	40	40	40
UL Class CC and CSA HRCI-MISC Fuses				
UL Listed Combination (600V)	[A]	30	30	30
UL Class J and CSA HRCI-J Fuses		50 kA Available Fault Current		
UL Listed Combination (600V)	[A]	30	30	30

Coil Data

		100/104-K		
		05	09	12
Coil Type:	Conventional	X	X	X
Operating Limits				
50 Hz, 60 Hz, 50/60 Hz	pick-up	[x U _s]	0.85...1.1	
	dropout	[x U _s]	0.2...0.75	
DC (conventional)	pick-up	[x U _s]	0.8...1.1 0.7...1.25 ⁽¹⁾	
	dropout	[x U _s]	0.1...0.75	
Coil Consumption				
50 Hz, 60 Hz, 50/60 Hz	pick-up	[VA]	35	
	hold-in	[VA/W]	5/1.8	
DC (conventional)	pick-up	[W]	cold 3.0, warm 2.6	
	hold-in	[W]	cold 3.0, warm 2.6	
Operating Times				
AC	closing delay	[ms]	15...40	
	opening delay	[ms]	15...33	
With RC module	closing delay	[ms]	15...28	
DC (conventional)	opening delay	[ms]	18...40	
	closing delay	[ms]	6...12	
With integrated diode	opening delay	[ms]	8...12	
With external diode	opening delay	[ms]	35...50	

(1) For 9, 12, 24, and 110V DC coils

Auxiliary Contacts, Auxiliary Contact Blocks, and Pneumatic Timers

		Internal	Front mounted
Switching of AC Loads			
AC-12 I _{th}	at 40 °C	[A]	10
	at 60 °C	[A]	6
AC-15 at rated voltage of	24V	[A]	6
	42/48V	[A]	6
	120V	[A]	6
	230V	[A]	3
	240V	[A]	3
	400V	[A]	1.8
	415V	[A]	1.8
DC-12 L/R < 1 ms resistive loads at	24V DC	[A]	6
	48V DC	[A]	4
	110V DC	[A]	0.6
	220V DC	[A]	0.2
DC-14L/R < 15 ms inductive loads with economy resistor in series at	440V DC	[A]	0.08
	24V DC	[A]	4
	48V DC	[A]	2.5
	110V DC	[A]	0.4
DC-13 switching electromagnets at	220V DC	[A]	0.12
	440V DC	[A]	0.05
	24V DC	[A]	2.8
	48V DC	[A]	1.2
Fuse gG	110V DC	[A]	0.55
	220V DC	[A]	0.27
	440V DC	[A]	0.15
		[A]	10
	[A]	10	
Min. switching capacity according to IEC 60947-5-4			15V/ 10 mA
Load Carrying Capacity per UL/CSA			
Rated voltage	AC	[V]	max.600
Continuous rating	40 °C	[A]	10
Switching capacity	AC	[A]	A600
		[A]	B600
Rated voltage	DC	[V]	max.600
Switching capacity	DC	[A]	Q600

General

Rated Isolation Voltage U_i		
IEC	[V]	690
UL, CSA	[V]	600
Rated Impulse Voltage Withstand U_{imp}	[kV]	6
Rated Voltage U_e		
AC 50/60 Hz	[V]	230, 240, 400, 415, 460, 500, 575, 690
DC	[V]	24, 48, 110, 220, 440
Insulation Class of the Coil		Class F per IEC 60085 Class 105 insulation system per UL 508
Rated coil frequency		AC 50/60 Hz, DC
Ambient Temperature		
Storage	[°C]	-55...+80
Operation at rated voltage	[°C]	-25...+60
at 70 °C		15% current reduction against 60 °C values
Climatic Withstand		IEC60068-2-30
Max. Altitude of Installation Site	[m]	2000 NN, per IEC60947-4
Protection Class		IP2X
Single contactor cover		—
Contactor with frame terminal block		—
Auxiliary contact		IP2X
Protection against Accidental Contact		—
Resistance to Shock		IEC60068-2
Resistance to Vibration		IEC60068-2
Mechanically Linked Contacts IEC60947-5-1, Annex L		100-K... (on main device)
Mirror Contacts IEC60947-4 Annex F		100-K...+100-KF...

Standards Compliance and Certifications

Standards Compliance	Certifications
IEC/EN 60947-1,-4-1,-5-1,-5-4	CE Marked
UL 508	CCC
CSA 22.2. No. 14	cULus Listed (File No. E41850, Guide NLDX, NLDX7)
NF F 62-000	
Meets the material restrictions for European Directive 2002/95/IEC-EU-RoHS	

Life-Load Curves

Figure 1 - AC-3, Switching of squirrel-cage motors while starting /AC-1, Non- or slightly inductive loads, resistance furnaces

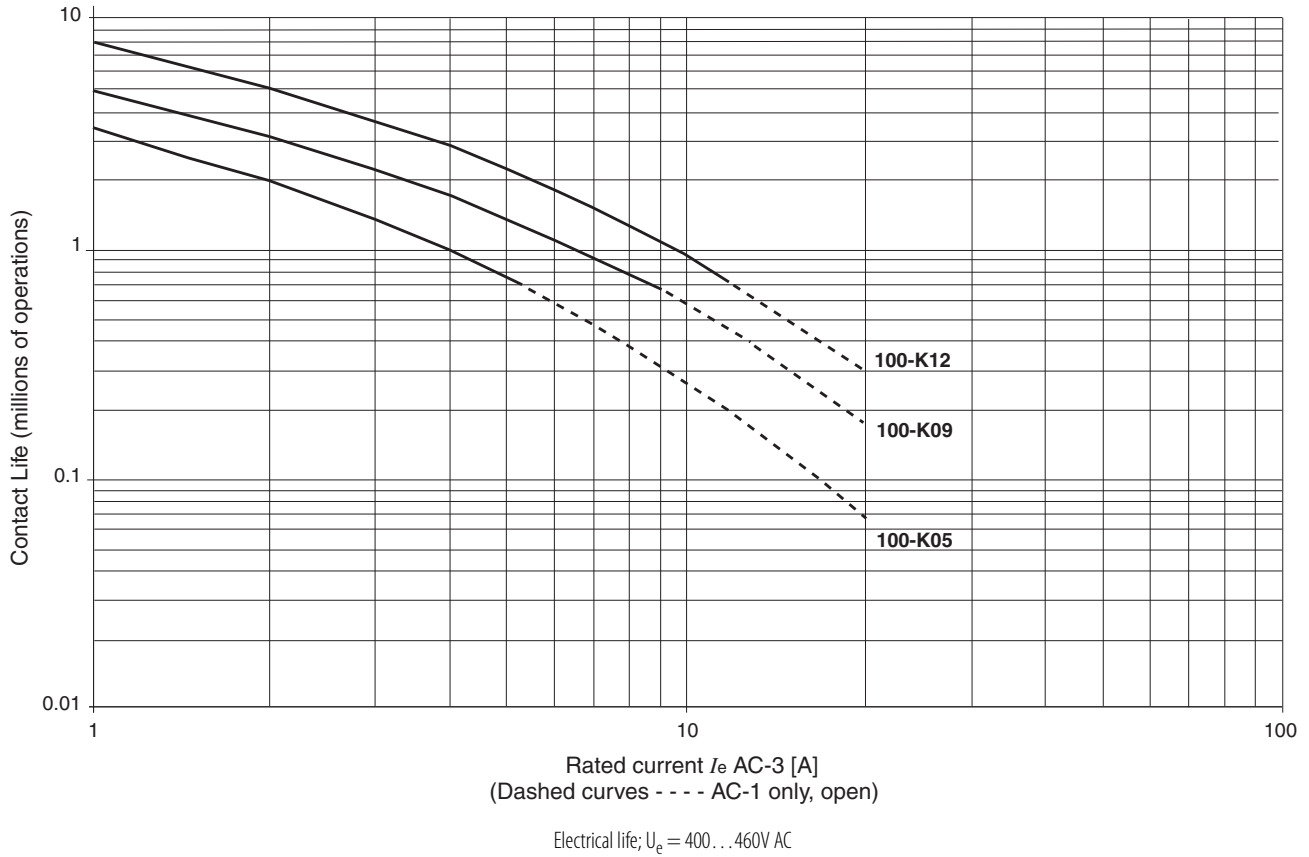
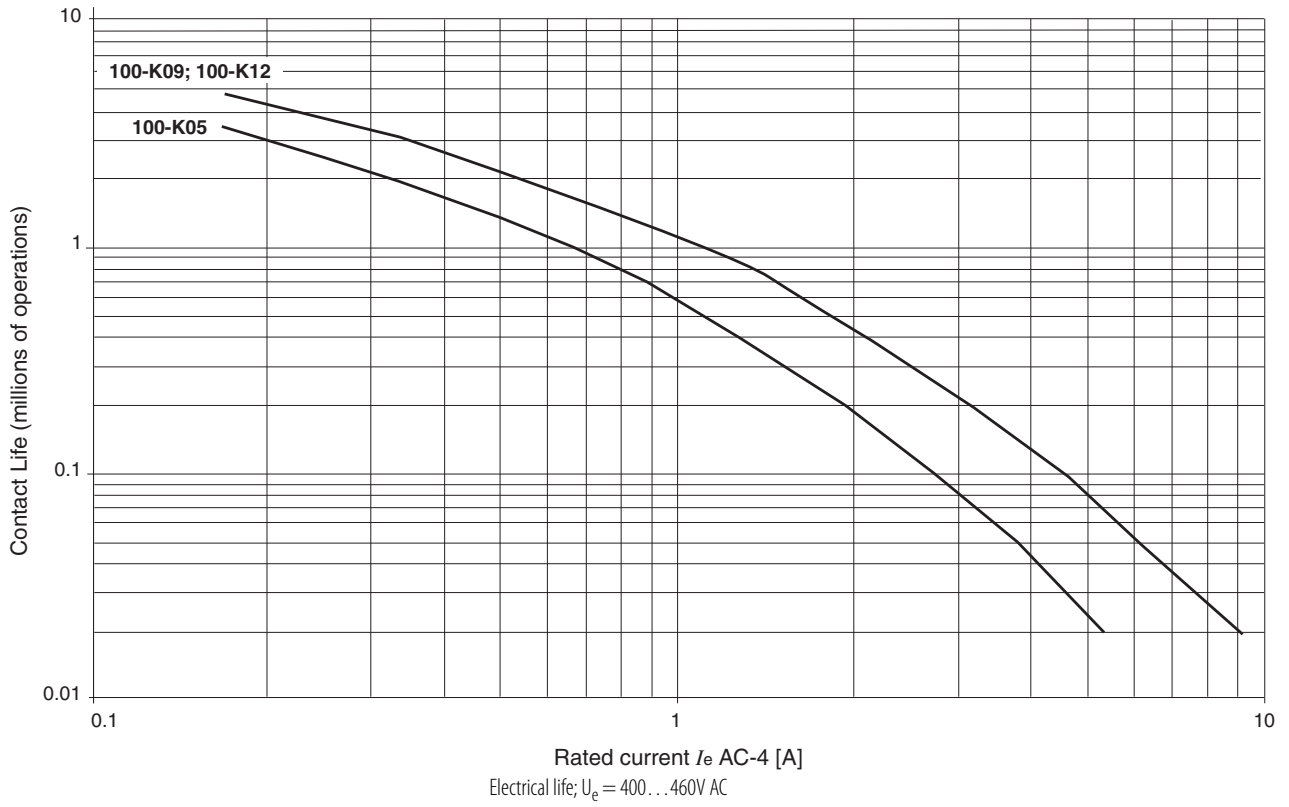

Figure 2 - AC-4, Stepping of squirrel-cage motors



Approximate Dimensions

Dimensions are shown in millimeters (inches). Dimensions are not intended for manufacturing purposes.

Figure 3 - 100-K Miniature Contactor with 193-K Overload Relay

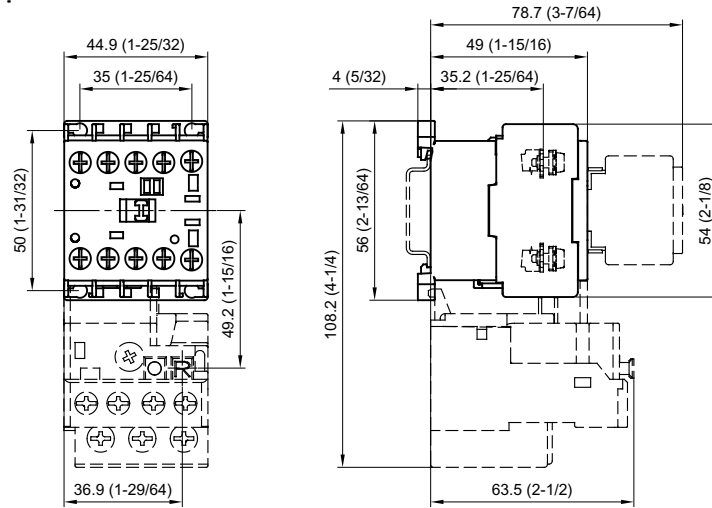
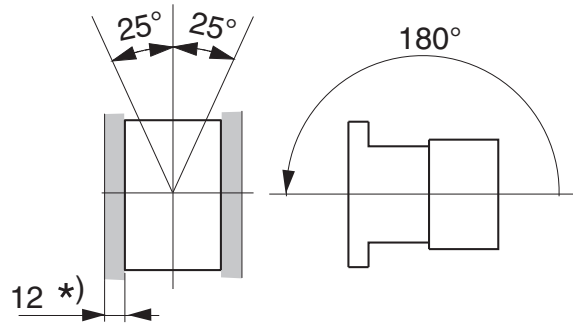

Figure 4 - Mounting Position



* - Minimum distance to grounded parts or walls

100-C/104-C, 100S-C/104S-C, 100Q-C Contactors

Coil Voltage Codes

100-C/104-C Contactors

The Cat. No. as listed is incomplete. Select a coil voltage code from the table below to complete the Cat. No. Example: 120V, 60 Hz: Cat. No. 100-C09 \otimes 10 becomes Cat. No.100-C09D10.

AC Voltages [V]	12	24	32	36	42	48	100	100... 110	110	120	127	200	200... 220	208	208... 240
50 Hz	R	K	V	W	X	Y	KP	—	D	P	S	KG	L	—	—
60 Hz	Q	J	—	V	—	X	—	KP	—	D	—	—	KG	H	L
50/60 Hz	—	KJ	—	—	—	KY	KP	—	KD	—	—	KG	KL ⁽¹⁾	—	—

(1) Not available on 100/104-C90 or -C97 contactors.

AC Voltages [V]	220... 230	230	230... 240	240	277	347	380	380... 400	400	400... 415	440	480	500	550	600
50 Hz	F	—	VA	T	—	—	—	N	—	G	B	—	M	C	—
60 Hz	—	—	—	A	T	I	E	—	—	—	N	B	—	—	C
50/60 Hz	KL ⁽¹⁾	KF	—	KA	—	—	—	—	KN	—	KB	—	—	—	—

(1) Not available on 100/104-C90 or -C97 contactors.

DC Voltages [V]		9	12	24	24	36	36...48	48	48...72	60	64
100-C09...C55	Electronic with Integrated Diode	—	EQ	EJ	QJ ⁽¹⁾	—	EW	—	EY	—	—
100-C60...C97	with Integrated Diode	DR	DQ	DJ	—	DW	—	DY	—	DZ	DB

(1) "QJ" coil has faster dropout time (16...21 ms).

DC Voltages [V]		72	80	110	110...125	115	125	220	220...250	230	250
100-C09...C55	Electronic with Integrated Diode	—	—	—	ED	—	—	—	EA	—	—
100-C60...C97	with Integrated Diode	DG	DE	DD	—	DP	DS	DA	—	DF	DT

Coil Terminal Position

All contactors are delivered with the coil terminals located on the line side.

For load side coil terminations, insert a "U" prior to the coil voltage code. Ordering example: Cat. No. 100-C09UD10.

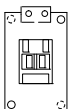

Cat. No.100-C09 \otimes 10 Line Side

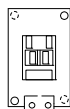

Cat. No.100-C09U \otimes 10 Load Side

100S-C/104S-C Safety Contactors

The Cat. No. as listed is incomplete. Select a coil voltage code from the table below to complete the Cat. No. Example: 120V, 60 Hz: Cat. No. 100S-C09⊗05BC becomes Cat. No.100S-C09D05BC.

AC Voltages [V]	12	24	32	36	42	48	100	100... 110	110	120	127	200	200... 220	208	208... 240
50 Hz	R	K	V	W	X	Y	KP	—	D	P	S	KG	L	—	—
60 Hz	Q	J	—	V	—	X	—	KP	—	D	—	—	KG	H	L
50/60 Hz	—	KJ	—	—	—	KY	KP	—	KD	—	—	KG	KL ⁽¹⁾	—	—

(1) Not available on 100S/104S-C97 contactors.

AC Voltages [V]	220... 230	230	230... 240	240	277	347	380	380... 400	400	400... 415	440	480	500	550	600
50 Hz	F	—	VA	T	—	—	—	N	—	G	B	—	M	C	—
60 Hz	—	—	—	A	T	I	E	—	—	—	N	B	—	—	C
50/60 Hz	KL ⁽¹⁾	KF	—	KA	—	—	—	—	KN	—	KB	—	—	—	—

(1) Not available on 100S/104S-C97 contactors.

DC Voltages [V]		9	12	24	24	36	36...48	48	48...72	60	64
100S-C09...C55	Electronic with Integrated Diode	—	EQ	EJ	QJ ⁽¹⁾	—	EW	—	EY	—	—
100S-C60...C97	with Integrated Diode	DR	DQ	DJ	—	DW	—	DY	—	DZ	DB

(1) "QJ" coil has faster dropout time (16...21 ms).

DC Voltages [V]		72	80	110	110...125	115	125	220	220...250	230	250
100S-C09...C55	Electronic with Integrated Diode	—	—	—	ED	—	—	—	EA	—	—
100S-C60...C97	with Integrated Diode	DG	DE	DD	—	DP	DS	DA	—	DF	DT

Coil Terminal Position

All contactors are delivered with the coil terminals located on the line side.

For load side coil terminations, insert a "U" prior to the coil voltage code. Ordering example: Cat. No. 100S-C09UD05BC.



Cat. No.100-C09⊗10 Line Side

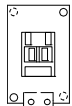

Cat. No.100-C09U⊗10 Load Side

100Q-C Contactors

The Cat. No. as listed is incomplete. Select a coil voltage code from the table below to complete the Cat. No. Example: 120V, 60 Hz: Cat. No. 100Q-C16⊗11 becomes Cat. No.100Q-C16D11.

AC Voltages [V]	12	24	32	36	42	48	100	100... 110	110	120	127	200	200... 220	208	208... 240
50 Hz	R	K	V	W	X	Y	KP	—	D	P	S	KG	L	—	—
60 Hz	Q	J	—	V	—	X	—	KP	—	D	—	—	KG	H	L
50/60 Hz	—	KJ	—	—	—	KY	KP	—	KD	—	—	KG	KL	—	—

AC Voltages [V]	220... 230	230	230... 240	240	277	347	380	380... 400	400	400... 415	440	480	500	550	600
50 Hz	F	—	VA	T	—	—	—	N	—	G	B	—	M	C	—
60 Hz	—	—	—	A	T	I	E	—	—	—	N	B	—	—	C
50/60 Hz	KL	KF	—	KA	—	—	—	—	KN	—	KB	—	—	—	—

DC Voltages [V]	9	12	24	36	48	60	64	72
Electronic with Integrated Diode	—	EQ	EJ	—	—	—	—	—

DC Voltages [V]	80	110	110...125	115	125	220	220...250	230	250
Electronic with Integrated Diode	—	—	ED	—	—	—	EA	—	—

Maximum Operational Rates

100Q-C16 200 operations/hour

100Q-C37 100 operations/hour

Assignment of Contacts

Device Combinations in Accordance with IEC 60947-1 / -4-1

Table valid for : AC / DC = 0.85...1.1 x U_S, T_{amb.} = -25 °C...+60 °C, normal position (horizontal rail mounting)

Auxiliary Contact Blocks		100-C Contactors (AC and DC Control)						
Circuit Diagram	Control	100-C09_⊗10 100-C12_⊗10 100-C16_⊗10 100-C23_⊗10	100-C09_⊗01 100-C12_⊗01 100-C16_⊗01 100-C23_⊗01	100-C30_⊗00 100-C37_⊗00 100-C43_⊗00 100-C55_⊗00 100-C60_⊗00 100-C72_⊗00 100-C85_⊗00 100-C97_⊗00	100-C09_⊗400 100-C12_⊗400 100-C16_⊗400 100-C23_⊗400 100-C40_⊗400 100-C90_⊗400	100-C09_⊗300 100-C12_⊗300 100-C16_⊗300 100-C23_⊗300	100-C09_⊗200 100-C12_⊗200 100-C16_⊗200 100-C23_⊗200 100-C40_⊗200 100-C90_⊗200	
Side Mounting ⁽¹⁾								
100-SB01		AC/DC	10 + 01 = 11	01 + 01 = 02 ⁽³⁾	00 + 01 = 01	00 + 01 = 01	00 + 01 = 01	00 + 01 = 01
100-SB10		AC/DC	10 + 10 = 20 ⁽³⁾	01 + 10 = 11	00 + 10 = 10	00 + 10 = 10	00 + 10 = 10	00 + 10 = 10
100-SB02		AC/DC	10 + 02 = 12 ⁽³⁾	—	00 + 02 = 02	00 + 02 = 02	00 + 02 = 02	00 + 02 = 02
100-SB11		AC/DC	10 + 11 = 21 ⁽³⁾	01 + 11 = 12 ⁽³⁾	00 + 11 = 11	00 + 11 = 11	00 + 11 = 11	00 + 11 = 11
100-SB20		AC/DC	10 + 20 = 30 ⁽³⁾	01 + 20 = 21 ⁽³⁾	00 + 20 = 20	00 + 20 = 20	00 + 20 = 20	00 + 20 = 20
100-SBL11 ⁽²⁾		AC/DC	10 + L11 = L21 ⁽³⁾	01 + L11 = L12 ⁽³⁾	00 + L11 = L11	00 + L11 = L11	00 + L11 = L11	00 + L11 = L11

(1) Up to 8 auxiliary contacts possible: contactor + front mounted (AC max. 4 N.C. / DC max. 4 N.C.), side mounted (AC max. 2 N.O. / DC max. 2 N.O. and max. 2 N.C.).

(2) Early make and/or late break.

(3) Double numbering: because of double numbering only left-side mounting is recommended.

Device Combinations in Accordance with IEC 60947-1 / -4-1

Auxiliary Contact Blocks		100-C Contactors (AC and DC Control)						
Circuit Diagram	Control	100-C09_⊗10	100-C09_⊗01	100-C30_⊗00 100-C37_⊗00 100-C43_⊗00 100-C55_⊗00 100-C60_⊗00 100-C72_⊗00 100-C85_⊗00 100-C97_⊗00	100-C09_⊗400 100-C12_⊗400 100-C16_⊗400 100-C23_⊗400 100-C40_⊗400 100-C90_⊗400	100-C09_⊗300 100-C12_⊗300 100-C16_⊗300 100-C23_⊗300	100-C09_⊗200 100-C12_⊗200 100-C16_⊗200 100-C23_⊗200 100-C40_⊗200 100-C90_⊗200	
Front Mounting⁽¹⁾								
100-FA02, 100-FAB02		AC/DC	10 + 02 = 12	01 + 02 = 03	00 + 02 = 02	00 + 02 = 02	00 + 02 = 02	00 + 02 = 02
100-FA11, 100-FAB11		AC/DC	10 + 11 = 21	01 + 11 = 12	00 + 11 = 11	00 + 11 = 11	00 + 11 = 11	00 + 11 = 11
100-FB11, 100-FBB11		AC/DC	—	—	00 + 11 = 11	00 + 11 = 11	00 + 11 = 11	00 + 11 = 11
100-FC11, 100-FCB11		AC/DC	10 + 11 = 21	—	—	—	—	—
100-FA20, 100-FAB20		AC/DC	10 + 20 = 30	01 + 20 = 21	00 + 20 = 20	00 + 20 = 20	00 + 20 = 20	00 + 20 = 20
100-FBL11 ⁽²⁾		AC/DC	—	—	00 + L11 = L11	00 + L11 = L11	00 + L11 = L11	00 + L11 = L11
100-FA22, 100-FAB22		AC/DC	10 + 22 = 32	01 + 22 = 23	00 + 22 = 22	00 + 22 = 22	00 + 22 = 22	00 + 22 = 22
100-FB22, 100-FBB22		AC/DC	—	—	00 + 22 = 22	00 + 22 = 22	00 + 22 = 22	00 + 22 = 22
100-FC22, 100-FCB22		AC/DC	10 + 22 = 32	—	—	—	—	—
100-FA31, 100-FAB31		AC/DC	10 + 31 = 41	01 + 31 = 32	00 + 31 = 31	00 + 31 = 31	00 + 31 = 31	00 + 31 = 31
100-FA40, 100-FAB40		AC/DC	10 + 40 = 50	01 + 40 = 41	00 + 40 = 40	00 + 40 = 40	00 + 40 = 40	00 + 40 = 40
100-FAL22 ⁽²⁾		AC/DC	10 + L22 = L32	01 + L22 = L23	00 + L22 = L22	00 + L22 = L22	00 + L22 = L22	00 + L22 = L22
100-FA04, 100-FAB04		AC/DC	10 + 04 = 14	01 + 04 = 05	00 + 04 = 04	00 + 04 = 04	00 + 04 = 04	00 + 04 = 04

Auxiliary Contact Blocks		100-C Contactors (AC and DC Control)						
Circuit Diagram	Control	100-C09_⊗10 100-C12_⊗10 100-C16_⊗10 100-C23_⊗10	100-C09_⊗01 100-C12_⊗01 100-C16_⊗01 100-C23_⊗01	100-C30_⊗00 100-C37_⊗00 100-C43_⊗00 100-C55_⊗00 100-C60_⊗00 100-C72_⊗00 100-C85_⊗00 100-C97_⊗00	100-C09_⊗400 100-C12_⊗400 100-C16_⊗400 100-C23_⊗400 100-C40_⊗400 100-C90_⊗400	100-C09_⊗300 100-C12_⊗300 100-C16_⊗300 100-C23_⊗300	100-C09_⊗200 100-C12_⊗200 100-C16_⊗200 100-C23_⊗200 100-C40_⊗200 100-C90_⊗200	
100-FA13, 100-FAB13		AC/DC	10 + 13 = 23	01 + 13 = 14	00 + 13 = 13	00 + 13 = 13	00 + 13 = 13	00 + 13 = 13
100-FB02, 100-FBB02		AC/DC	10 + 02 = 12	01 + 02 = 03	00 + 02 = 02	00 + 02 = 02	00 + 02 = 02	00 + 02 = 02
100-FB20, 100-FBB20		AC/DC	10 + 20 = 30	01 + 20 = 21	00 + 20 = 20	00 + 20 = 20	00 + 20 = 20	00 + 20 = 20
100-FC31, 100-FCB31		AC/DC	10 + 31 = 41	01 + 31 = 32	00 + 31 = 31	00 + 31 = 31	00 + 31 = 31	00 + 31 = 31

- (1) Up to 8 auxiliary contacts possible: contactor + front mounted (AC max. 4 N.C. / DC max. 4 N.C.), side mounted (AC max. 2 N.O. / DC max. 2 N.O. and max. 2 N.C.).
(2) Early make and/or late break.

Safety Contactors with 3 Main Contacts and Standard Front-Mount Auxiliary Contacts

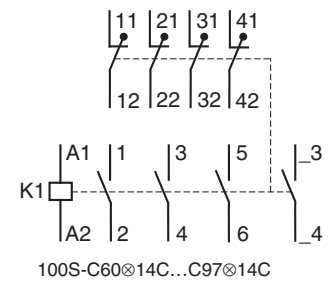
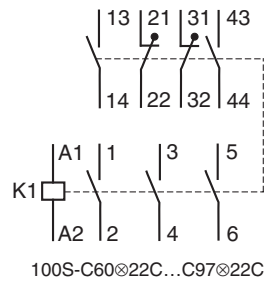
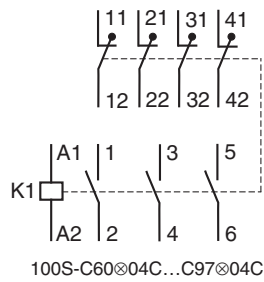
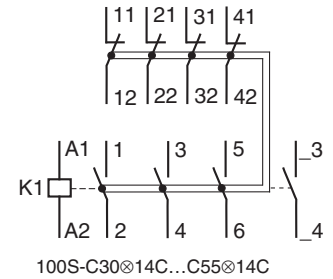
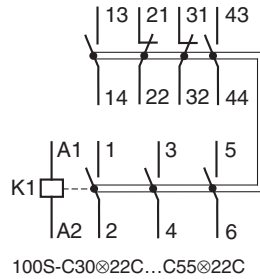
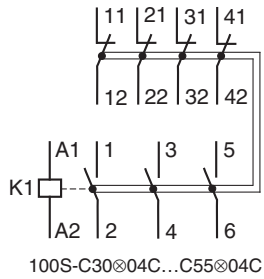
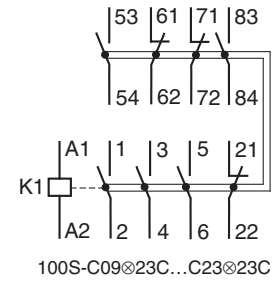
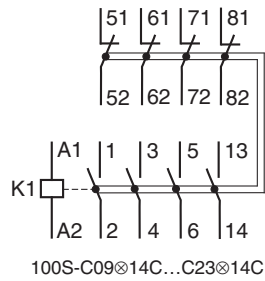
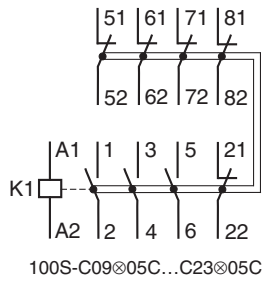

Safety Contactors with 4 Main Contacts and Standard Front-Mount Auxiliary Contacts

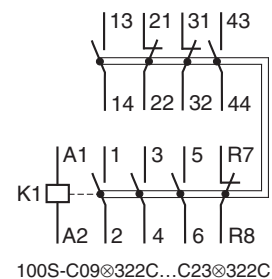
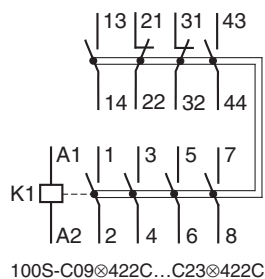
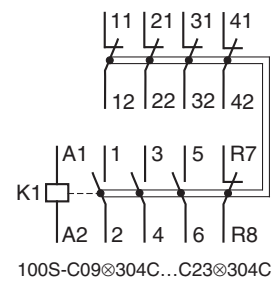
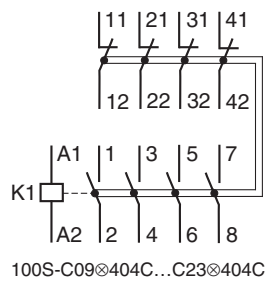

Safety Reversing Contactors with 3 Main Contacts and Standard Front-Mount Auxiliary Contacts

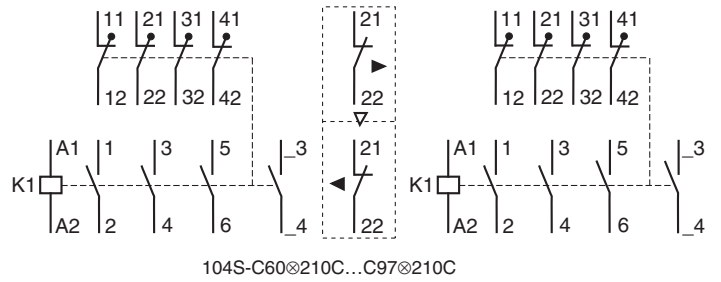
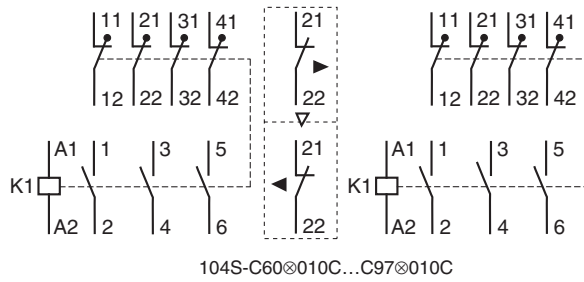
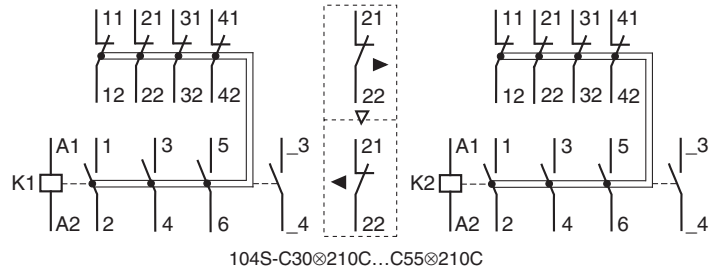
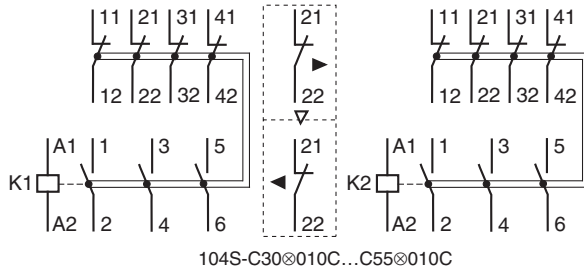
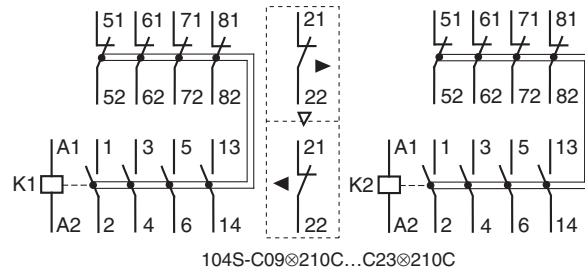
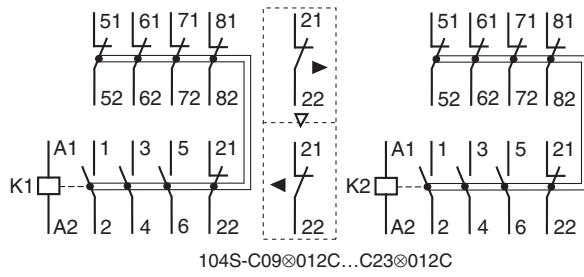

Safety Contactors with 3 Main Contacts and Bifurcated Front-Mount Auxiliary Contacts

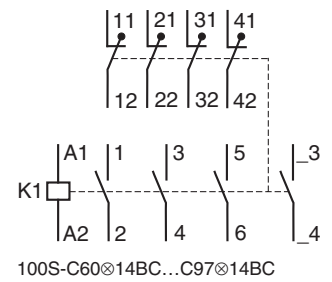
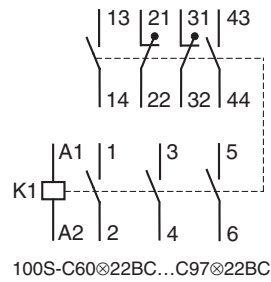
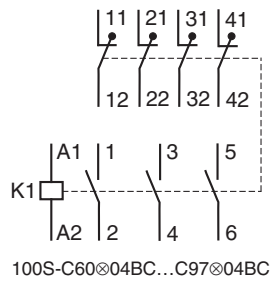
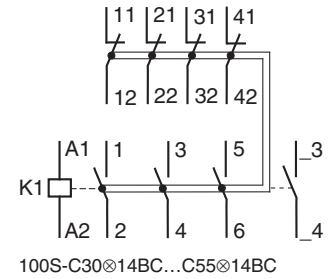
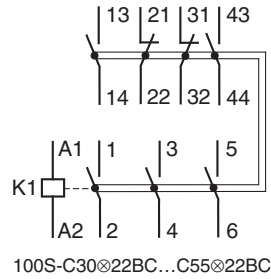
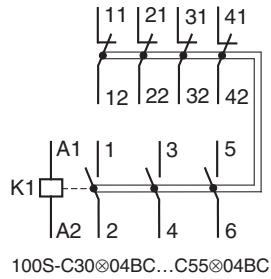
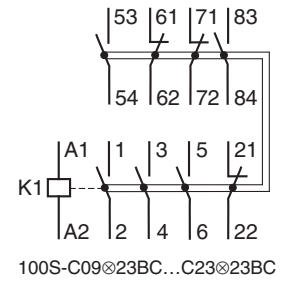
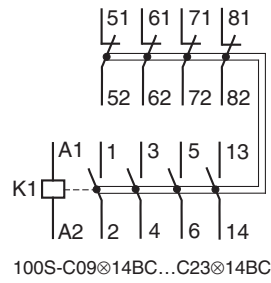
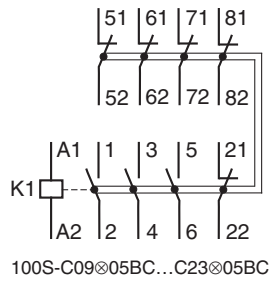

Safety Contactors with 4 Main Contacts and Bifurcated Front-Mount Auxiliary Contacts

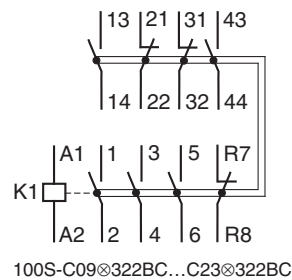
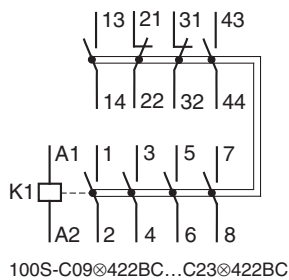
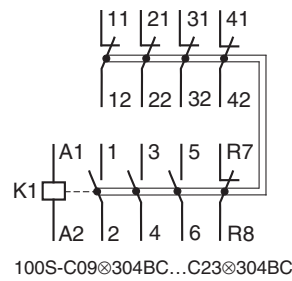
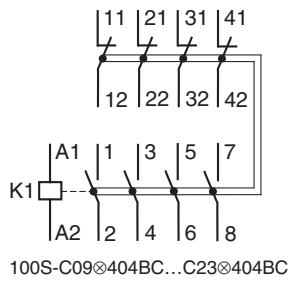

Safety Reversing Contactors with 3 Main Contacts and Bifurcated Front-Mount Auxiliary Contacts

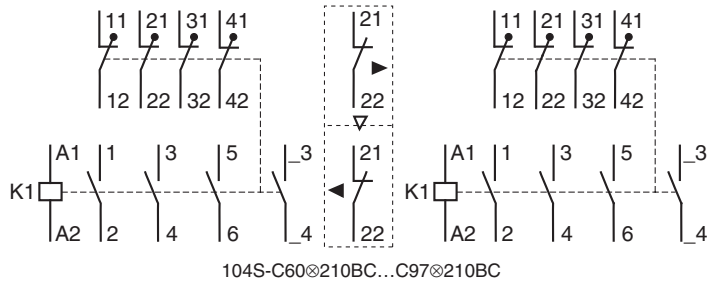
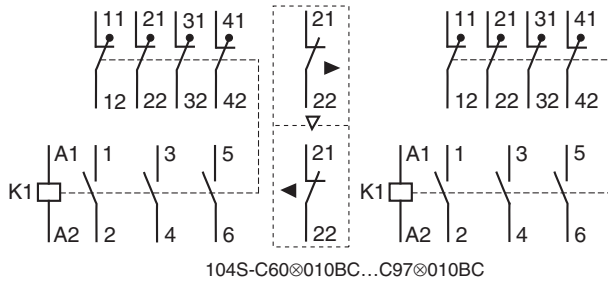
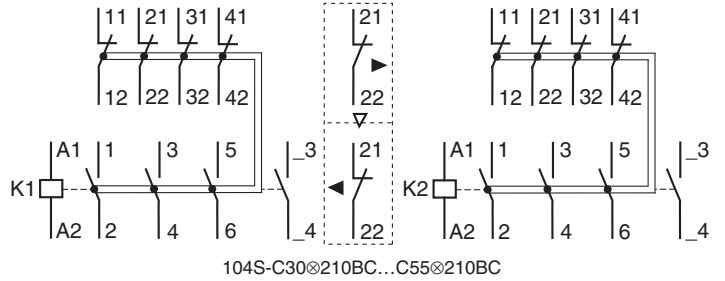
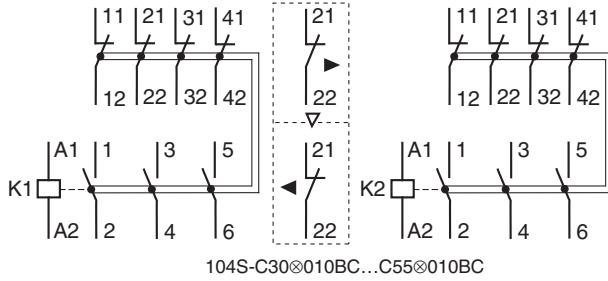
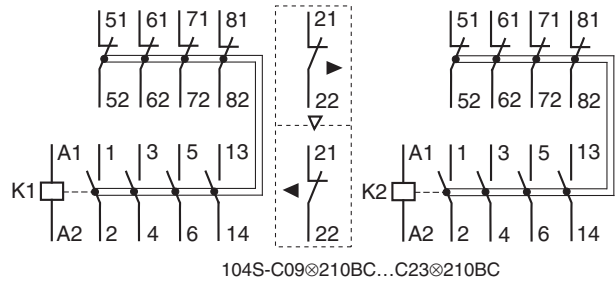
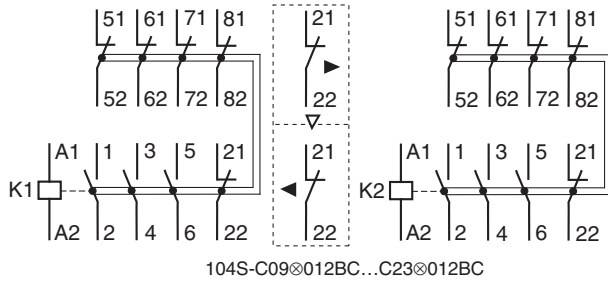

Specifications

			100/104-C, 100S/104S-C															
			09	12	16	23	30	37	40*200	40*400	43	55	60	72	85	90*200	90*400	97
Coil Type:	Conventional	X	X	X	X	X	X	X	X	X	X	X	X	X	X	X	X	
	Electronic — EI	X	X	X	X	X	X	X	X	X	X	X	—	—	—	—	—	
AC-1 Active Power Load (50 Hz); Ambient temperature 40 °C																		
Rated Operational Current, I_e	≤500V	[A]	32	32	32	32(40) ⁽¹⁾	65	65	75	75	85	85	100	100	100	130	130	130
	690V	[A]	32	32	32	32(40) ⁽¹⁾	65	65	75	75	85	85	100	100	100	130	130	130
	230V	[kW]	13	13	13	13	26	26	30	30	34	34	40	40	40	52	52	52
	240V	[kW]	13	13	13	13	27	27	31	31	35	35	42	42	42	54	54	54
	400V	[kW]	22	22	22	22	45	45	52	52	59	59	69	69	69	90	90	90
	415V	[kW]	23	23	23	23	47	47	54	54	61	61	72	72	72	93	93	93
	500V	[kW]	28	28	28	28	56	56	65	65	74	74	87	87	87	113	113	113
	690V	[kW]	38	38	38	38	78	78	90	90	102	102	120	120	120	155	155	155
AC-1 Active Power Load (50 Hz); Ambient temperature 60 °C																		
Rated Operational Current, I_e	≤500V	[A]	32	32	32	32	65	65	60	60	75	75	100	100	100	110	110	110
	690V	[A]	32	32	32	32	65	65	60	60	75	75	100	100	100	110	110	110
	230V	[kW]	13	13	13	13	26	26	24	24	25	25	40	40	40	44	44	44
	240V	[kW]	13	13	13	13	27	27	25	25	26	26	42	42	42	46	46	46
	400V	[kW]	22	22	22	22	45	45	42	42	44	44	69	69	69	76	76	76
	415V	[kW]	23	23	23	23	47	47	43	43	45	45	72	72	72	79	79	79
	500V	[kW]	28	28	28	28	56	56	52	52	55	55	87	87	87	95	95	95
	690V	[kW]	38	38	38	38	78	78	72	72	75	75	120	120	120	131	131	131
Switching of 3-phase Motors; (50 Hz) Ambient temperature 60 °C, AC-2, AC-3																		
Rated Operational Current, I_e	230V	[A]	12	15	20	26.5	35	38	38	38	44	56	62	72	85	85	85	96
	240V	[A]	12	15	20	26.5	35	38	38	38	44	56	62	72	85	85	85	95
	400V	[A]	9	12	16	23	30	37	37	37	43	55	60	72	85	85	85	97
	415V	[A]	9	12	16	23	30	37	37	37	43	55	60	72	85	85	85	97
	500V	[A]	7	10	14	20	25	30	29	30	38	44	55	67	80	80	80	78
	690V	[A]	5	7	9	12	18	21	9	21	25	25	34	42	49	22	49	57
	230V	[kW]	3	4	5.5	7.5	10	11	11	11	13	15	18.5	22	25	25	25	30
	240V	[kW]	3	4	5.5	7.5	10	11	11	11	13	15	18.5	22	25	25	25	30
	400V	[kW]	4	5.5	7.5	11	15	18.5	18.5	18.5	22	30	32	40	45	45	45	55
	415V	[kW]	4	5.5	7.5	11	15	20	20	20	22	30	32	40	45	45	45	55
	500V	[kW]	4	5.5	7.5	13	15	20	18.5	20	25	30	37	45	55	55	55	55
	690V	[kW]	4	5.5	7.5	10	15	18.5	7.5	18.5	22	22	32	40	45	18.5	45	55
Load Carrying Capacity per UL/CSA																		
General Purpose Current (enclosed)		[A]	25	25	30	30	55	60	60	60	75	75	90	90	100	125	130	120
Rated power (enclosed) 1-phase	115V	[A]	9.8	9.8	16	24	24	34	34	34	34	56	56	56	80	80	80	100
	230V	[A]	10	12	17	17	28	28	28	28	40	50	50	68	68	68	68	88
	115V	[Hp]	0.5	0.5	1	2	2	3	3	3	3	5	5	5	7.5	7.5	7.5	10
	230V	[Hp]	1.5	2	3	3	5	5	5	5	7.5	10	10	15	15	15	15	20
Rated power (enclosed) 3-phase	200V	[A]	7.8	11	17.5	17.5	25.3	32.2	32.2	32.2	32.2	48.3	48.3	62.1	78.2	78.2	78.2	92
	230V	[A]	6.8	9.6	15.2	22	28	28	28	28	42	54	54	68	80	80	80	80
	460V	[A]	7.6	11	14	21	27	34	34	34	40	52	52	65	77	65	77	96
	575V	[A]	9	11	17	17	27	32	17	32	32	41	52	62	62	22	52	77
	200V	[Hp]	2	3	5	5	7.5	10	10	10	10	15	15	20	25	25	25	30
	230V	[Hp]	2	3	5	7.5	10	10	10	10	15	20	20	25	30	30	30	30
	460V	[Hp]	5	7.5	10	15	20	25	25	25	30	40	40	50	60	50	60	75
575V	[Hp]	7.5	10	15	15	25	30	15	30	30	40	50	60	60	20	50	75	

(1) Values in () with increased cross-section and cable lug

			100/104-C, 100S/104S-C											
			09	12	16	23	30	37	43	55	60	72	85	97
Coil Type:	Conventional		X	X	X	X	X	X	X	X	X	X	X	X
	Electronic — EI		X	X	X	X	X	X	X	X	X	—	—	—
Switching of 3-phase Motors, (50 Hz); Ambient temperature 60 °C, AC-4														
	230V	[A]	12	15	20	26.5	35	38	44	56	62	72	85	96
	240V	[A]	12	15	20	26.5	35	38	44	56	62	72	85	95
	400V	[A]	9	12	16	23	30	37	43	55	60	72	85	97
	415V	[A]	9	12	16	23	30	37	43	55	60	72	85	97
	500V	[A]	7	10	14	20	25	30	38	44	55	67	80	78
	690V	[A]	5	7	9	12	18	21	25	25	34	42	49	57
	230V	[kW]	3	4	5.5	7.5	10	11	13	15	18.5	22	25	30
	240V	[kW]	3	4	5.5	7.5	10	11	13	15	18.5	22	25	30
	400V	[kW]	4	5.5	7.5	11	15	18.5	22	30	32	40	45	55
	415V	[kW]	4	5.5	7.5	11	15	20	22	30	32	40	45	55
	500V	[kW]	4	5.5	7.5	13	15	20	25	30	37	45	55	55
	690V	[kW]	4	5.5	7.5	10	15	18.5	22	22	32	40	45	55
AC-4 at approximately 200,000 operations														
	230V	[A]	4.3	6.6	9	9	12	14	16.5	22	25.5	31	38	44
	240V	[A]	4.3	6.6	9	9	12	14	16.5	22	25.5	31	38	44
	400/415V	[A]	4.3	6.6	9	9	12	14	16.5	22	25.5	31	38	44
	500V	[A]	4.3	6.6	9	9	12	14	16.5	22	25.5	31	38	44
	690V	[A]	4.3	6.6	9	9	12	14	16.5	22	25.5	31	38	44
	230V ⁽¹⁾	[kW]	0.75	1.5	2.2	2.2	3	3.7	4	5.5	6.3	7.5	11	11
	240V ⁽¹⁾	[kW]	0.75	1.5	2.2	2.2	3	4	4	5.5	7.5	7.5	11	11
	400V ⁽¹⁾	[kW]	1.8	3	4	4	5.5	6.3	7.5	11	13	15	20	22
	415V ⁽¹⁾	[kW]	1.8	3	4	4	5.5	6.3	7.5	11	13	17	20	22
	500V ⁽¹⁾	[kW]	2.2	3.7	5.5	5.5	7.5	7.5	10	11	15	20	25	30
	690V ⁽¹⁾	[kW]	3	5.5	7.5	7.5	10	11	15	18.5	22	25	32	37
Max. switching frequency		Ops/hour	250	250	220	200	200	200	200	200	120	120	120	120
Wye-Delta (60 Hz)														
	200V	[Hp]	5	5	7½	7½	10	15	20	25	30	40	50	50
	230V	[Hp]	5	7½	10	10	15	20	25	30	40	50	60	60
	460V	[Hp]	10	15	20	25	30	40	50	60	75	100	125	125
	575V	[Hp]	10	15	20	25	30	40	50	60	75	100	125	125
UL/CSA Elevator Duty														
	200V	[A]	7.8	11.0	11.0	17.5	25.3	25.3	32.2	TBD	32.2	48.3	62.1	TBD
	230V	[A]	6.8	9.6	15.2	15.2	22.0	28.0	28.0	TBD	42.0	54.0	68.0	TBD
	460V	[A]	7.6	11.0	04.0	21.0	27.0	27.0	34.0	TBD	40.0	52.0	65.0	TBD
	575V	[A]	6.1	9.0	11.0	17.0	22.0	27.0	32.0	TBD	41.0	52.0	62.0	TBD
	200V	[Hp]	2	3	3	5	7-1/2	7-1/2	10	TBD	10	15	20	TBD
	230V	[Hp]	2	3	5	5	7-1/2	10	10	TBD	15	20	25	TBD
	460V	[Hp]	5	7-1/2	10	15	20	20	25	TBD	30	40	50	TBD
	575V	[Hp]	5	7-1/2	10	15	20	25	30	TBD	40	50	60	TBD

(1) Power ratings at 50 Hz; Preferred values according to IEC 60072-1

		100/104-C, 100S/104S-C											
		09	12	16	23	30	37	43	55	60	72	85	97
Coil Type:	Conventional	X	X	X	X	X	X	X	X	X	X	X	X
	Electronic — EI	X	X	X	X	X	X	X	X	—	—	—	—

Star-Delta Starting (50 Hz)														
	≤ 230V	[A]	21	26	35	46	61	66	76	96	107	125	147	166
	≤ 240V	[A]	21	26	35	46	61	66	76	96	107	125	147	165
	400V	[A]	16	21	28	40	52	64	74	95.3	104	125	147	168
	415V	[A]	16	21	28	40	52	64	74	95.3	104	125	147	168
	500V	[A]	12	17	24	35	43	52	66	76.2	95	116	139	135
	690V	[A]	8.6	12	16	21	31	36	43	55.4	59	73	85	99
	230V ⁽¹⁾	[kW]	5.5	7.5	10	13	17	20	22	30	32	37	45	50
	240V ⁽¹⁾	[kW]	5.5	7.5	10	13	18.5	20	22	30	32	40	50	50
	400V ⁽¹⁾	[kW]	7.5	10	13	20	25	32	40	45	55	63	80	90
	415V ⁽¹⁾	[kW]	7.5	11	15	22	25	37	40	45	55	63	80	90
	500V ⁽¹⁾	[kW]	7.5	11	15	22	25	32	45	45	63	80	90	90
	690V ⁽¹⁾	[kW]	7.5	10	13	18.5	25	32	40	45	55	63	80	90

Switching of Power Transformers, AC-6a (50 Hz)

Inrush Current	Rated transformer current	=n												
n=30	≤ 230V	[A]	10.9	10.9	10.9	10.9	20	20	23	23	40.8	40.8	40.8	48.5
	≤ 240V	[A]	10.9	10.9	10.9	10.9	20	20	23	23	40.8	40.8	40.8	48.5
	≤ 400V	[A]	10.9	10.9	10.9	10.9	20	20	23	23	40.8	40.8	40.8	48.5
	≤ 415V	[A]	10.9	10.9	10.9	10.9	20	20	23	23	40.8	40.8	40.8	48.5
	≤ 500V	[A]	10.9	10.9	10.9	10.9	20	20	23	23	40.8	40.8	40.8	48.5
	≤ 690V	[A]	10.9	10.9	10.9	10.9	20	20	23	23	40.8	40.8	40.8	48.5
	230V	[kVA]	4.3	4.3	4.3	4.3	8	8	9.2	9.2	16	16	16	19.3
	240V	[kVA]	4.5	4.5	4.5	4.5	8.3	8.3	10	10	17	17	17	20.2
	400V	[kVA]	7.5	7.5	7.5	7.5	14	14	16	16	28	28	28	33.6
	415V	[kVA]	7.8	7.8	7.8	7.8	14	14	17	17	29	29	29	34.9
	500V	[kVA]	9.4	9.4	9.4	9.4	17	17	20	20	35	35	35	42
	690V	[kVA]	13	13	13	13	24	24	27	27	49	49	49	58
n=20	≤ 690V	[A]	16.3	16.3	16.3	16.3	30	30	34.5	34.5	61.3	61.3	61.3	72.8
n=15	≤ 690V	[A]	22	22	22	22	40	40	46	46	82	82	82	97

60 Hz Peak Inrush/peak rated transformer current

n=30	n=30	[A]	10.9	10.9	10.9	10.9	20	20	23	23	40.8	40.8	40.8	48.5
	200V	[kVA]	3.8	3.8	3.8	3.8	6.9	6.9	8.0	8	14.1	14.4	14.4	16.8
	208V	[kVA]	3.9	3.9	3.9	3.9	7.2	7.2	8.3	8.3	14.7	14.7	14.7	17.5
	240V	[kVA]	4.5	4.5	4.5	4.5	8.3	8.3	9.6	9.6	17.0	17.0	17.0	20.2
	480V	[kVA]	9.1	9.1	9.1	9.1	16.6	16.6	19.1	19.1	33.9	33.9	33.9	40.3
	600V	[kVA]	11.3	11.3	11.3	11.3	20.8	20.8	23.9	23.9	42.4	42.4	42.4	50.4
	660V	[kVA]	12.5	12.5	12.5	12.5	22.9	22.9	26.3	26.3	46.6	46.6	46.6	55.4

60 Hz Peak Inrush/peak rated transformer current

n=20	n=20	[A]	16.3	16.3	16.3	16.3	30	30	34.5	34.5	61.3	61.3	61.3	72.8
	200V	[kVA]	5.6	5.6	5.6	5.6	10.4	10.4	12.0	12	21.2	21.2	21.2	25.2
	208V	[kVA]	5.9	5.9	5.9	5.9	10.8	10.8	12.4	12.4	22.1	22.1	22.1	26.2
	240V	[kVA]	6.8	6.8	6.8	6.8	12.5	12.5	14.3	14.3	25.5	25.5	25.5	30.3
	480V	[kVA]	13.6	13.6	13.6	13.6	24.9	24.9	28.7	28.7	51.0	51.0	51.0	60.5
	600V	[kVA]	16.9	16.9	16.9	16.9	31.2	31.2	35.9	35.9	63.7	63.7	63.7	75.7
	660V	[kVA]	18.6	18.6	18.6	18.6	34.3	34.3	39.4	39.4	70.1	70.1	70.1	83.2

(1) Power ratings at 50 Hz: Preferred values according to IEC 60072-1

			100/104-C, 100S/104S-C												
			09	12	16	23	30	37	43	55	60	72	85	97	
Coil Type:	Conventional	X	X	X	X	X	X	X	X	X	X	X	X	X	X
	Electronic — EI	X	X	X	X	X	X	X	X	X	X	—	—	—	—

60 Hz Peak Inrush/peak rated transformer current

	n=15	[A]	100/104-C, 100S/104S-C												
			09	12	16	23	30	37	43	55	60	72	85	97	
200V	[kVA]	7.5	7.5	7.5	7.5	13.9	13.9	15.9	15.9	28.4	28.4	28.4	33.6		
208V	[kVA]	7.8	7.8	7.8	7.8	14.4	14.4	16.6	16.6	29.5	29.5	29.5	34.9		
240V	[kVA]	9.0	9.0	9.0	9.0	16.6	16.6	19.1	19.1	34.1	34.1	34.1	40.3		
480V	[kVA]	18.1	18.1	18.1	18.1	33.3	33.3	38.2	38.2	68.2	68.2	68.2	80.6		
600V	[kVA]	22.6	22.6	22.6	22.6	41.6	41.6	47.8	47.8	85.2	85.2	85.2	100.8		
660V	[kVA]	24.9	24.9	24.9	24.9	45.7	45.7	52.6	52.6	93.7	93.7	93.7	110.9		

			100/104-C, 100S/104S-C														
			09	12	16	23	30	37	40*200	40*400	43	55	60	72	85	90*200	90*400
Coil Type:	Conventional	X	X	X	X	X	X	X	X	X	X	X	X	X	X	X	X
	Electronic — EI	X	X	X	X	X	X	X	X	X	X	X	—	—	—	—	—

Switching of 3-phase Capacitors, AC-6b (50 Hz)⁽¹⁾

	Voltage	[kVar]	100/104-C, 100S/104S-C															
			09	12	16	23	30	37	40*200	40*400	43	55	60	72	85	90*200	90*400	97
Single capacitor 40°C	230V	[kVar]	8	8	8.5	9	14	14	—	—	24	24	28	28	28	—	—	28
	240V	[kVar]	8	8	8.5	9	14	14	—	—	25	25	29	29	29	—	—	29
	400V	[kVar]	8	8	10	12.5	20	24	—	—	35	35	48	48	48	—	—	48
	415V	[kVar]	8	8	10	12.5	20	25	—	—	35	35	50	50	50	—	—	50
	500V	[kVar]	8	8	10	12.5	20	25	—	—	35	35	50	55	60	—	—	60
	690V	[kVar]	8	8	10	12.5	20	25	—	—	35	35	50	55	60	—	—	60
Single capacitor 60 °C	230V	[kVar]	8	8	8.5	9	12.5	12.5	—	—	18	18	28	28	28	—	—	28
	240V	[kVar]	8	8	8.5	9	12.5	12.5	—	—	18	18	29	29	29	—	—	29
	400V	[kVar]	8	8	10	12.5	20	21.5	—	—	30	30	42	48	48	—	—	48
	415V	[kVar]	8	8	10	12.5	20	22	—	—	30	30	42	50	50	—	—	50
	500V	[kVar]	8	8	10	12.5	20	25	—	—	30	30	42	50	55	—	—	55
	690V	[kVar]	8	8	10	12.5	20	25	—	—	30	30	42	50	55	—	—	55
Group capacitors 40°C	230V	[kVar]	5	5	8	9	12.5	14	—	—	20	20	28	28	28	—	—	28
	240V	[kVar]	5	5	8	9	12.5	14	—	—	20	20	29	29	29	—	—	29
	400V	[kVar]	5	5	8	10	15	20	—	—	25	25	40	48	48	—	—	48
	415V	[kVar]	5	5	8	10	15	20	—	—	25	25	40	50	50	—	—	50
	500V	[kVar]	5	5	8	10	15	20	—	—	25	25	40	50	50	—	—	50
	690V	[kVar]	5	5	8	10	15	20	—	—	25	25	40	50	50	—	—	50
Group capacitors 60 °C	230V	[kVar]	5	5	8	9	12.5	12.5	—	—	18	18	28	28	28	—	—	28
	240V	[kVar]	5	5	8	9	12.5	12.5	—	—	18	18	29	29	29	—	—	29
	400V	[kVar]	5	5	8	10	15	20	—	—	25	25	40	48	48	—	—	48
	415V	[kVar]	5	5	8	10	15	20	—	—	25	25	40	50	50	—	—	50
	500V	[kVar]	5	5	8	10	15	20	—	—	25	25	40	50	50	—	—	50
	690V	[kVar]	5	5	8	10	15	20	—	—	25	25	40	50	50	—	—	50
60 Hz Single Capacitor — 40 °C	200V	[kVar]	5	5	8	9	12.5	14	—	—	20	20	28	28	28	—	—	28
	230V	[kVar]	5	5	8	9	12.5	14	—	—	20	20	29	29	29	—	—	29
	460V	[kVar]	5	5	8	10	15	20	—	—	25	25	40	50	50	—	—	50
	600V	[kVar]	5	5	8	10	15	20	—	—	25	25	40	50	50	—	—	50
60 Hz Group Capacitors — 40 °C	200V	[kVar]	5	5	8	9	12.5	12.5	—	—	18	18	28	28	28	—	—	28
	230V	[kVar]	5	5	8	9	12.5	12.5	—	—	18	18	29	29	29	—	—	29
	460V	[kVar]	5	5	8	10	15	20	—	—	25	25	40	50	50	—	—	50
	600V	[kVar]	5	5	8	10	15	20	—	—	25	25	40	50	50	—	—	50

(1) Inductance of leads between capacitors in parallel: min. 6 μH (100-C09...C30 contactors: min 30 μH)

		100/104-C, 100S/104S-C															
		09	12	16	23	30	37	40*200	40*400	43	55	60	72	85	90*200	90*400	97
Coil Type:	Conventional	X	X	X	X	X	X	X	X	X	X	X	X	X	X	X	X
	Electronic — EI	X	X	X	X	X	X	X	X	X	X	X	—	—	—	—	—

Switching of Lamps

Gas discharge lamps AC-5a, 40 °C

open	[A]	22.5	25	28	29	40.5	45	65	65	77	77	81	85	90	115	115	115
enclosed	[A]	22.5	25	28	29	37	41	54	54	57	57	77	81	90	95	95	100

Individually compensated:

Max. capacitance at expected

Short-circuit current of	10 kA	[μF]	1000	1000	1000	1000	2700	2700	—	—	3200	3200	4000	4000	4700	—	—	4700
	20 kA	[μF]	500	500	500	500	1350	1350	—	—	1600	1600	2000	2000	2350	—	—	2350
	50 kA	[μF]	200	200	200	200	540	540	—	—	640	640	800	800	940	—	—	940
Filament AC-5b	230/240V	[A]	12	16	18	22	30	37	18	25	43	51	60	70	76	60	75	90

Switching of Low Inductive Loads in Home Appliances and Similar Applications per IEC 61095 (50 Hz)

AC-7a	230V	[A]	32	32	32	32	45	45	—	—	63	63	—	—	—	—	—	—
	400V	[A]	32	32	32	32	45	45	—	—	63	63	—	—	—	—	—	—
	440V	[A]	32	32	32	32	45	45	—	—	63	63	—	—	—	—	—	—

Switching of Motor Load for Home Appliances (50 Hz)

AC-7b	230V	[A]	10.5	14	19	23	30	—	—	—	—	—	—	—	—	—	—	—
	400V	[A]	9	12	16	20	30	—	—	—	—	—	—	—	—	—	—	—
	440V	[A]	7.5	10	13.5	18	27	—	—	—	—	—	—	—	—	—	—	—

Switching of Hermetically Sealed Cooling Compressor Motors - manual reset of overload release (50 Hz)

AC-8a	400V	[A]	12	16	22	32	38	45	—	—	63	63	72	85	100	—	—	115
	500V	[A]	12	16	22	32	38	45	—	—	63	63	72	85	100	—	—	115
	690V	[A]	8	10	14	20	28	35	—	—	42	42	56	67	80	—	—	90

- automatic reset of overload release

AC-8b	400V	[A]	5.5	7	9.3	12	13	14	—	—	16	16	24	30	35	—	—	35
	500V	[A]	5.5	7	9.3	12	13	14	—	—	16	16	24	30	35	—	—	35
	690V	[A]	5.5	7	9.3	12	13	14	—	—	16	16	24	30	35	—	—	35

Switching of DC Loads

Non-inductive or slightly inductive loads or resistance furnaces DC-1, 60 °C

1 pole	24V	[A]	25	25	32	32	45	45	45	45	50	50	70	80	80	80	80	80
	48/60V	[A]	20	20	20	20	25	25	25	25	30	30	40	40	40	40	40	40
	110V	[A]	6	6	6	6	8	8	10	10	9	9	11	11	11	11	11	11
	220V	[A]	1.5	1.5	1.5	1.5	1.5	1.5	1.5	1.5	1.5	1.5	2	2	2	1.8	1.8	2
	440V	[A]	0.4	0.4	0.4	0.4	0.4	0.4	0.4	0.4	0.5	0.5	0.5	0.5	0.5	0.5	0.5	0.5
2 poles in series	24V	[A]	25	25	32	32	45	45	45	45	50	50	70	80	80	80	80	80
	48/60V	[A]	25	25	32	32	45	45	45	45	50	50	70	80	80	80	80	80
	110V	[A]	25	25	32	32	45	45	45	45	50	50	70	80	80	80	80	80
	220V	[A]	8	8	8	10	10	10	10	10	10	10	15	15	15	15	15	15
	440V	[A]	1	1	1	1	1	1	1	1	1	1	1.5	1.5	1.5	1.5	1.5	1.5
3 poles in series	24V	[A]	25	25	32	32	45	45	—	—	63	63	90	90	100	—	100	100
	48/60V	[A]	25	25	32	32	45	45	—	—	50	50	70	90	100	—	100	100
	110V	[A]	20	20	25	25	30	30	—	—	35	35	70	90	100	—	100	100
	220V	[A]	6	6	6	10	15	15	—	—	20	20	25	80	80	—	80	80
	440V	[A]	0.6	0.6	0.6	0.6	0.6	0.6	—	—	0.6	0.6	0.6	5	5	—	5	5

		100/104-C, 100S/104S-C															
		09	12	16	23	30	37	40*200	40*400	43	55	60	72	85	90*200	90*400	97
Coil Type:	Conventional	X	X	X	X	X	X	X	X	X	X	X	X	X	X	X	X
	Electronic — EI	X	X	X	X	X	X	X	X	X	X	X	—	—	—	—	—

Switching of DC Loads, Continued

Series-wound Motors, Starting, reverse current braking, reversing, stepping DC-3, 60 °C

3 poles in series	24V	[A]	25	25	32	32	45	45	—	—	63	63	90	90	100	—	—	100
	48/60V	[A]	25	25	32	32	45	45	—	—	50	50	70	70	80	—	—	80
	110V	[A]	20	20	25	25	30	30	—	—	35	35	70	70	80	—	—	80
	220V	[A]	6	6	6	10	15	15	—	—	20	20	25	25	30	—	—	30
	440V	[A]	0.6	0.6	0.6	0.6	0.6	0.6	—	—	0.6	0.6	0.6	0.6	0.6	—	—	0.6

Series-wound Motors, Starting, reverse current braking, reversing, stepping DC-5, 60 °C

3 poles in series	24V	[A]	25	25	32	32	45	45	—	—	63	63	90	90	100	—	—	100
	48/60V	[A]	25	25	32	32	45	45	—	—	50	50	70	70	80	—	—	80
	110V	[A]	20	20	25	25	30	30	—	—	35	35	70	70	80	—	—	80
	220V	[A]	6	6	6	10	15	15	—	—	20	20	25	25	30	—	—	30
	440V	[A]	0.6	0.6	0.6	0.6	0.6	0.6	—	—	0.6	0.6	0.6	0.6	0.6	—	—	0.6

Short Time Withstand I_{CW} , 60 °C	10 s	[A]	170	170	170	215	300	304	304	304	375	375	700	700	700	700	700	840
--	------	-----	-----	-----	-----	-----	-----	-----	-----	-----	-----	-----	-----	-----	-----	-----	-----	-----

Resistance and Power Dissipation



Main current circuit resistance	[mΩ]	2.7	2.7	2.7	2	2	2	2	1.5	1.5	1	0.9	0.9	0.9	0.8	0.7	0.6	
Power dissipation by all circuits at I_e AC-3/400V	[W]	0.66	1.2	2.1	3.2	5.4	8.2	11.3	8.4	8.3	9.1	9.7	14	19.5	13.5	11.8	17	
Total power dissipation At I_e AC-3/400V	AC control	[W]	3.4	3.9	4.8	6.3	8.5	11.3	8.8	9.5	11.6	12.4	16.2	13.8	17.5	36	56.3	26
	DC control (conv.)	[W]	—	—	—	—	—	—	—	—	—	—	13.7	13.8	17.5	32.5	52.8	23
	DC control (elect.)	[W]	2.4	2.9	3.8	4.9	7.1	9.9	8	8.7	10.8	11.6	—	—	—	—	—	—

Lifespan

Mechanical AC control	[Million ops.]	13	13	13	13	13	13	10	10	12	12	6	6	6	6	6	6
Mechanical DC control	[Million ops.]	13	13	13	13	13	13	10	10	13	13	6	6	6	6	6	6
Electrical AC-3 (400 V)	[Million ops.]	1.3	1.3	1.3	1.3	1.3	1.3	—	—	1	0.8	1	1	1	—	—	1

Weight

AC	Non-Rev.	[kg (lbs)]	0.39 (0.86)	0.39 (0.86)	0.39 (0.86)	0.39 (0.86)	0.48 (1.06)	0.49 (1.08)	0.63 (1.39)	0.63 (1.39)	0.51 (1.12)	0.51 (1.12)	1.45 (3.20)	1.45 (3.20)	1.45 (3.20)	—	—	1.45 (3.20)
	Rev.	[kg (lbs)]	0.85 (1.89)	0.85 (1.89)	0.85 (1.89)	0.85 (1.89)	1.08 (2.39)	1.08 (2.39)	—	—	1.15 (2.54)	1.15 (2.54)	3.14 (6.92)	3.14 (6.92)	3.14 (6.92)	—	—	3.14 (6.92)
DC	Non-Rev.	[kg (lbs)]	0.6 (1.32)	—	—	—	—	—	—	—	—	—	1.47 (3.24)	1.47 (3.24)	1.47 (3.24)	—	—	1.47 (3.24)
	Rev.	[kg (lbs)]	1.27 (2.81)	—	—	—	—	—	—	—	—	—	3.22 (7.1)	3.22 (7.1)	3.22 (7.1)	—	—	3.22 (7.1)
DC (Electronic-EQ, EJ)	Non-Rev.	[kg (lbs)]	—	0.40 (0.88)	0.40 (0.88)	0.40(0.88)	0.40 (0.88)	0.49 (1.08)	0.49 (1.08)	0.57 (1.25)	0.57 (1.25)	0.57 (1.25)	0.57 (1.25)	—	—	—	—	—
	Rev.	[kg (lbs)]	—	0.87 (1.91)	0.87 (1.91)	0.87(1.91)	0.87 (1.91)	1.08 (2.39)	1.08 (2.39)	—	—	1.27 (2.79)	1.27 (2.79)	—	—	—	—	—
DC (Electronic- EW, EY, ED, EA)	Non-Rev.	[kg (lbs)]	—	0.43 (0.95)	0.43 (0.95)	0.43(0.95)	0.43 (0.95)	0.52 (1.14)	0.52 (1.14)	0.60 (1.32)	0.60 (1.32)	0.60 (1.32)	0.60 (1.32)	—	—	—	—	—
	Rev.	[kg (lbs)]	—	0.93 (2.05)	0.93 (2.05)	0.93(2.05)	0.93 (2.05)	1.14 (2.51)	1.14 (2.51)	—	—	1.33 (2.93)	1.33 (2.93)	—	—	—	—	—

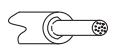
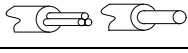
			100/104-C, 100S/104S-C													
			09	12	16	23	30	37	40	43	55	60	72	85	90	97
Coil Type:	Conventional		X	X	X	X	X	X	X	X	X	X	X	X	X	
	Electronic — EI		X	X	X	X	X	X	X	X	X	—	—	—	—	
Conductor Cross Sections - Main Contacts Terminal type			 (1)				 (2)		 (3)							
	1 conductor	[mm ²]	1...4				2.5...10		2.5...16		2.5...35					
	2 conductors	[mm ²]	1...4				2.5...10		2.5...10		2.5...25				2.5...35	
	1 conductor	[mm ²]	1.5...6				2.5...16		2.5...25		2.5...50					
	2 conductors	[mm ²]	1.5...6				2.5...16		2.5...16		2.5...35					
Recommended torque		[N•m]	1.5...2.0				2.5...3.5		2.5...3.5		4.5...6					
Cross section per UL/CSA		[AWG]	16...10				14...4		14...6	14...4		14...1				
Recommended torque		[lb-in]	13.3...17.7				22...31		22...31		40...53					

- (1) Pozidriv No. 2 / Blade No. 3 screw
- (2) Pozidriv No. 2 / Blade No. 4 screw
- (3) Hexagonal socket screw

Short-Circuit Coordination Data

See <http://www.rockwellautomation.com/global/support/global-sccr.page?> for complete short-circuit current ratings.



		100/104-C, 100S/104S-C															
		09	12	16	23	30	37	40*200	40*400	43	55	60	72	85	90*200	90*400	97
Coil Type:	Conventional	X	X	X	X	X	X	X	X	X	X	X	X	X	X	X	X
	Electronic - EI	X	X	X	X	X	X	X	X	X	X	—	—	—	—	—	—
Short Circuit Coordination (Max. Fuse or Circuit Breaker Rating) Per IEC 60947-4-1 (contactor and fuses only)																	
DIN Fuses- gG, gL		50 kA Available Fault Current															
Type"1"(690V)	[A]	50	50	50	80	125	125	160	160	160	160	250	250	250	250	250	250
Type"2"(400V)	[A]	25	35	35	40	80	80	63	80	100	100	160	160	160	160	100	200
Type"2"(690V)	[A]	25	35	35	40	80	80	63	80	100	100	160	160	160	160	100	200
BS88Fuses		65kA Available Fault Current															
Type"1"(415V)	[A]	25	32	40	50	63	80	—	—	80	TBD	100	160	160	—	—	TBD
Type"2"(415V)	[A]	20	25	32	50	63	80	—	—	80	TBD	100	125	160	—	—	TBD
Per UL 508 and CSA 22.2 No. 14 (contactor and fuses or circuit breaker only)																	
UL Class K5 and RK5 Fuses		5 kA Available Fault Current															
UL Listed Combination (600V)	[A]	35	40	70	90	110	125	125	125	150	200	200	—	—	—	—	—
UL Class K5 and RK5 Fuses		10 kA Available Fault Current															
UL Listed Combination (600V)	[A]	—	—	—	—	—	—	—	—	—	—	—	250	300	300	300	350
UL Class CC and CSA HRCI-MISC Fuses		100 kA Available Fault Current															
UL verified combination to IEC60947-4-1 "Type2"	[A]	20 ⁽¹⁾	20	30	40	—	—	—	—	—	—	—	—	—	—	—	—
UL Class J and CSA HRCI-J Fuses		100 kA Available Fault Current															
UL verified combination to IEC60947-4-1 "Type2"	[A]	20 ⁽¹⁾	20	30	40	50	50	—	—	70	TBD	80	100	150	—	—	175
UL Inverse-Time Circuit Breaker		5 kA Available Fault Current															
UL Listed Combination (480V)	[A]	30	30	50	50	125	125	—	—	125	150	250	—	—	—	—	—
UL Listed Combination (600V)	[A]	—	—	—	—	125	125	—	—	125	150	250	—	—	—	—	—
UL Inverse-Time Circuit Breaker		10 kA Available Fault Current															
UL Listed Combination (600V)	[A]	—	—	—	—	—	—	—	—	—	—	—	250	250	—	—	250
UL Inverse-Time Circuit Breaker		18 kA Available Fault Current															
UL Listed Combination (600V)	[A]	—	—	—	—	—	—	—	—	—	—	—	—	—	—	—	—
UL Inverse-Time Circuit Breaker		25 kA Available Fault Current															
UL Listed Combination (600Y/347V)	[A]	30 ⁽²⁾	30 ⁽²⁾	30 ⁽²⁾	30 ⁽²⁾	50 ⁽³⁾	50 ⁽³⁾	—	—	50 ⁽³⁾	—	110	110	110	—	—	—
UL Inverse-Time Circuit Breaker		25 kA Available Fault Current															
UL Listed Combination (600V)	[A]	—	—	—	—	100 ⁽⁴⁾	100 ⁽⁴⁾	—	—	100 ⁽⁴⁾	125	200 ⁽⁴⁾	225 ⁽⁴⁾	225 ⁽⁴⁾	—	—	225 ⁽⁴⁾
UL Inverse-Time Circuit Breaker		50 kA Available Fault Current															
UL Listed Combination (480V)	[A]	—	—	—	—	50 ⁽³⁾	50 ⁽³⁾	—	—	50 ⁽³⁾	—	—	—	—	—	—	—
UL Inverse-Time Circuit Breaker		65 kA Available Fault Current															
UL Listed Combination (480Y/277V)	[A]	30‡	30‡	30‡	30‡	—	—	—	—	—	—	—	—	—	—	—	—
UL Inverse-Time Circuit Breaker		65 kA Available Fault Current															
UL Listed Combination (480V)	[A]	—	—	—	—	100 ⁽⁴⁾	100 ⁽⁴⁾	—	—	100 ⁽⁴⁾	125	200 ⁽⁴⁾	225 ⁽⁴⁾	225 ⁽⁴⁾	—	—	225 ⁽⁴⁾

- (1) 15 A max. fuse for Type 2 coordination.
- (2) Ratings apply when used with Bulletin 140U-D circuit breakers only.
- (3) Minimum enclosure size 12-3/8 x 7-5/8 s 7-1/4 inches
- (4) Minimum enclosure size 20 x 12 x 8 inches with two latches.

Coil Data

			100/104-C, 100S/104S-C														
			09	12	16	23	30	37	40*200	40*400	43	55	60	72	85	90*200	90*400
Coil Type:	Conventional	X	X	X	X	X	X	X	X	X	X	X	X	X	X	X	X
	Electronic - EI	X	X	X	X	X	X	X	X	X	X	—	—	—	—	—	—
Operating Limits																	
50 Hz, 60 Hz, 50/60 Hz	pick-up	[$x U_s$]	0.85...1.1					0.85...1.1					0.85...1.1				
	dropout	[$x U_s$]	0.3...0.6					0.3...0.6					0.3...0.6				
DC (conventional)	pick-up	[$x U_s$]	—					—					0.8...1.1				
	dropout	[$x U_s$]	—					—					0.1...0.6				
DC (electronic—EQ, EJ, EW, QJ)	pick-up	[$x U_s$]	0.7...1.25					—					—				
	dropout	[$x U_s$]	0.3...0.4					—					—				
DC (electronic—EY)	pick-up	[$x U_s$]	0.8...1.25					—					—				
	dropout	[$x U_s$]	0.3...0.4					—					—				
DC (electronic—ED)	pick-up	[$x U_s$]	0.7...1.125					—					—				
	dropout	[$x U_s$]	0.3...0.4					—					—				
DC (electronic—EA)	pick-up	[$x U_s$]	0.8...1.1					—					—				
	dropout	[$x U_s$]	0.3...0.4					—					—				
Coil Consumption																	
50 Hz, 60 Hz, 50/60 Hz	pick-up	[VA]	75			105			135			235			400/240		
	hold-in	[VA/W]	9.5/2.7			12.3/3.1			13.3/3.3			19.6/5			24/9		
DC (conventional)	pick-up	[W]	—			—			—			200			325		
	hold-in	[W]	—			—			—			4			5		
DC (electronic—EQ, EJ, QJ)	pick-up (avg/peak)	[W]	10/17			16/25			—			—					
	hold-in	[W]	1.7			2.5			—			—					
DC (electronic—EY, EW)	pick-up (avg/peak)	[W]	10/17			16/25			—			—					
	hold-in	[W]	1.9			2.7			—			—					
DC (electronic—ED)	pick-up (avg/peak)	[W]	12/19			16/26			—			—					
	hold-in	[W]	2.1			2.8			—			—					
DC (electronic—EA)	pick-up (avg/peak)	[W]	14/22			18/29			—			—					
	hold-in	[W]	3.0			4.0			—			—					
Operating Times																	
AC	closing delay	[ms]	15...30	15...30	15...30	15...30			20...40			20...40					
	opening delay	[ms]	10...60	10...60	10...60	10...60			10...60			20...40					
With RC module	closing delay	[ms]	10...60	10...60	10...60	10...60		10...60	10...60			20...40					
DC (conventional)	opening delay	[ms]	—	—	—	—		50...80	20...40			15...25	20...25	20...25			
	closing delay	[ms]	—	—	—	—		7...15	—			—					
With integrated diode	opening delay	[ms]	—	—	—	—		17...23	≤ 220V 20...35			≤ 220V 20...35					
With external diode	opening delay	[ms]	—	—	—	—	—	80...125	—			—					
DC (electronic—EQ, EJ)	closing delay	[ms]	20...50					—			—						
	opening delay	[ms]	20...50					—			—						
	Max. Ripple		±15%					—			—						
	min. OFF time	[ms]	50					—			—						
DC (electronic—EW, EY, ED, EA)	closing delay	[ms]	20...50					—			—						
	opening delay	[ms]	23...33					—			—						
	Max. Ripple		±15%					—			—						
	min. OFF time	[ms]	50					—			—						
DC (electronic—QJ)	closing delay	[ms]	20...50					—			—						
	opening delay	[ms]	16...21					—			—						
	Max. Ripple		±15%					—			—						
	min. OFF time	[ms]	50					—			—						

Auxiliary Contacts, Auxiliary Contact Blocks, and Pneumatic Timers

			Internal	Front mounted	Front mounted (Bifurcated)	Side-mounted
Switching of AC Loads						
AC-12 I_{th}	at 40 °C	[A]	20	10	10	10
	at 60 °C	[A]	20	6	6	6
AC-15 at rated voltage of	24V	[A]	10	6	3	6
	42/48V	[A]	10	6	3	6
	120V	[A]	10	6	3	6
	230V	[A]	10	5.5	3	5.5
	240V	[A]	10	5	3	5
	400V	[A]	6	3	2	3
	415V	[A]	6	3	2	3
	500V	[A]	2.5	1.6	1.2	1.6
690V	[A]	1	1	0.7	1	
Switching of DC Loads						
DC-12 L/R < 1 ms resistive loads at	24V DC	[A]	12	12	6	6
	48V DC	[A]	9	9	3.2	3.2
	110V DC	[A]	3.5	3.5	1	1
	220V DC	[A]	0.55	0.55	0.5	0.5
	440V DC	[A]	0.2	0.2	0.2	0.2
DC-14L/R <15 ms inductive loads with economy resistor in series at	24V DC	[A]	9	9	2	2
	48V DC	[A]	5	5	1.6	1.6
	110V DC	[A]	2	2	0.3	0.3
	220V DC	[A]	0.4	0.4	0.12	0.12
DC-13 switching electromagnets at	440V DC	[A]	0.16	0.16	0.05	0.05
	24V DC	[A]	5	5	2.5	5
	48V DC	[A]	3	3	1.5	2.5
	110V DC	[A]	1.2	1.2	0.6	0.68
	220V DC	[A]	0.6	0.6	0.3	0.32
440V DC	[A]	0.3	0.15	0.15	0.15	
Fuse gG						
		[A]	20	10	10	10
		[A]	20	10	10	10
Protective Separation per IEC 60947-1, Annex N			between load and auxiliary circuit 320V	between load and auxiliary circuit 440V		
Min. switching capacity according to IEC 60947-5-4			17V/10mA	17V/5mA	5V/3mA	17V/10mA
Load Carrying Capacity per UL/CSA						
Rated voltage	AC	[V]	max.600			
Continuous rating	40 °C	[A]	10	10	10	10
Switching capacity	AC	[A]	A600			
Rated voltage	DC	[V]	max.600			
Switching capacity	DC	[A]	P600	Q600	Q600	

General

Rated Isolation Voltage U_i		
IEC	[V]	690
UL, CSA	[V]	600
Rated Impulse Voltage Withstand U_{imp}	[kV]	6
Rated Voltage U_e		
AC 50/60 Hz	[V]	115, 200, 230, 240, 400, 415, 460, 500, 575, 690
DC	[V]	24, 48, 110, 220, 440
Insulation Class of the Coil		Class F per IEC 60085
Rated coil frequency		AC50/60Hz, DC
Ambient Temperature		
Storage	[°C]	-55...+80
Operation at rated voltage	[°C]	-25...+60
at 70 °C		15% current reduction against 60 °C values
Climatic Withstand		IEC 60068-2-1/-2/-30
Max. Altitude of Installation Site	[m]	2000 NN, per IEC60947-1
Protection Class		100-C09...C23: IP2X from all directions 100-C30...C55: IP2X from front with front (upper) terminal wired 100-C60...C97: IP2X from front with front (upper) terminal wired (min. wire size 16 mm ² or #6 AWG)
Single contactor cover		—
Contactor with frame terminal block		—
Auxiliary contact		IP2X
Protection against Accidental Contact		Finger- and back-of-hand proof per VDE0106, part100
Resistance to Shock		IEC60068-2-27
Resistance to Vibration		IEC60068-2-6
Mechanically Linked Contacts IEC60947-5-1, Annex L		100-/100S-C09...C55+100-FA/-FB/-FC, (except L11, L22), 100-/100S-C09...C55+100-FAB/-FBB/-FCB
Mirror Contacts IEC60947-4 Annex F		100-/100S-C09...C97+100-FA/-FB/-FC, (except L11, L22), 100-/100S-C09...C97+100-SA/SB, 100-/100S-C09...C97+100-FAB/-FBB/-FCB

Standards Compliance and Certifications

100-C IEC Contactors

Standards Compliance	Certifications
EN/IEC 60947-4-1, 60947-5-1	CE Marked
IEC 60947 Type "2" Coordination	CCC
CSA 22.2. No. 14	cULus Listed (File No. E3125; Guide NLDX, NLDX7)
UL 508	
Meets the material restrictions for European Directive 2002/95/EC-EU-RoHS	

100S-C IEC Safety Contactors

Standards Compliance	Certifications
EN50205	CE Marked
CSA C22.2 No. 14	SUVA Third-Party Certified
UL 508	cULus Listed (File No. E3125; Guide NLDX, NLDX7)
EN/IEC 60947-4	
IEC 60947-4-1 Annex F — Mirror Contacts	
IEC 60947-5-1 Annex L — Mechanically Linked Contacts	
Meets the material restrictions for European Directive 2002/95/EC-EU-RoHS	

100Q-C Capacitor-switching Contactors

Standards Compliance	Certifications
IEC 60947-4	CE Marked
CSA C22.2 No. 14	cULus Listed (File No. E 41850, Guide NLDX, NLDX7)
UL 508	
Meets the material restrictions for European Directive 2002/95/IEC-EU-RoHS	

Life-Load Curves

Bulletin 100-C/104-C IEC contactors are designed for superior performance in a wide variety of applications. When selecting IEC products, the user must give consideration to the specific load, utilization category, and required electrical life of the application. The life-load curves shown here are based on Rockwell Automation tests according to the requirements defined in IEC 60947-4-1. Since contact life in application is dependent on environmental conditions and duty cycle, actual application contact life may vary from that indicated by the curves shown here.

To find the contactor's estimated electrical life, follow these guidelines:

1. Identify the appropriate utilization category from [Table 1](#).
2. Choose the graph for the utilization category selected.
3. Locate the intersection of the life-load curve for the appropriate contactor with the application's operational current (I_e) found on the horizontal axis.
4. Read the estimated contact life along the vertical axis.

Contact Life for Mixed Utilization Categories AC-3 and AC-4:

In many applications, the utilization category cannot be defined as either purely AC-3 or AC-4. In those applications, the electrical life of the contactor can be estimated from the following equation:

$$L_{\text{mixed}} = L_{\text{ac3}} / [1 + P_{\text{ac4}} * (L_{\text{ac3}} / L_{\text{ac4}} - 1)], \text{ where:}$$

L_{mixed} = Approximate contact life in operations for a mixed AC-3/AC-4 utilization category application

L_{ac3} = Approximate contact life in operations for a pure AC-3 utilization category (from the AC-3 life-load curves)

L_{ac4} = Approximate contact life in operations for a pure AC-4 utilization category (from the AC-4 life-load curves)

P_{ac4} = Percentage of AC-4 operations

Table 1 - Utilization Category Determination

Test Conditions		Making			Breaking		
		I/I_e	U/U_e	$\cos \phi$	I_c/I_e	U_r/U_e	$\cos \phi$
AC-1	Resistance Furnaces: Non inductive or slightly inductive loads	1	1	0.95	1	1	0.95
AC-2	Slip-ring motors: Starting and reversing	2.5	1	0.65	2.5	1	0.65
AC-3	Squirrel-cage motors: Starting and stopping of running motors	$I_e < 17\text{ A}$	6	1	0.65	1	0.17
		$I_e > 17\text{ A}$	6	1	0.35	1	0.17
AC-4	Squirrel-cage motors: Starting, plugging ⁽¹⁾ , inching ⁽²⁾	$I_e < 17\text{ A}$	6	1	0.65	6	1
		$I_e > 17\text{ A}$	6	1	0.35	6	1
AC-15	Solenoids: Contactors, valves and lifting magnets	10	1	0.7	1	1	0.4

- (1) Plugging is understood as stopping or reversing the motor rapidly by reversing motor primary connections while the motor is running.
- (2) Inching (jogging) is understood as energizing a motor once or repeatedly for short periods to obtain small movements of the driven mechanism.

I_e Rated operational current
 I Making Current
 I_c Breaking Current
 U Off-load voltage
 U_e Rated voltage
 U_r Recovery voltage

Figure 5 - AC-1, 40 °C Non- or slightly inductive loads, resistance furnaces; $U_e = 230...690\text{V}$

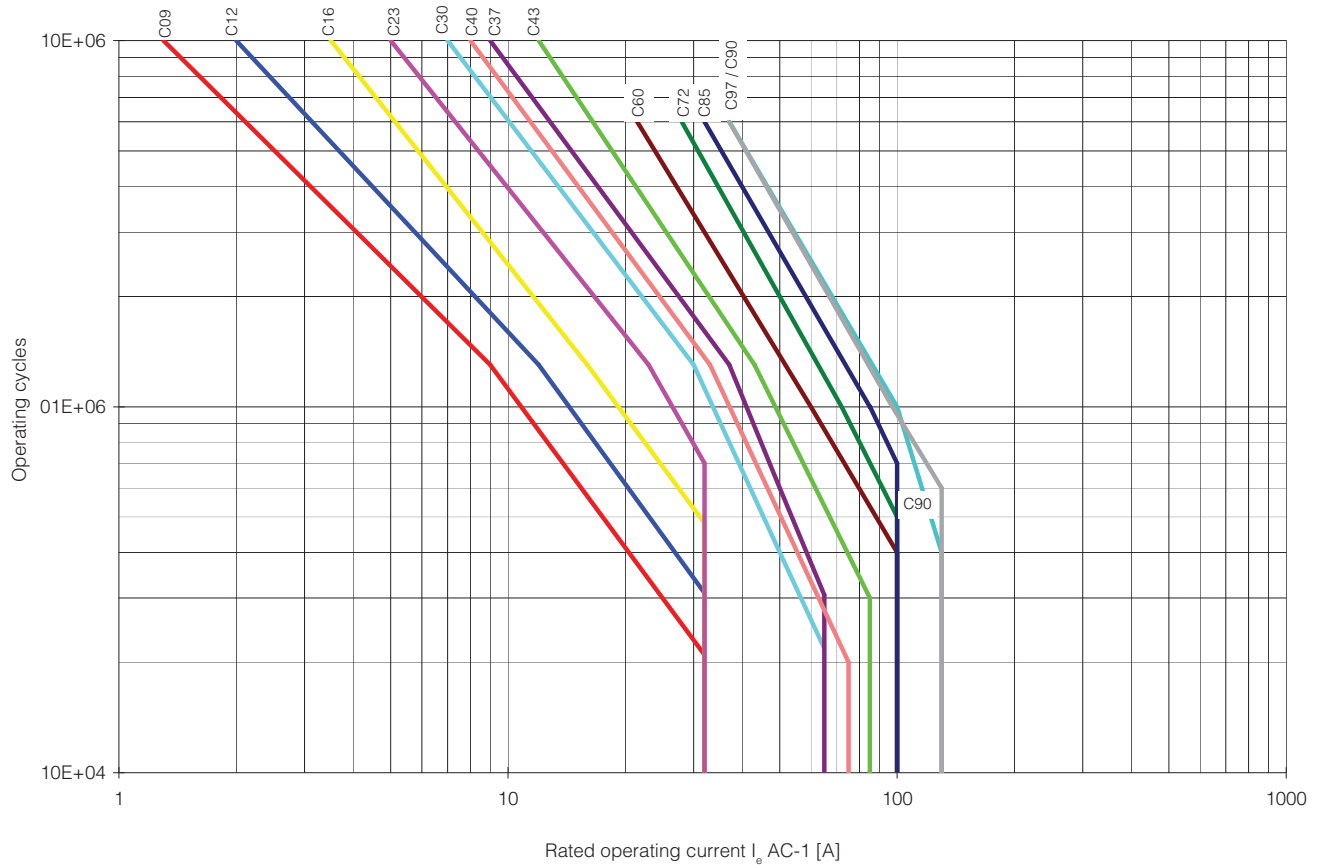

Figure 6 - AC-2, Switching of slip-ring motors; $U_e = 230...400...460V$

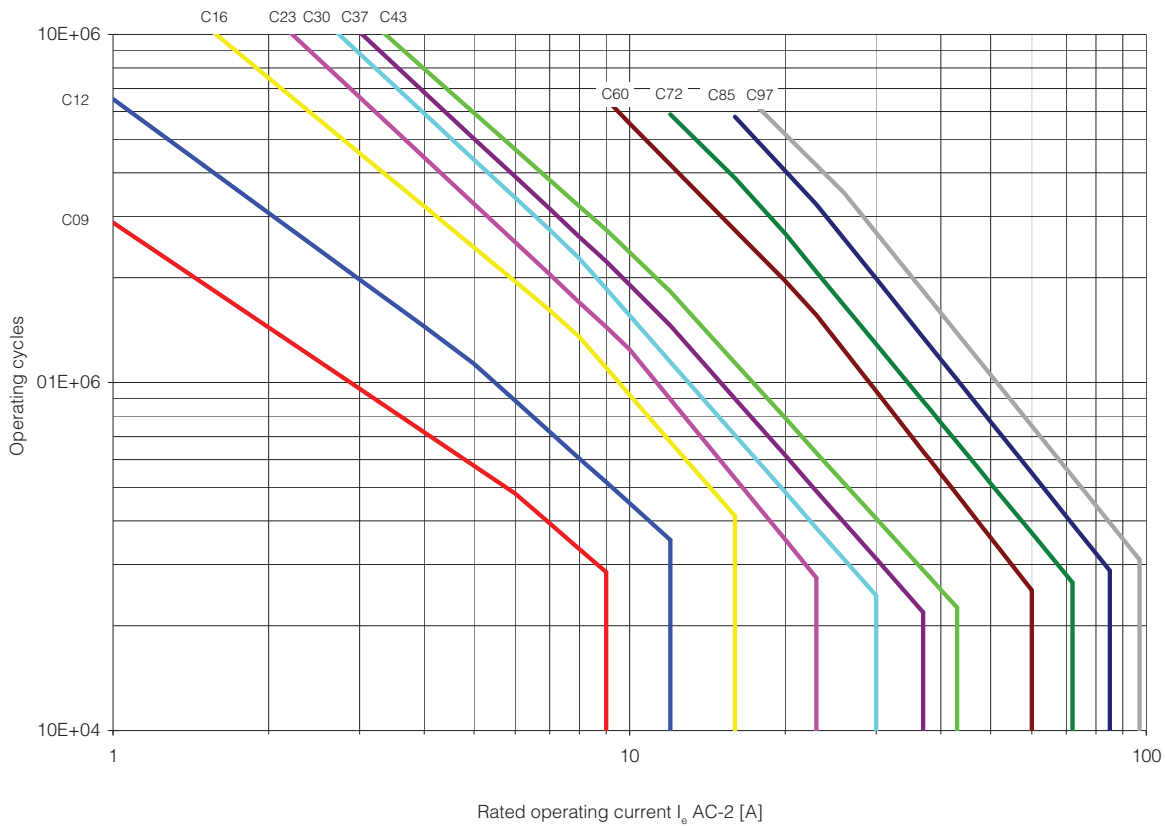

Figure 7 - AC-3, Switching of squirrel-cage motors while starting; $U_e = 230...400...460V$

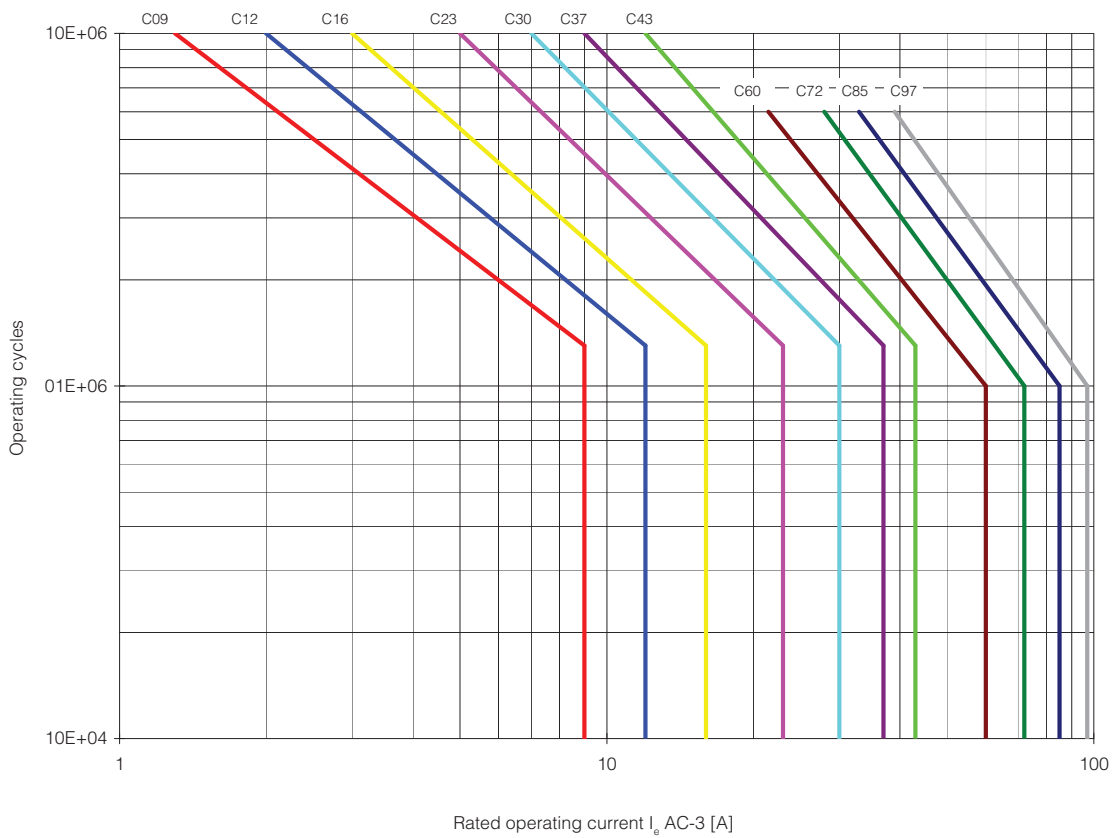

Figure 8 - AC-3, Switching of squirrel-cage motors while starting; $U_e = 500...575V$

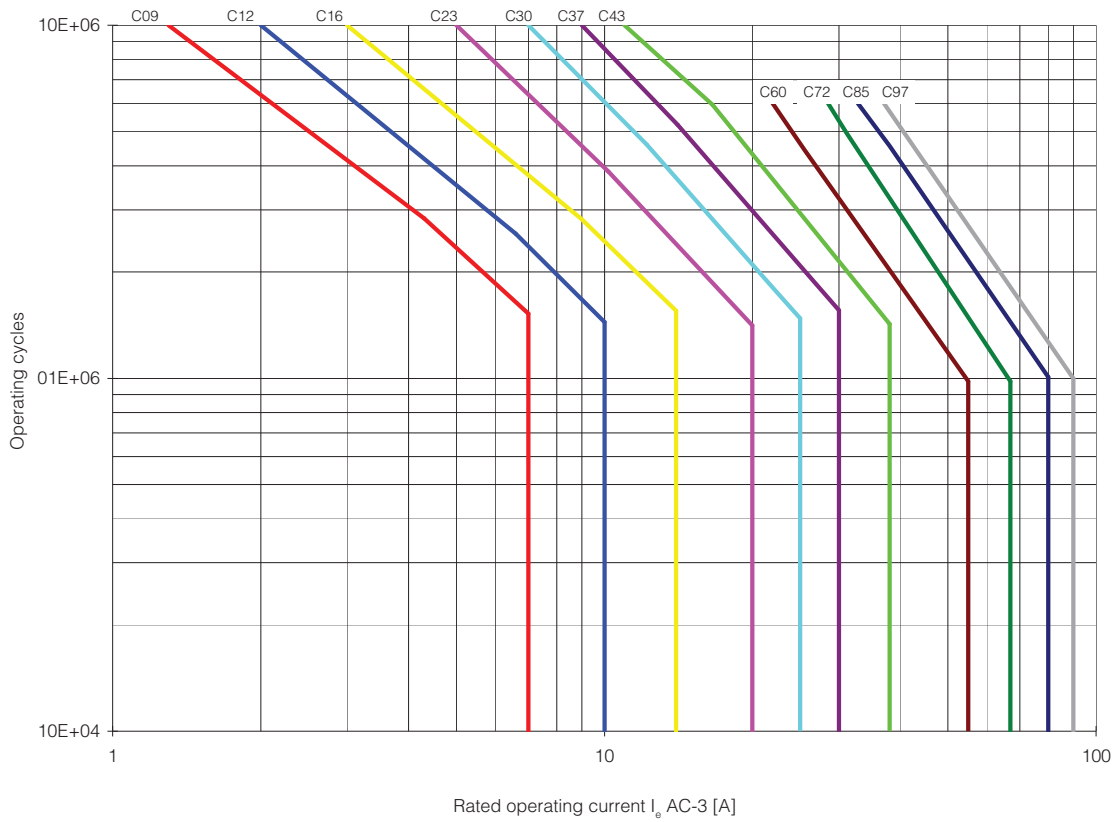

Figure 9 - AC-3, Switching of squirrel-cage motors while starting; $U_e = 690V$

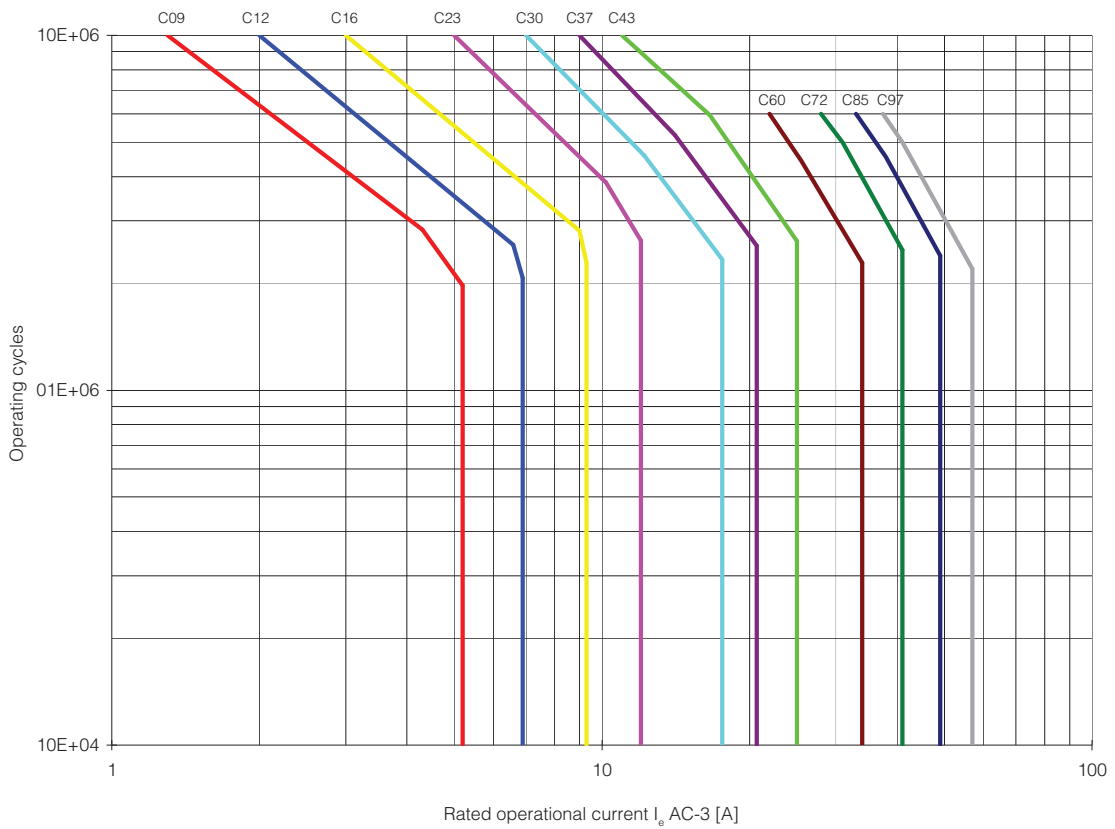

Figure 10 - AC-4, Switching of squirrel-cage motors; $U_e = 230...690V$

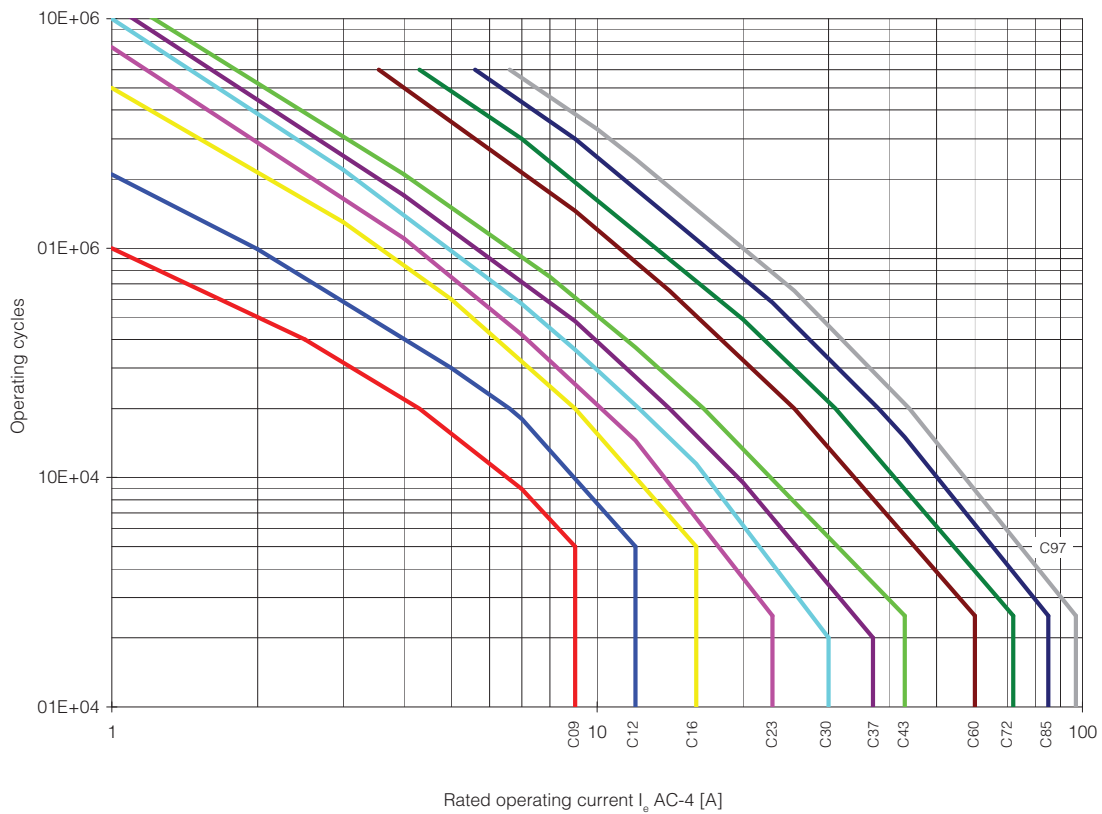

Figure 11 - AC-3 & AC-4, 10% AC-4 Mixed operation of squirrel-cage motors; $U_e = 230...400...460V$

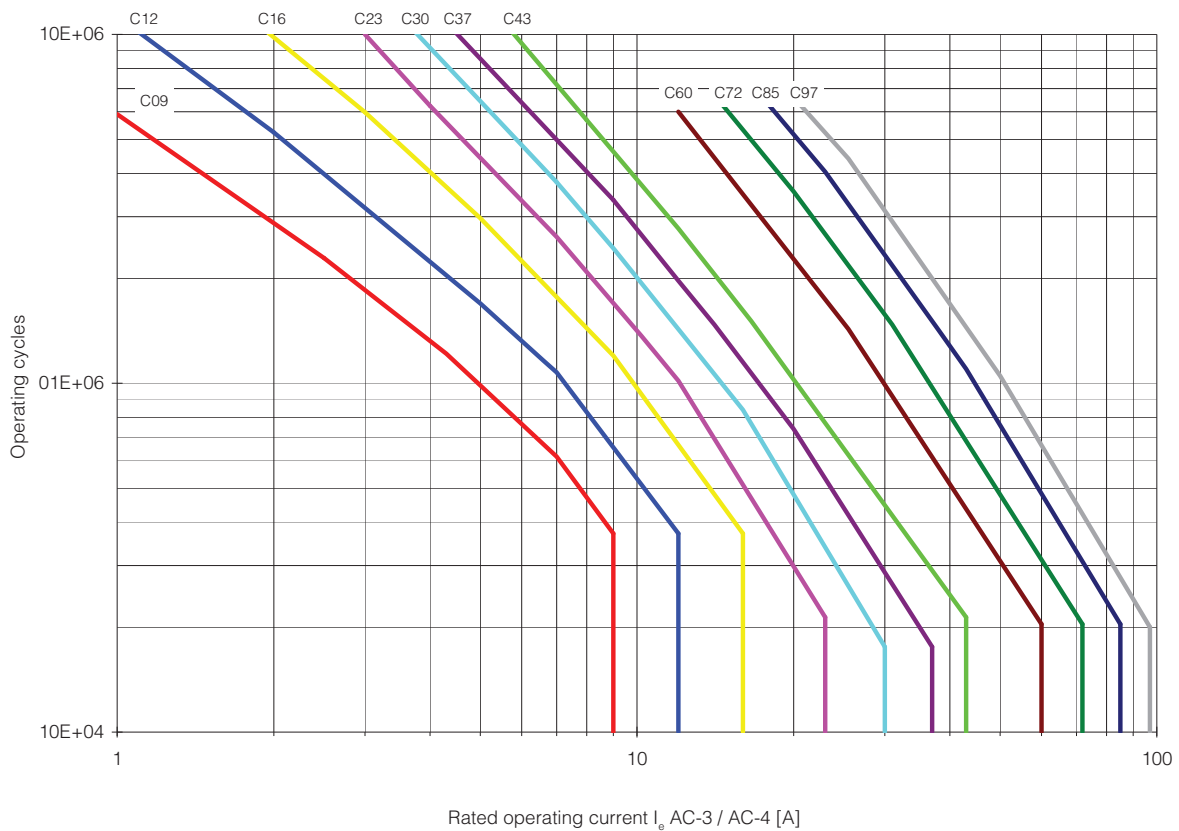
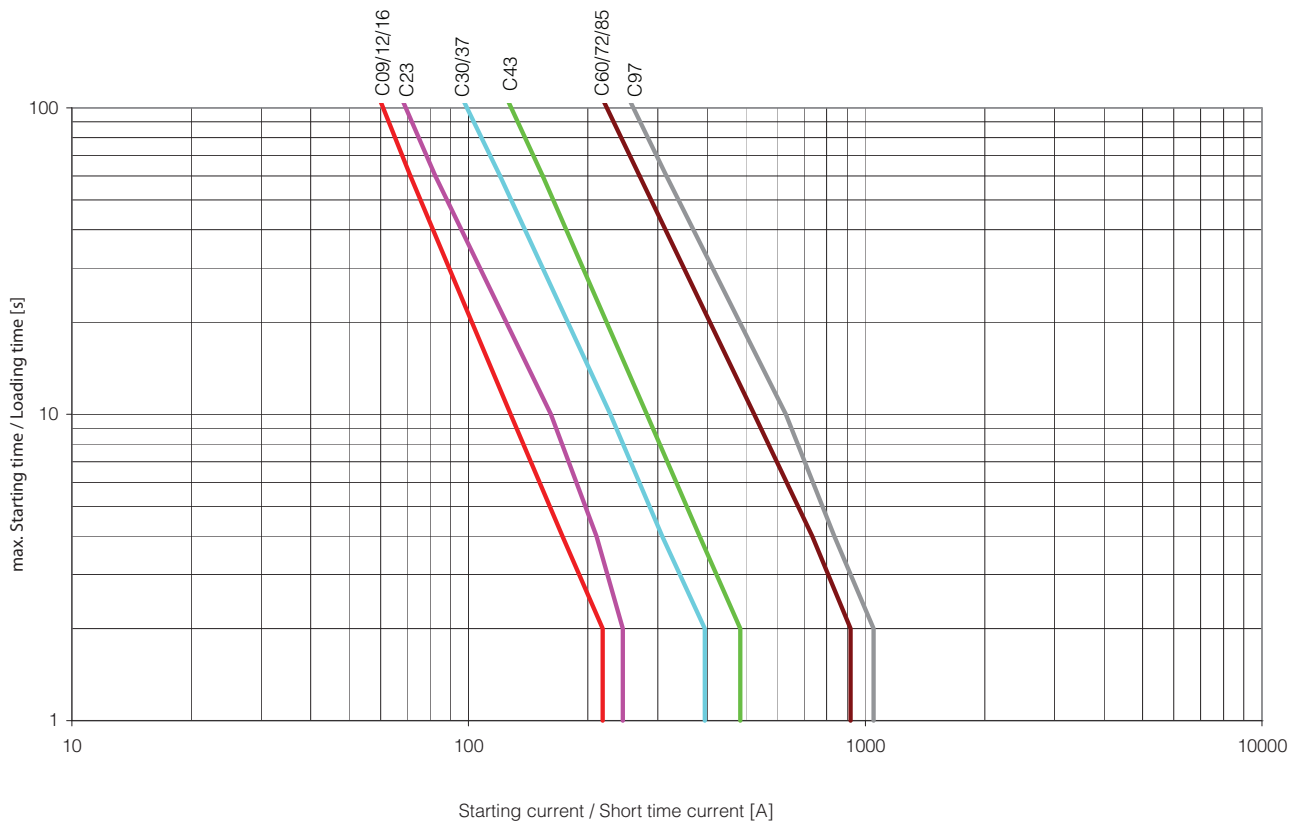

Figure 12 - Heavy Duty Starting and Regular Short-time Operation



Maximum Operating Rates

Figure 13 - AC-1, 40 °C Non- or slightly inductive loads, resistance furnaces; $U_e = 230 \dots 690V$

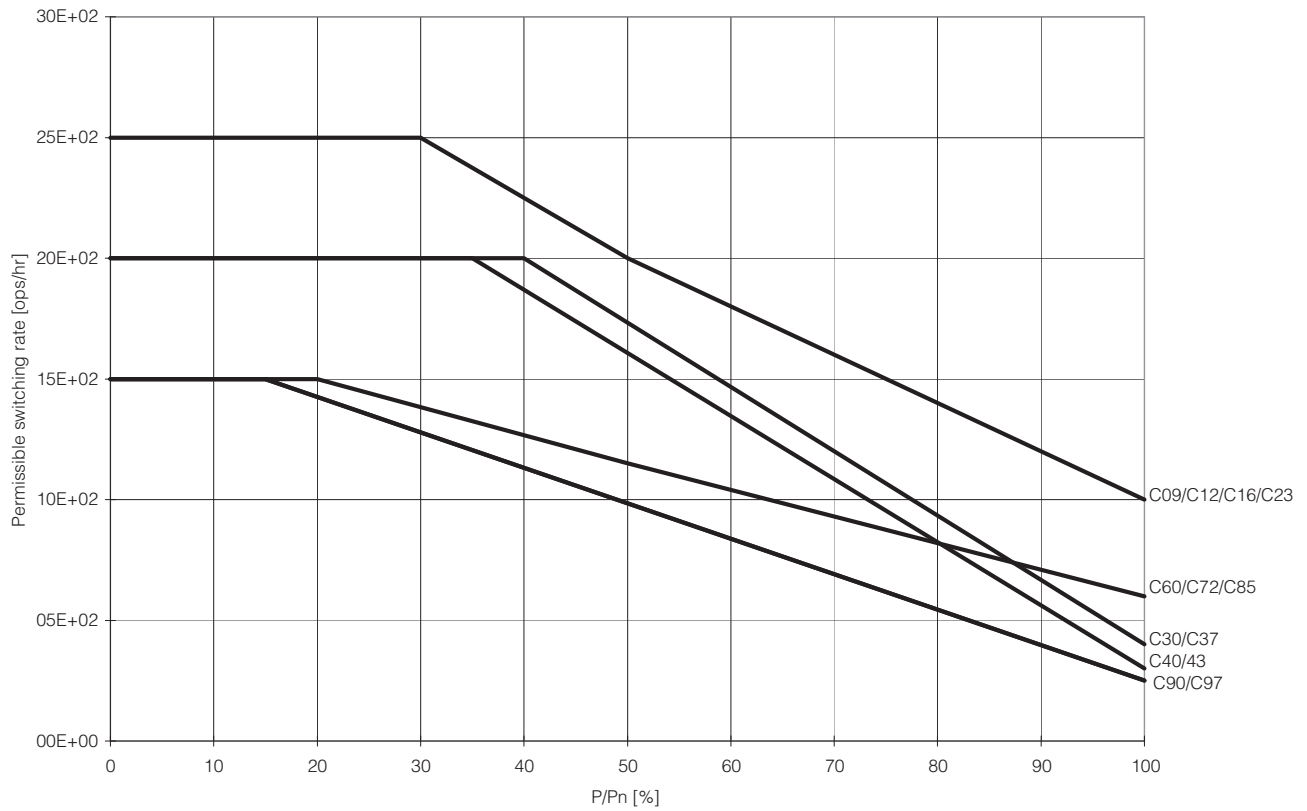

Figure 14 - AC-2, Stepping of slip-ring motors; $U_e = 230...460V$

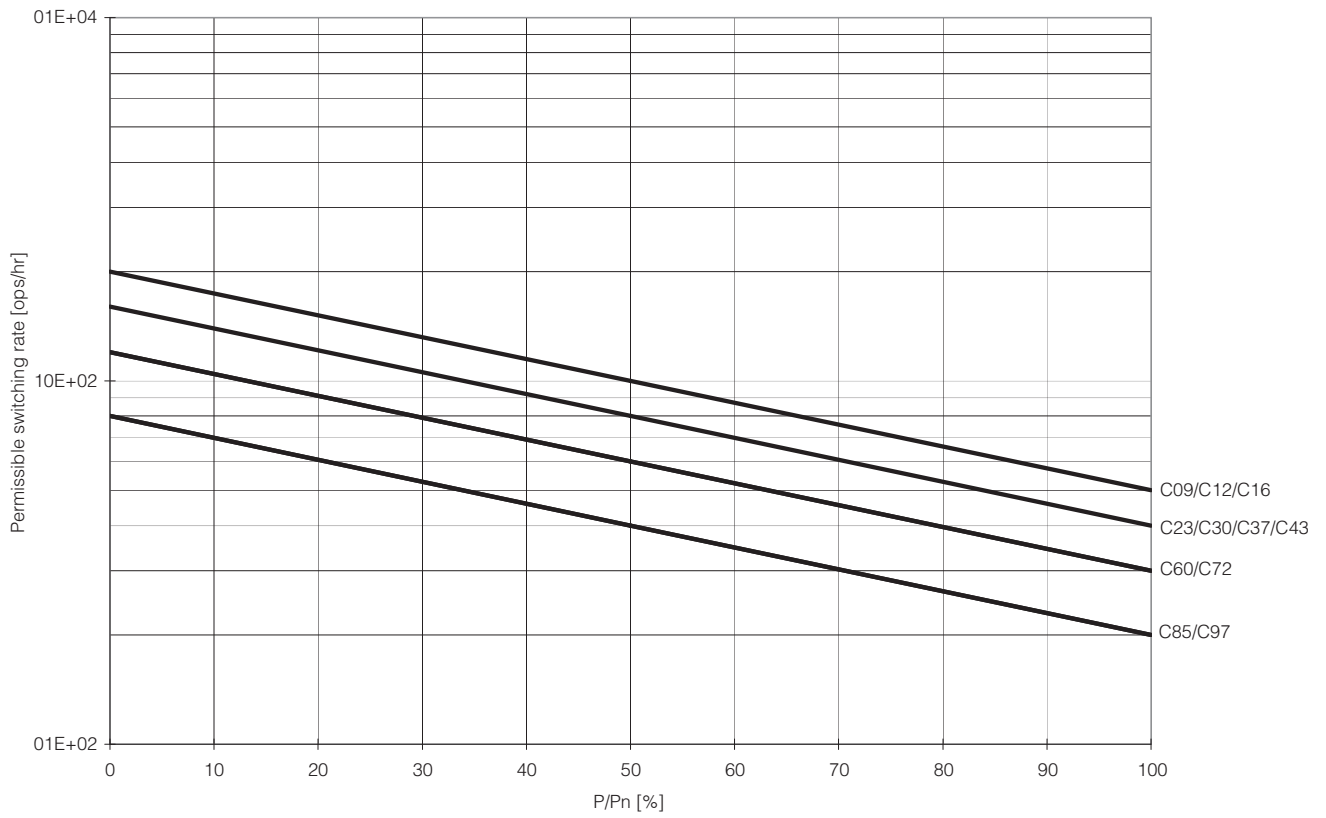

Figure 15 - AC-3, Switching of squirrel-cage motors while starting; $U_e = 230...460V$; Relative operating time 40%, Starting time $t_A = 0.25 s$

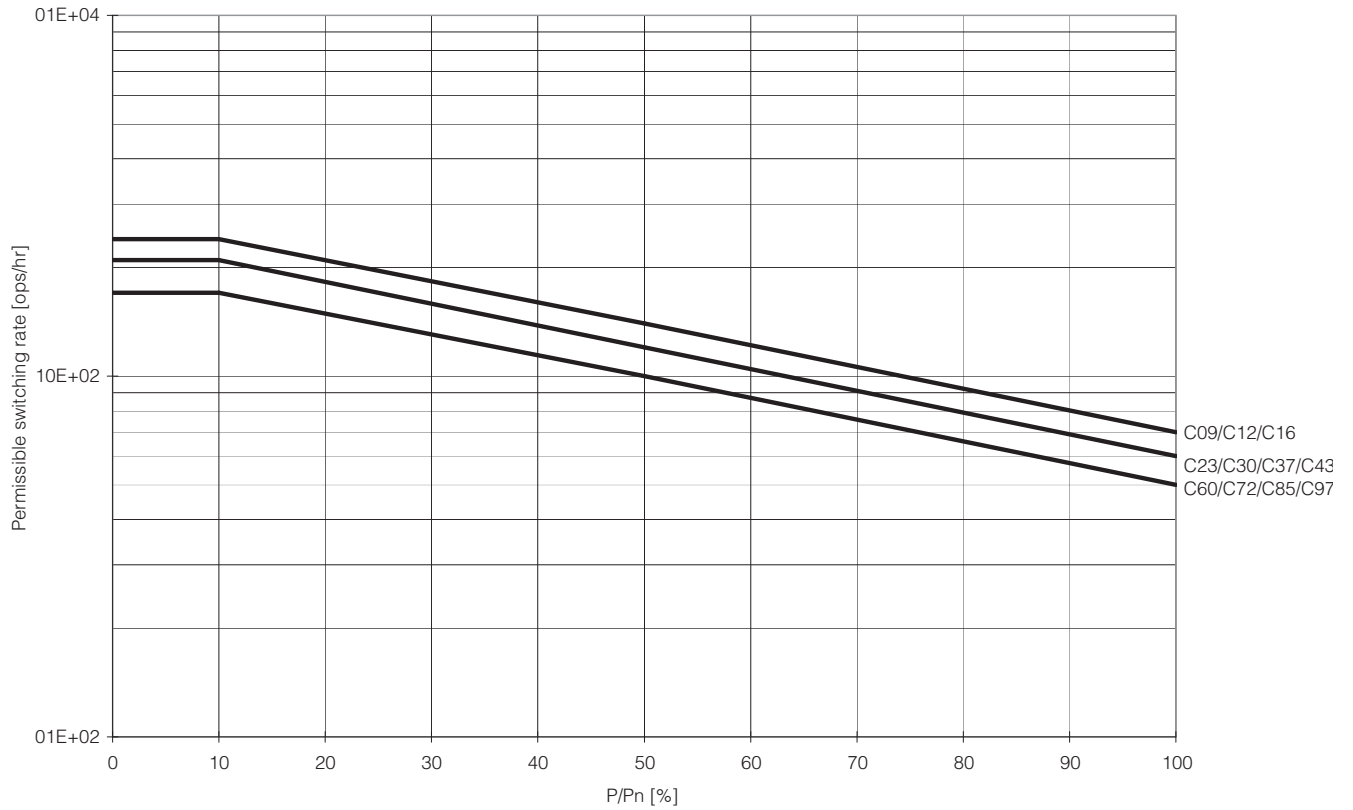
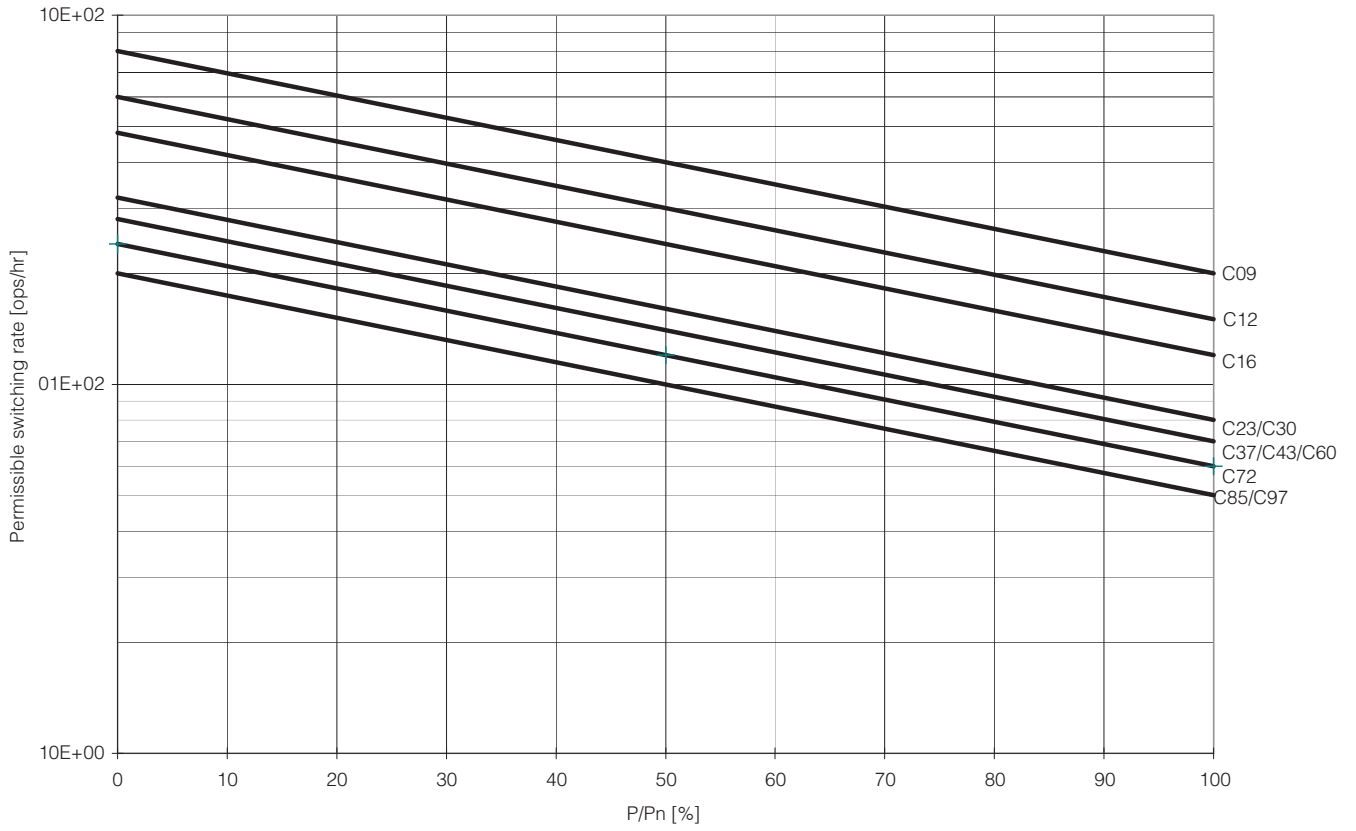

Figure 16 - AC-4, Inching of squirrel-cage motors; $U_e = 230 \dots 460V$, Starting time $t_A = 0.25 s$



Approximate Dimensions

Dimensions are shown in millimeters (inches). Dimensions are not intended for manufacturing purposes.

Bulletin 100-C/104-C, 100S-C/104S-C Approximate Dimensions

Figure 17 - Bulletin 100-C/100S-C Contactors and Accessories

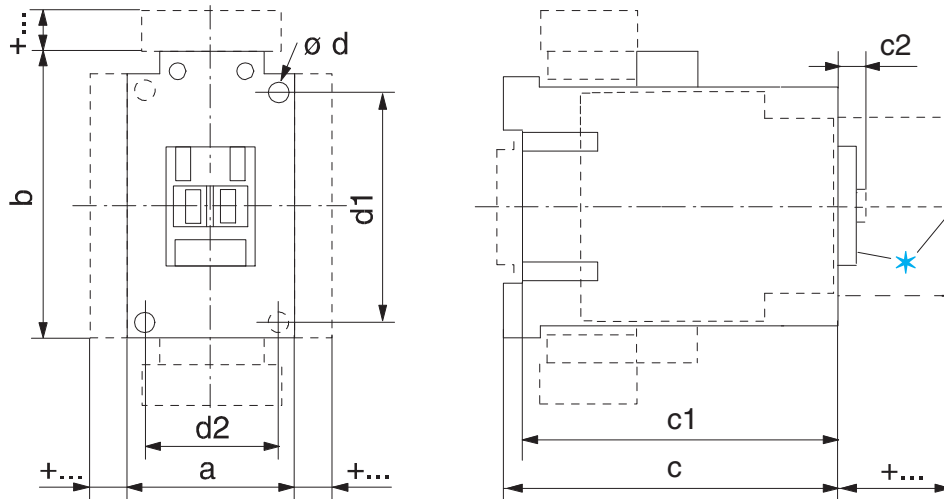

Figure 18 - Mounting Position — 100-C Contactors; 100S-C AC Contactors and DC contactors with electronic coils

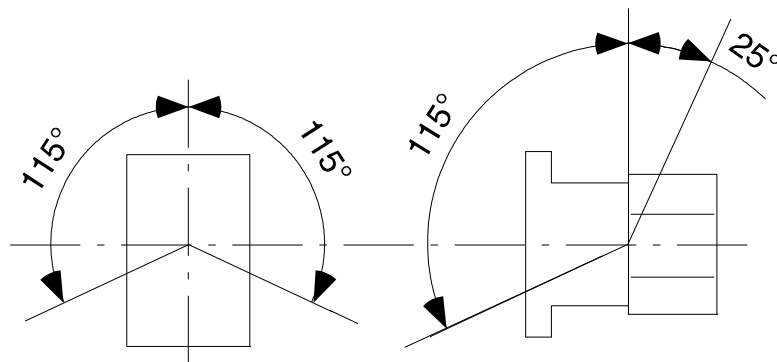

Figure 19 - Mounting Position — 100S-C DC contactors

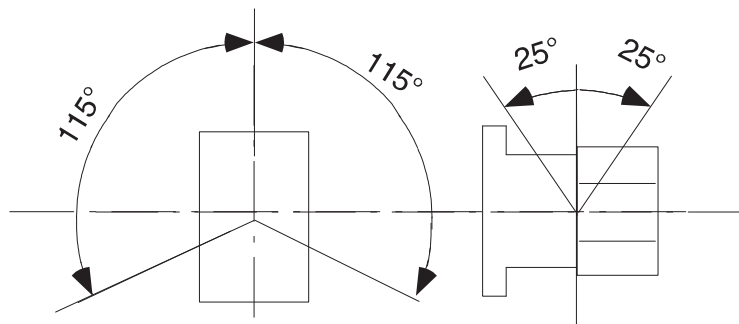

Table 2 - AC Contactors and DC Contactors with 12V or 24V Electronic Coils

Cat. No.	a	b	c	c1	c2	Ø d	d1	d2
100-C09...100-C23	45 (1-25/32)	81 (3-3/16)	80.5 (3-11/64)	75.5 (2-31/32)	6 (15/64)	2 - 4.5 (2 -3/16)	60 (2-23/64)	35 (1-3/8)
100-C30, 100-C37	45 (1-25/32)	81 (3-3/16)	97.5 (4)	92.5 (3-41/64)	6.5 (1/4)	2 - 4.5 (2 -3/16)	60 (2-23/64)	35 (1-3/8)
100-C40	59 (2-21/64)	81 (3-3/16)	100.5 (3-61/64)	95.5 (3-49/64)	6.5 (1/4)	2 - 4.5 (2 -3/16)	60 (2-23/64)	45 (1-25/32)
100-C43, 100-C55	54 (2-1/8)	81 (3-3/16)	100.5 (3-61/64)	95.5 (3-49/64)	6.5 (1/4)	2 - 4.5 (2 -3/16)	60 (2-23/64)	45 (1-25/32)
100-C60...100-C97	72 (2-53/64)	122 (4-51/64)	117 (4-39/64)	111.5 (4-25/64)	8.5 (21/64)	4 - 5.4 (4 - 7/32)	100 (3-15/16)	55 (2-11/64)
100-C90	95 (3-47/64)	122 (4-51/64)	117 (4-39/64)	111.5 (4-25/64)	8.5 (21/64)	4 - 5.4 (4 - 7/32)	100 (3-15/16)	55 (2-11/64)
100S-C09...100S-C23	45 (1-25/32)	81 (3-3/16)	119.5 (4-3/4)	114.5 (4-43/64)	6 (15/64)	2 - 4.5 (2 -3/16)	60 (2-23/64)	35 (1-3/8)
100S-C30, 100S-C37	45 (1-25/32)	81 (3-3/16)	136.5 (5-37/64)	131.6 (5-11/32)	6.5 (1/4)	2 - 4.5 (2 -3/16)	60 (2-23/64)	35 (1-3/8)
100S-C43, 100S-C55	54 (2-1/8)	81 (3-3/16)	139.5 (5-11/16)	134.6 (5-29/64)	6.5 (1/4)	2 - 4.5 (2 -3/16)	60 (2-23/64)	45 (1-25/32)
100S-C60...100S-C97	72 (2-53/64)	122 (4-51/64)	156 (6-11/32)	150.5 (6-1/8)	8.5 (21/64)	4 - 5.4 (4 - 7/32)	100 (3-15/16)	55 (2-11/64)

Table 3 - DC Contactors with Conventional Coils

Cat. No.	a	b	c	c1	c2	Ø d	d1	d2
100-C60D...100-C97D	72 (2-53/64)	122 (4-51/64)	117 (4-39/64)	111.5 (4-25/64)	8.5 (21/64)	4 - 5.4 (4 - 7/32)	100 (3-15/16)	55 (2-11/64)
100-C90D	95 (3-47/64)	81 (3-3/16)	117 (4-39/64)	111.5 (4-25/64)	8.5 (21/64)	4 - 5.4 (4 - 7/32)	100 (3-15/16)	55 (2-11/64)
100S-C09Z...100S-C16Z	45 (1-25/32)	81 (3-3/16)	145.5 (5-49/64)	140.5 (5-37/64)	6 (15/64)	2 - 4.5 (2 -3/16)	60 (2-23/64)	35 (1-3/8)
100S-C23Z	45 (1-25/32)	81 (3-3/16)	162.5 (6-7/16)	158 (6-1/4)	6 (15/64)	2 - 4.5 (2 -3/16)	60 (2-23/64)	35 (1-3/8)
100S-C30Z...100S-C37Z	45 (1-25/32)	81 (3-3/16)	180.5 (7-5/32)	175.5 (6-61/64)	6.5 (1/4)	2 - 4.5 (2 -3/16)	60 (2-23/64)	35 (1-3/8)
100S-C43Z	54 (2-1/8)	81 (3-3/16)	183.5 (7-17/64)	179 (7-3/32)	6.5 (1/4)	2 - 4.5 (2 -3/16)	60 (2-23/64)	45 (1-25/32)
100S-C60D...100S-C97D	72 (2-53/64)	122 (4-51/64)	156 (6-11/32)	150.5 (6-1/8)	8.5 (21/64)	4 - 5.4 (4 - 7/32)	100 (3-15/16)	55 (2-11/64)

Table 4 - DC Contactors with 36...48V, 48...72V, 110...125V, or 200...250V DC Electronic Coils

Cat. No.	a	b	c	c1	c2	Ø d	d1	d2
100-C09E...100-C23E	45 (1-25/32)	105 (4-1/8)	80.5 (3-11/64)	75.5 (2-31/32)	6 (15/64)	2 - 4.5 (2 -3/16)	60 (2-23/64)	35 (1-3/8)
100-C30E...100-C37E	45 (1-25/32)	105 (4-1/8)	97.5 (4)	92.5 (3-41/64)	6.5 (1/4)	2 - 4.5 (2 -3/16)	60 (2-23/64)	35 (1-3/8)
100-C40E	59 (2-21/64)	105 (4-1/8)	100.5 (3-61/64)	95.5 (3-49/64)	6.5 (1/4)	2 - 4.5 (2 -3/16)	60 (2-23/64)	45 (1-25/32)
100-C43E...100-C55E	54 (2-1/8)	105 (4-1/8)	100.5 (3-61/64)	95.5 (3-49/64)	6.5 (1/4)	2 - 4.5 (2 -3/16)	60 (2-23/64)	45 (1-25/32)
100S-C09E...100S-C23E	45 (1-25/32)	105 (4-1/8)	119.5 (4-3/4)	114.5 (4-43/64)	6 (15/64)	2 - 4.5 (2 -3/16)	60 (2-23/64)	35 (1-3/8)
100S-C30E...100S-C37E	45 (1-25/32)	105 (4-1/8)	136.5 (5-37/64)	131.6 (5-11/32)	6.5 (1/4)	2 - 4.5 (2 -3/16)	60 (2-23/64)	35 (1-3/8)
100S-C43E...100S-C55E	54 (2-1/8)	105 (4-1/8)	139.5 (5-11/16)	134.6 (5-29/64)	6.5 (1/4)	2 - 4.5 (2 -3/16)	60 (2-23/64)	45 (1-25/32)

Table 5 - 100-C/104-C Accessories

Contactors with		mm	(inches)
Auxiliary contact block for front mounting	2- or 4-pole	$c/c1 + 39$	$(c/c1 + 1-37/64)$
Auxiliary contact block for side mounting	1- or 2-pole	$a + 9$	$(a + 23/64)$
Pneumatic Timing Module		$c/c1 + 58$	$(c/c1 + 2-23/64)$
Electronic Timing Module	on coil terminal side	$b + 24$	$(b + 15/16)$
Mechanical Interlock	on side of contactor	$a + 9$	$(a + 23/64)$
Mechanical Latch		$c/c1 + 61$	$(c/c1 + 2-31/64)$
Interface Module	on coil terminal side	$b + 9$	$(b + 23/64)$
Surge Suppressor	on coil terminal side	$b + 3$	$(b + 1/8)$
Labeling with ?	label sheet	+ 0	(+ 0)
	marking tag sheet with clear cover	+ 0	(+ 0)
	marking tag adapter for System V4 / V5	+ 5.5	(+ 7/32)
	marking tag adapter for System Bul. 1492W	+ 5.5	(+ 7/32)
Terminal Lug Kit	100-C09...C23	$b + 53$	$(b + 2-3/32)$
	100-C30...C37	$b + 44$	$(b + 1-47/64)$
	100-C43...C55	$b + 52$	$(b + 2-3/64)$
	100-C60...C97	$b + 99$	$(b + 3-7/8)$
Paralleling Links	100-C09...C23	$b + 78$	$(b + 3-1/16)$
		$c + 9/5$	$(c + 3/8)$
	100-C30...C37	$b + 85$	$(b + 3-11/32)$

Table 6 - 100S-C/104S-C Accessories

Contactors with		mm	(inches)
Auxiliary contact block for side mounting	1- or 2-pole	$a + 9$	$(a + 23/64)$
Electronic Timing Module	on coil terminal side	$b + 24$	$(b + 15/16)$
Mechanical Interlock	on side of contactor	$a + 9$	$(a + 23/64)$
Interface Module	on coil terminal side	$b + 9$	$(b + 23/64)$
Surge Suppressor	on coil terminal side	$b + 3$	$(b + 1/8)$
Labeling with	label sheet	+ 0	(+ 0)
	marking tag sheet with clear cover	+ 0	(+ 0)
	marking tag adapter for System V4 / V5	+ 5.5	(+ 7/32)
	marking tag adapter for System Bul. 1492W	+ 5.5	(+ 7/32)

Bulletin 100Q-C Approximate Dimensions

Figure 20 - Bulletin 100Q- Contactors

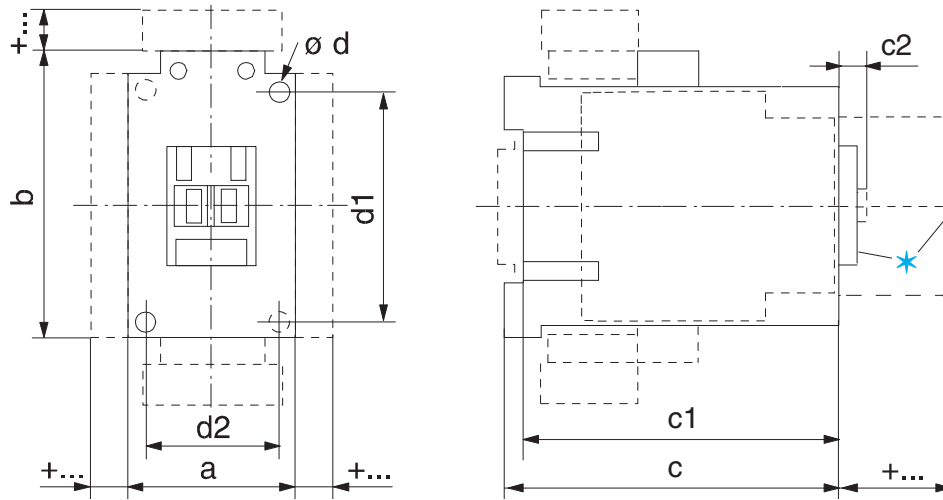

Table 7 - AC Contactors and DC Contactors with 12V or 24V Electronic Coils

Cat. No.	a	b	c	c1	c2	Ø d	d1	d2
100Q-C16	45 (1-25/32)	81 (3-3/16)	119.5 (4-3/4)	114.5 (4-43/64)	6 (15/64)	2 - 4.5 (2 -3/16)	60 (2-23/64)	35 (1-3/8)
100Q-C37	45 (1-25/32)	81 (3-3/16)	136.5 (5-37/64)	131.6 (5-11/32)	6.5 (1/4)	2 - 4.5 (2 -3/16)	60 (2-23/64)	35 (1-3/8)

Table 8 - DC Contactors with Conventional Coils

Cat. No.	a	b	c	c1	c2	Ø d	d1	d2
100Q-C16	45 (1-25/32)	81 (3-3/16)	145.5 (5-49/64)	140.5 (5-37/64)	6 (15/64)	2 - 4.5 (2 -3/16)	60 (2-23/64)	35 (1-3/8)
100Q-C37	45 (1-25/32)	81 (3-3/16)	180.5 (7-5/32)	175.5 (6-61/64)	6.5 (1/4)	2 - 4.5 (2 -3/16)	60 (2-23/64)	35 (1-3/8)

Table 9 - DC Contactors with 36...48V, 48...72V, 110...125V, or 200...250V DC Electronic Coils

Cat. No.	a	b	c	c1	c2	Ø d	d1	d2
100Q-C16EA, -ED, or -EY	45 (1-25/32)	105 (4-1/8)	119.5 (4-3/4)	114.5 (4-43/64)	6 (15/64)	2 - 4.5 (2 -3/16)	60 (2-23/64)	35 (1-3/8)
100Q-C37EA, -ED, or -EY	45 (1-25/32)	105 (4-1/8)	136.5 (5-37/64)	131.6 (5-11/32)	6.5 (1/4)	2 - 4.5 (2 -3/16)	60 (2-23/64)	35 (1-3/8)

100-D/104-D, 100S-D Contactors

Coil Voltage Codes

100-D/104-D Contactors

The Cat. No. as listed is incomplete. Select a coil voltage code from the table below to complete the Cat. No. Example: 120V, 60 Hz: Cat. No. 100-D115Ø11 becomes Cat. No.100-D115D11.

AC Voltages [V], Conventional Coil		24	48	100	110	120	200	208	220...230	230	240	277	380...400
100-D115...100-D180	50 Hz	K	Y	—	D	—	—	—	A	—	T	—	N
	60 Hz	J	X	—	—	D	—	H	—	—	A	T	—
100-D115	50/60 Hz	—	—	KP	KN	—	KG	—	KL	KF	KA	KT	—

AC Voltages [V], Conventional Coil		415	440	480	500	550	600
100-D115...100-D180	50 Hz	B	G	—	M	C	—
	60 Hz	—	N	B	—	—	C
100-D115	50/60 Hz	—	—	—	—	—	—

AC Voltages [V], Electronic Coil w/ El. Interface ⁽¹⁾		24	42...64	100	110...130	200	208...277	200...220
100-D115...100-D300	50/60 Hz	EJ ⁽²⁾	EY	—	ED	—	EA	—
100-D420	50/60 Hz	—	—	—	ED	—	EA	—
100-D630...100-D860	50/60 Hz	—	—	EP	ED	EG	—	EG

AC Voltages [V], Electronic Coil w/ El. Interface ⁽¹⁾		230...250	277	380...415	380...500	440...480	500
100-D115...100-D300	50/60 Hz	—	—	—	EN	—	—
100-D420	50/60 Hz	—	—	—	EN	—	—
100-D630...100-D860	50/60 Hz	EA	ET	EN	—	EB	EM

(1) Signal voltage of the Cat. No. 100-D... electronic interface: nominal U_e : 24V DC/ I_e : 15 mA

Pickup voltage: 13.0V DC...30.2V DC

Dropout Voltage: -3.0V DC...+5.0V DC

(2) Not available with 100/104-D300.

DC Voltages [V], Conventional Coil		24	48	110	125	220
100-D115...100-D180 ⁽¹⁾		ZJ	ZY	ZD	ZS	ZA

(1) For conventional DC coils, the pickup winding must be interconnected with the N.C. late-breaking auxiliary contact(s).

DC Voltages [V], Electronic Coil w/ El Interface ⁽¹⁾		24	48...72	110...130	200...255
100-D115...100-D300		EZJ	EZY	EZD	EZA
100-D420		—	—	EZD	EZA
100-D630...100-D860		—	—	ED	EA

(1) Signal voltage of the Cat. No. 100-D... electronic interface: nominal U_e : 24V DC/ I_e : 15 mA

Pickup voltage: 13.0V DC...30.2V DC, Dropout Voltage: -3.0V DC...+5.0V DC.

100S-D Safety Contactors

The Cat. No. as listed is incomplete. Select a coil voltage code from the table below to complete the Cat. No. Example: 120V, 60 Hz: Cat. No. 100S-D115⊗22BC becomes Cat. No.100S-D115D22BC.

AC Voltages [V], Conventional Coil		24	48	100	110	120	200	208	220...230	230	240	277
100S-D115...100S-D180	50 Hz	K	Y	—	D	—	—	—	A	—	T	—
	60 Hz	J	X	—	—	D	—	H	—	—	A	T
100S-D115	50/60 Hz	—	—	KP	KN	—	KG	—	KL	KF	KA	KT

AC Voltages [V], Conventional Coil		380...400	415	440	480	500	550	600
100S-D115...100S-D180	50 Hz	N	B	G	—	M	C	—
	60 Hz	—	—	N	B	—	—	C
100S-D115	50/60 Hz	—	—	—	—	—	—	—

AC Voltages [V], Electronic Coil w/ EI Interface ⁽¹⁾		24	42...64	100	110...130	200	208...277	200...220
100S-D115...100S-D300	50/60 Hz	EJ ⁽²⁾	EY	—	ED	—	EA	—
100S-D420	50/60 Hz	—	—	—	ED	—	EA	—
100S-D630...100S-D860	50/60 Hz	—	—	EP	ED	EG	—	EG

AC Voltages [V], Electronic Coil w/ EI Interface ⁽¹⁾		230...250	277	380...415	380...500	440...480	500
100S-D115...100S-D300	50/60 Hz	—	—	—	EN	—	—
100S-D420	50/60 Hz	—	—	—	EN	—	—
100S-D630...100S-D860	50/60 Hz	EA	ET	EN	—	EB	EM

(1) Signal voltage of the Cat. No. 100S-D... electronic interface: nominal U_e : 24V DC/ I_e : 15 mA

Pickup voltage: 13.0V DC...30.2V DC

Dropout Voltage: -3.0V DC...+5.0V DC

(2) Not available with 100S-D300

DC Voltages [V], Conventional Coil		24	48	110	125	220	250
100S-D115...100S-D180		ZJ	ZY	ZD	ZS	ZA	ZT

DC Voltages [V], Electronic Coil w/ EI Interface ⁽¹⁾		24	48...72	110...130	200...255
100S-D115...100S-D300		EZJ	EZY	EZD	EZA
100S-D420		—	—	EZD	EZA
100S-D630...100S-D860		—	—	ED	EA

(1) Signal voltage of the Cat. No. 100S-D... electronic interface: nominal U_e : 24V DC/ I_e : 15 mA

Pickup voltage: 13.0V DC...30.2V DC, Dropout Voltage: -3.0V DC...+5.0V DC.

Specifications

			100/104-D,100S-D										
			115	140	140	180	180	210	250	300	420	630	860
Coil Type:	Conventional		X	X	—	X	—	—	—	—	—	—	—
	Electronic — EI		X	—	X	—	X	X	X	X	X	X	X
AC-1 Active Power Load (50 Hz); Ambient temperature 40 °C													
Rated Operational Current, I_e	≤500V	[A]	250	250	250	250	250	350	350	450	540	800	1000
	690V	[A]	250	250	250	250	250	350	350	450	540	800	1000
	1000V	[A]	250	250	250	250	250	350	350	450	540	—	—
	230V	[kW]	100	100	100	100	100	139	139	179	199	319	398
	240V	[kW]	104	104	104	104	104	145	145	187	208	333	416
	400V	[kW]	173	173	173	173	173	242	242	312	346	554	693
	415V	[kW]	180	180	180	180	180	252	252	323	359	575	719
	500V	[kW]	217	217	217	217	217	303	303	390	433	693	866
	690V	[kW]	299	299	299	299	299	418	418	538	598	956	1195
	1000V	[kW]	433	433	433	433	433	606	606	779	866	—	—
AC-1 Active Power Load (50 Hz); Ambient temperature 60 °C													
Rated Operational Current, I_e	≤500V	[A]	210	210	210	210	210	300	300	380	425	—	—
	690V	[A]	210	210	210	210	210	300	300	380	425	—	—
	1000V	[A]	210	210	210	210	210	300	300	380	425	—	—
	230V	[kW]	84	84	84	84	84	120	120	151	169	—	—
	240V	[kW]	87	87	87	87	87	125	125	158	177	—	—
	400V	[kW]	145	145	145	145	145	208	208	263	294	—	—
	415V	[kW]	151	151	151	151	151	216	216	273	305	—	—
	500V	[kW]	182	182	182	182	182	260	260	329	368	—	—
	690V	[kW]	251	251	251	251	251	359	359	454	508	—	—
	1000V	[kW]	364	364	364	364	364	520	520	658	736	—	—
Switching of 3-phase Motors; (50 Hz) Ambient temperature 60 °C, AC-2, AC-3													
Rated Operational Current, I_e	230V	[A]	115	140	140	180	180	210	250	300	420	630	860
	240V	[A]	115	140	140	180	180	210	250	300	420	630	860
	400V	[A]	115	140	140	180	180	210	250	300	420	630	860
	415V	[A]	115(130) ⁽¹⁾	140(155) ⁽¹⁾	140(155) ⁽¹⁾	180(189) ⁽¹⁾	180(189) ⁽¹⁾	210(227) ⁽¹⁾	250(258) ⁽¹⁾	300(315) ⁽¹⁾	420	630	860
	500V	[A]	115	115	140	140	180	210	250	300	420	630	753
	690V	[A]	115	115	140	140	180	210	250	300	420	492	—
	1000V	[A]	46	55	55	65	65	80	95	115	160	—	—
	230V	[kW]	37	45	45	57	57	67	80	97	135	200	250
	240V	[kW]	38	47	47	60	60	70	83	101	141	200	250
	400V	[kW]	64	78	78	101	101	118	140	170	238	355	500
	415V	[kW]	66(75) ⁽¹⁾	82(90) ⁽¹⁾	82(90) ⁽¹⁾	105(110) ⁽¹⁾	105(110) ⁽¹⁾	122(132) ⁽¹⁾	145(150) ⁽¹⁾	176(185) ⁽¹⁾	250	355	500
	500V	[kW]	80	80	98	98	126	147	177	213	298	450	560
	690V	[kW]	111	111	135	135	176	205	250	293	424	500	—
	1000V	[kW]	63	75	75	90	90	110	132	160	225	—	—

(1) 415 V: values in () AC-2 and AC-3 lifespan -25 %

		100/104-D,100S-D											
		115	140	140	180	180	210	250	300	420	630	860	
Coil Type:	Conventional	X	X	—	X	—	—	—	—	—	—	—	—
	Electronic — EI	X	—	X	—	X	X	X	X	X	X	X	X

Load Carrying Capacity per UL/CSA

General Purpose Current (enclosed)		[A]	220	220	220	220	220	300	300	340	420	630	860
Rated power (enclosed) 1-phase	115V	[A]	100	135	135	—	—	—	—	—	—	—	—
	230V	[A]	110	136	136	176	176	216	—	—	—	—	—
	115V	[Hp]	10	15	15	—	—	—	—	—	—	—	—
	230V	[Hp]	25	30	30	40	40	50	—	—	—	—	—
Rated power (enclosed) 3-phase	200V	[A]	120	120	120	150	150	177	221	285	414	552	692
	230V	[A]	104	130	130	154	154	192	248	312	420	602	720
	460V	[A]	96	124	124	180	180	180	240	302	414	590	702
	575V	[A]	99	125	125	144	144	192	242	289	382	562	651
	200V	[Hp]	40	40	40	50	50	60	75	100	150	200	250
	230V	[Hp]	40	50	50	60	60	75	100	125	175	250	300
	460V	[Hp]	75	100	100	150	150	150	200	250	350	500	600
	575V	[Hp]	100	125	125	150	150	200	250	300	400	600	700

Switching of 3-phase Motors, (50 Hz); Ambient temperature 60 °C, AC-4

	230V	[A]	115	140	140	180	180	210	250	300	420	—	—
	240V	[A]	115	140	140	180	180	210	250	300	420	—	—
	400V	[A]	115	140	140	180	180	210	250	300	420	—	—
	415V	[A]	115(130) ⁽²⁾	140(155) ⁽²⁾	140(155) ⁽²⁾	180(189) ⁽³⁾	180(189) ⁽³⁾	210(227)‡	250(258)‡	300(315)‡	420	—	—
	500V	[A]	115	115	140	140	170	210	250	300	360	—	—
	690V	[A]	115	115	140	140	170	210	250	300	360	—	—
	1000V	[A]	46	55	55	65	65	80	95	115	160	—	—
	230V	[kW]	37	45	45	57	57	67	80	97	135	—	—
	240V	[kW]	39	47	47	60	60	70	83	101	141	—	—
	400V	[kW]	63	78	78	100	100	118	140	170	238	—	—
	415V	[kW]	66(75) ⁽²⁾	82(90) ⁽²⁾	82(90) ⁽²⁾	105(110) ⁽²⁾	105(110) ⁽²⁾	125(132) ⁽²⁾	145(150) ⁽²⁾	176(185) ⁽²⁾	250	—	—
	500V	[kW]	80	80	98	98	119	147	177	213	255	—	—
	690V	[kW]	110	110	135	135	167	205	250	293	356	—	—
	1000V	[kW]	63	75	75	90	90	110	132	160	225	—	—

AC-4 at approximately 200,000 operations

	230V	[A]	53	60	60	67	67	85	105	140	170	—	—
	240V	[A]	53	60	60	67	67	85	105	140	170	—	—
	400/415V	[A]	53	60	60	67	67	85	105	140	170	—	—
	500V	[A]	53	60	60	67	67	85	105	140	170	—	—
	690V	[A]	53	60	60	67	67	85	105	140	170	—	—
	1000V	[A]	25	37	37	43	43	60	72	85	105	—	—
	230V ⁽¹⁾	[kW]	15	17	17	20	20	25	32	45	55	—	—
	240V ⁽¹⁾	[kW]	15	18.5	18.5	22	22	25	32	45	55	—	—
	400V ⁽¹⁾	[kW]	25	32	32	37	37	45	55	75	90	—	—
	415V ⁽¹⁾	[kW]	25	32	32	37	37	50	55	80	100	—	—
	500V ⁽¹⁾	[kW]	32	40	40	45	45	55	75	100	110	—	—
	690V ⁽¹⁾	[kW]	45	55	55	63	63	80	100	132	160	—	—
1000V ⁽¹⁾	[kW]	30	50	50	55	55	80	100	110	150	—	—	
Max. switching frequency	Ops/hour	120	120	120	100	100	120	100	70	70	—	—	

(1) Power ratings at 50 Hz: Preferred values according to IEC 60072-1

(2) 415V: Values in () AC-3 and AC-4 lifespan -25%

(3) Approval pending on Cat. No. 100-D210...D860.

			100/104-D,1005-D										
			115	140	140	180	180	210	250	300	420	630	860
Coil Type:	Conventional		X	X	—	X	—	—	—	—	—	—	—
	Electronic — EI		X	—	X	—	X	X	X	X	X	X	X
Wye-Delta (60 Hz)													
	200V	[Hp]	60	60	60	75	75	100	125	175	250	—	—
	230V	[Hp]	60	75	75	100	100	125	175	200	250	—	—
	460V	[Hp]	125	175	175	200	200	250	350	450	600	—	—
	575V	[Hp]	150	200	200	250	250	300	450	500	650	—	—
UL/CSA Elevator Duty													
	200V	[A]	78	92	92	120	120	150	150	177	221	—	—
	230V	[A]	80	104	104	130	130	130	154	192	248	—	—
	460V	[A]	77	96	96	124	124	156	180	180	240	—	—
	575V	[A]	77	77	77	99	99	125	144	192	242	—	—
	200V	[Hp]	25	30	30	40	40	50	50	60	75	—	—
	230V	[Hp]	30	40	40	50	50	50	60	75	100	—	—
	460V	[Hp]	60	75	75	100	100	125	150	150	200	—	—
	575V	[Hp]	75	75	75	100	100	125	150	200	250	—	—
Star-Delta Starting (50 Hz)													
	≤ 230V	[A]	199	242	242	312	312	364	433	520	727	—	—
	≤ 240V	[A]	199	242	242	312	312	364	433	520	727	—	—
	400V	[A]	199	242	242	312	312	364	433	520	727	—	—
	415V	[A]	199 (225) ⁽²⁾	242(268) ⁽²⁾	242 (268) ⁽²⁾	312 (332) ⁽²⁾	312 (332) ⁽²⁾	364 (393) ⁽²⁾	433 (447) ⁽²⁾	520 (546) ⁽²⁾	727	—	—
	500V	[A]	199	199	242	312	312	364	433	520	727	—	—
	690V	[A]	199	199	242	312	312	364	433	520	727	—	—
	1000V	[A]	80	95	95	113	113	139	165	200	277	—	—
	230V ⁽¹⁾	[kW]	63	75	75	90	90	110	132	160	220	—	—
	240V ⁽¹⁾	[kW]	66	80	80	100	100	125	150	160	250	—	—
	400V ⁽¹⁾	[kW]	110	132	132	160	160	200	250	300	425	—	—
	415V ⁽¹⁾	[kW]	114 (132) ⁽²⁾	132 (160) ⁽²⁾	132 (160) ⁽²⁾	160	160	220	250	315 (335) ⁽²⁾	425	—	—
	500V ⁽¹⁾	[kW]	132	132	160	200	200	250	315	375	530	—	—
	690V ⁽¹⁾	[kW]	192	200	220	300	300	355	425	530	750	—	—
	1000V ⁽¹⁾	[kW]	110	132	132	160	160	200	220	280	400	—	—

(1) Power ratings at 50 Hz: Preferred values according to IEC 60072-1

(2) 415V: Values in () AC-3 and AC-4 lifespan -25%

		100/104-D,100S-D											
		115	140	140	180	180	210	250	300	420	630	860	
Coil Type:	Conventional	X	X	—	X	—	—	—	—	—	—	—	—
	Electronic — EI	X	—	X	—	X	X	X	X	X	X	X	X

Switching of Power Transformers, AC-6a (50 Hz)

Inrush Current	Rated transformer current	=n											
n=30			≤ 230V	[A]	60	70	70	85	85	105	125	150	210
	≤ 240V	[A]	60	70	70	85	85	105	125	150	210	—	—
	≤ 400V	[A]	60	70	70	85	85	105	125	150	210	—	—
	≤ 415V	[A]	60	70	70	85	85	105	125	150	210	—	—
	≤ 500V	[A]	60	70	70	85	85	105	125	150	210	—	—
	≤ 690V	[A]	60	70	70	85	85	105	125	150	210	—	—
	≤ 1000V	[A]	46	70	70	85	85	105	125	150	210	—	—
	230V	[kVA]	24	28	28	34	34	42	50	60	84	—	—
	240V	[kVA]	26	29	29	35	35	44	52	62	87	—	—
	400V	[kVA]	42	48	48	59	59	73	87	104	145	—	—
	415V	[kVA]	43	50	50	61	61	75	90	108	151	—	—
	500V	[kVA]	52	61	61	74	74	91	108	130	182	—	—
	690V	[kVA]	72	84	84	102	102	125	149	179	251	—	—
	1000V	[kVA]	80	121	121	147	147	182	217	260	364	—	—
n=20	≤ 690V	[A]	90	105	105	128	128	158	188	225	315	—	—
n=15	≤ 690V	[A]	120	140	140	170	170	210	250	300	420	—	—

60 Hz Peak Inrush/peak rated transformer current

n=30	[A]	60	70	70	85	85	105	125	150	210	—	—
200V	[kVA]	20.8	24.2	24.2	29.4	29.4	36.4	43.3	52.0	72.7	—	—
208V	[kVA]	21.6	25.2	25.2	30.6	30.6	37.8	45.0	54.0	75.7	—	—
240V	[kVA]	24.9	29.1	29.1	35.3	35.3	43.6	52.0	62.4	87.3	—	—
480V	[kVA]	49.9	58.2	58.2	70.7	70.7	87.3	104	125	175	—	—
600V	[kVA]	62.4	72.7	72.7	88.3	88.3	109	130	156	218	—	—
660V	[kVA]	68.6	80.0	80.0	97.2	97.2	120	143	171	240	—	—

60 Hz Peak Inrush/peak rated transformer current

n=20	[A]	90	105	105	128	128	158	188	225	315	—	—
200V	[kVA]	31.2	36.4	36.4	44.3	44.3	54.7	65.1	77.9	109	—	—
208V	[kVA]	32.4	37.8	37.8	46.1	46.1	56.9	67.7	81.1	113	—	—
240V	[kVA]	37.4	43.6	43.6	53.2	53.2	65.7	78.2	93.5	131	—	—
480V	[kVA]	74.8	87.3	87.3	106	106	131	156	187	262	—	—
600V	[kVA]	93.5	109	109	133	133	164	195	234	327	—	—
660V	[kVA]	103	120	120	146	146	181	215	257	360	—	—

60 Hz Peak Inrush/peak rated transformer current

n=15	[A]	120	140	140	170	170	210	250	300	420	—	—
200V	[kVA]	41.6	48.5	48.5	58.9	58.9	72.7	86.6	104	145	—	—
208V	[kVA]	43.2	50.4	50.4	61.2	61.2	75.7	90.1	108	151	—	—
240V	[kVA]	49.9	58.2	58.2	70.7	70.7	87.3	104	125	175	—	—
480V	[kVA]	99.8	116	116	141	141	175	208	249	349	—	—
600V	[kVA]	125	145	145	177	177	218	260	312	436	—	—
660V	[kVA]	137	160	160	194	194	240	286	343	480	—	—

		100/104-D,1005-D											
		115	140	140	180	180	210	250	300	420	630	860	
Coil Type:	Conventional	X	X	—	X	—	—	—	—	—	—	—	—
	Electronic — EI	X	—	X	—	X	X	X	X	X	X	X	X

Switching of 3-phase Capacitors, AC-6b (50 Hz)

Single capacitor 40°C	230V	[kVar]	45	70	70	70	70	98	98	125	139	—	—
	240V	[kVar]	47	73	73	73	73	102	102	131	145	—	—
	400V	[kVar]	78	121	121	121	121	170	170	218	242	—	—
	415V	[kVar]	81	126	126	126	126	176	176	226	252	—	—
	500V	[kVar]	97	152	152	152	152	212	212	273	303	—	—
	690V	[kVar]	134	209	209	209	209	293	293	376	418	—	—
	1000V	[kVar]	194	303	303	303	303	424	424	546	606	—	—
Single capacitor 60 °C	230V	[kVar]	38	59	59	59	59	84	84	106	119	—	—
	240V	[kVar]	39	61	61	61	61	87	87	111	124	—	—
	400V	[kVar]	65	102	102	102	102	145	145	184	206	—	—
	415V	[kVar]	68	106	106	106	106	151	151	191	214	—	—
	500V	[kVar]	82	127	127	127	127	182	182	230	258	—	—
	690V	[kVar]	113	176	176	176	176	251	251	318	356	—	—
	1000V	[kVar]	164	255	255	255	255	364	364	461	515	—	—
Group capacitors 40°C	230V	[kVar]	45	70	70	70	70	98	98	125	139	—	—
	240V	[kVar]	47	73	73	73	73	102	102	131	145	—	—
	400V	[kVar]	56	76	76	111	111	170	170	218	242	—	—
	415V	[kVar]	56	76	76	112	112	170	176	226	252	—	—
	500V	[kVar]	56	76	76	113	113	172	212	273	303	—	—
	690V	[kVar]	57	78	78	114	114	174	247	356	418	—	—
	1000V	[kVar]	58	79	79	116	116	177	251	361	606	—	—
Group capacitors 60 °C	230V	[kVar]	38	59	59	59	59	84	84	106	119	—	—
	240V	[kVar]	39	61	61	61	61	87	87	111	124	—	—
	400V	[kVar]	56	76	76	102	102	145	145	184	206	—	—
	415V	[kVar]	56	76	76	106	106	151	151	191	214	—	—
	500V	[kVar]	56	76	76	113	113	172	182	230	258	—	—
	690V	[kVar]	57	78	78	114	114	174	247	318	356	—	—
	1000V	[kVar]	58	79	79	116	116	177	251	361	515	—	—
60 Hz Single Capacitor — 40 °C	200V	[kVar]	39	61	61	61	61	85	85	109	121	—	—
	230V	[kVar]	45	70	70	70	70	98	98	125	139	—	—
	460V	[kVar]	89	139	139	139	139	195	195	251	279	—	—
	600V	[kVar]	116	182	182	182	182	255	255	327	364	—	—
60 Hz Group Capacitors — 40 °C	200V	[kVar]	39	61	61	61	61	85	85	109	121	—	—
	230V	[kVar]	45	70	70	70	70	98	98	125	139	—	—
	460V	[kVar]	56	76	76	112	112	171	195	251	279	—	—
	600V	[kVar]	57	77	77	114	114	173	246	327	364	—	—



Switching of Lamps

Gas discharge lamps AC-5a, 40 °C													
open	[A]	144	225	225	225	225	315	315	405	450	—	—	—
enclosed	[A]	122	189	189	189	189	270	270	342	383	—	—	—
Individually compensated:													
Max. capacitance at expected													
Filament AC-5b	230/240V	[A]	120	140	140	170	170	210	250	300	420	—	—

			100/104-D,100S-D										
			115	140	140	180	180	210	250	300	420	630	860
Coil Type:	Conventional		X	X	—	X	—	—	—	—	—	—	—
	Electronic — EI		X	—	X	—	X	X	X	X	X	X	X
Switching of Hermetically Sealed Cooling Compressor Motors - manual reset of overload release (50 Hz)													
AC-8a	400V	[A]	192	210	210	—	—	—	—	—	—	—	—
	500V	[A]	192	192	210	—	—	—	—	—	—	—	—
	690V	[A]	192	192	210	—	—	—	—	—	—	—	—
Switching of DC Loads													
Non-inductive or slightly inductive loads or resistance furnaces DC-1, 60 °C													
1 pole	24V	[A]	135	210	210	210	210	300	300	380	425	—	—
	48/60V	[A]	135	210	210	210	210	300	300	380	425	—	—
	110V	[A]	135	210	210	210	210	300	300	380	425	—	—
	220V	[A]	3	3.3	3.3	3.3	3.3	4.9	4.9	4.9	5.2	—	—
	440V	[A]	0.6	0.75	0.75	0.75	0.75	1	1	1	1.2	—	—
2 poles in series	24V	[A]	135	210	210	210	210	300	300	380	425	—	—
	48/60V	[A]	135	210	210	210	210	300	300	380	425	—	—
	110V	[A]	135	210	210	210	210	300	300	380	425	—	—
	220V	[A]	135	210	210	210	210	300	300	380	425	—	—
	440V	[A]	3	3.3	3.3	3.3	3.3	4.9	4.9	4.9	5.2	—	—
3 poles in series	24V	[A]	135	210	210	210	210	300	300	380	425	—	—
	48/60V	[A]	135	210	210	210	210	300	300	380	425	—	—
	110V	[A]	135	210	210	210	210	300	300	380	425	—	—
	220V	[A]	135	210	210	210	210	300	300	380	425	—	—
	440V	[A]	11	11	11	11	11	14	14	14	15	—	—
Shunt-wound Motors, Starting, reverse current braking, reversing, stepping DC-3, 60°C													
3 poles in series	24V	[A]	135	210	210	210	210	300	300	380	425	—	—
	48/60V	[A]	135	210	210	210	210	300	300	380	425	—	—
	110V	[A]	135	210	210	210	210	300	300	380	425	—	—
	220V	[A]	135	210	210	210	210	300	300	380	425	—	—
	440V	[A]	3	3.5	3.5	3.5	3.5	4.1	4.1	4.1	5.8	—	—
Series-wound Motors, Starting, reverse current braking, reversing, stepping DC-5, 60 °C													
3 poles in series	24V	[A]	135	210	210	210	210	300	300	380	425	—	—
	48/60V	[A]	135	210	210	210	210	300	300	380	425	—	—
	110V	[A]	135	210	210	210	210	300	300	380	425	—	—
	220V	[A]	135	210	210	210	210	300	300	380	425	—	—
	440V	[A]	1.2	2.1	2.1	2.1	2.1	2.4	2.4	2.4	3	—	—
Short Time Withstand I_{CW} , 60 °C	10 s	[A]	1040	1240	1360	1480	1480	2360	2520	2840	4700	6300	7000
Resistance and Power Dissipation													
Main current circuit resistance	[mΩ]		0.4	0.42	0.42	0.42	0.42	0.22	0.22	0.18	0.15	0.19	0.14
Power dissipation by all circuits at I_e AC-3/400V	[W]		14.5	24.6	24.6	40.8	40.8	29.4	41.7	48.6	79.5	226.2	310.6
Total power dissipation At I_e AC-3/400V	AC control	[W]	24.5(20.5)	34.6	30.6	50.8	46.8	35.4	47.7	54.6	86.5	105.4	133.2
	DC control	[W]	22.5(20.5)	32.6	30.6	48.8	46.8	35.4	47.7	54.6	86.5	105.4	133.2
Lifespan													
Mechanical AC control	[Million ops.]		10	10	10	10	10	10	10	10	10	2	2
Mechanical DC control	[Million ops.]		10	10	10	10	10	10	10	10	10	2	2
Electrical AC-3 (400 V)	[Million ops.]		1	1	1	1	1	1	1	1	1	—	—

			100/104-D,100S-D										
			115	140	140	180	180	210	250	300	420	630	860
Coil Type:	Conventional		X	X	—	X	—	—	—	—	—	—	—
	Electronic — EI		X	—	X	—	X	X	X	X	X	X	X
Weight													
AC	Non-Rev.	[kg (lbs)]	3.3(7.28) [3.8 (8.38)] ⁽¹⁾	3.3 (7.28)	3.8 (8.38)	3.3 (7.28)	3.8 (8.38)	7.5 (16.53)	7.5 (16.53)	7.5 (16.53)	7.5 (16.53)	28.6 (63)	28.6 (63)
	Rev.	[kg (lbs)]	3.14 (6.92)	—	—	—	—	—	—	—	—	—	—
DC	Non-Rev.	[kg (lbs)]	3.3(7.28) [3.8 (8.38)] ⁽¹⁾	3.3 (7.28)	3.8 (8.38)	3.3 (7.28)	3.8 (8.38)	7.5 (16.53)	7.5 (16.53)	7.5 (16.53)	7.5 (16.53)	28.6 (63)	28.6 (63)
	Rev.	[kg (lbs)]	3.22(7.1)	—	—	—	—	—	—	—	—	—	—

(1) Values in brackets refer to electronic coil (EI) version.

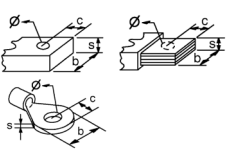
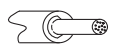
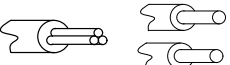
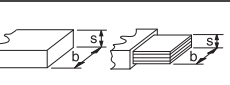
			100/104-D,100S-D								
			115	140	180	210	250	300	420	630	860
Coil Type:	Conventional		X	X	X	—	—	—	—	—	—
	Electronic — EI		X	X	X	X	X	X	X	X	X
Conductor Cross Sections - Main Contacts Terminal type											
	b max.	[mm]	25		30			52			
	c max.	[mm]	12.5		15			22			
	s max.	[mm]	5		6			2 x 8			
	Ø min.	[mm]	8.3		10.5			13			
Recommended torque		[N·m]	22		43			68			
Recommended torque		[lb-in]	195		380			600			
With terminal lug kit			100-DL180S		100-DL420S			100-DL630		100-DL860	
Cross section per UL/CSA		[AWG]	6...300 MCM		(2x) 4...350 MCM			(2X) 2/0...500 MCM		(4X) 2/0...500 MCM	
Recommended torque		[lb-in]	88...106		375			400		400	
With Frame Terminal Block			100-DTB180 ⁽¹⁾		100-DTB420 ⁽²⁾			—		—	
	top opening	[mm ²]	16...35		25...185Δ			—		—	
	bottom opening	[mm ²]	16...95		25...185			—		—	
	top opening	[mm ²]	16...50		25...240			—		—	
	bottom opening	[mm ²]	16...120		25...240			—		—	
	b max.	[mm]	20		25			—		—	
	s top	[mm]	3...9		6...20			—		—	
	s bottom	[mm]	3...14		6...20			—		—	
Recommended torque		[N·m]	14		25			—		—	
Cross section per UL/CSA	top	[AWG]	6...1/0 AWG		4 AWG...600 MCM			—		—	
	bottom	[AWG]	6 AWG...250 MCM		4 AWG...600 MCM			—		—	
Recommended torque		[lb-in]	124		220			—		—	

(1) Hexagonal socket screw

(2) Pozidriv No. 2 / Blade No. 3 screw

Short-Circuit Coordination Data

See www.ab.com/certifications/ul508a for complete short-circuit current ratings.

		100/104-D, 100S-D									
		115	140/180	140	180	210	250	300	420	630	860
Coil Type:	Conventional	X	X	—	—	—	—	—	—	—	—
	Electronic - EI	X	—	X	X	X	X	X	X	X	X
Short Circuit Coordination (Max. Fuse or Circuit Breaker Rating) Per IEC 60947-4-1 (contactor and fuses only)											
DIN Fuses- gG, gL		50 kA Available Fault Current									
Type"1"(690V)	[A]	250	315	315	355	500	500	630	630	TBD	TBD
Type"2"(400V)	[A]	200	250	250	315	400	400	500	500	TBD	TBD
Type"2"(690V)	[A]	200	250	250	315	400	400	500	500	TBD	TBD
BS88Fuses											
Type"1"(415V)	[A]	200	250	250	250	355	355	450	630	TBD	TBD
Type"2"(415V)	[A]	200	250	250	250	355	355	450	560	TBD	TBD
UL Class K5 and RK5 Fuses		10 kA Available Fault Current									
UL Listed Combination (600V)	[A]	250	350/450	350	450	500	—	—	—	—	—
UL Class L Fuses		18 kA Available Fault Current									
UL Listed Combination (600V)	[A]	—	—	—	—	—	700	700	1000	—	—
UL Class L Fuses		30 kA Available Fault Current									
UL Listed Combination (600V)	[A]	—	—	—	—	—	—	—	—	2000	—
UL Class L Fuses		42 kA Available Fault Current									
UL Listed Combination (600V)	[A]	—	—	—	—	—	—	—	—	—	2500
UL Class J and CSA HRCI-J Fuses		100 kA Available Fault Current									
UL verified combination to IEC 60947-4-1 "Type 2"	[A]	200	250/300	250	300	400	400	500	600	TBD	TBD
UL Inverse-Time Circuit Breaker		10 kA Available Fault Current									
UL Listed Combination (600V)	[A]	150	200/250	200	250	300	—	—	—	—	—
UL Inverse-Time Circuit Breaker		18 kA Available Fault Current									
UL Listed Combination (600V)	[A]	—	—	—	—	—	350	400	500	—	—
UL Inverse-Time Circuit Breaker		25 kA Available Fault Current									
UL Listed Combination (600Y/347V)	[A]	125	200	200	200	250	—	—	—	—	—
UL Inverse-Time Circuit Breaker		30 kA Available Fault Current									
UL Listed Combination (600V)	[A]	—	—	—	—	—	400	400	600	1200	—
UL Inverse-Time Circuit Breaker		42 kA Available Fault Current									
UL Listed Combination (600V)	[A]	—	—	—	—	—	—	—	—	—	1200
UL Inverse-Time Circuit Breaker		65 kA Available Fault Current									
UL Listed Combination (480V)	[A]	125	200	200	200	250	400	400	600	TBD	TBD
UL Inverse-Time Circuit Breaker		65 kA Available Fault Current									
UL Listed Combination (480V)	[A]	125	200	200	200	250	400	400	600	TBD	TBD



Coil Data

			100/104-D,100S-D											
			115	140/180	115	140	180	210	250	300	420	630	860	
Coil Type:	Conventional	X	X	—	—	—	—	—	—	—	—	—	—	
	Electronic - EI	X	—	X	X	X	X	X	X	X	X	X	X	
Operating Limits														
50 Hz, 60 Hz, 50/60 Hz	pick-up	[$x U_s$]	0.85...1.1			0.85...1.1						0.8...1.1		
	dropout	[$x U_s$]	0.3...0.6			0.3...0.5						0.1...0.8		
DC control	pick-up	[$x U_s$]	0.85...1.1			0.85...1.1						0.85...1.1		
	dropout	[$x U_s$]	0.3...0.6			0.3...0.5						0.1...0.8		
Coil Consumption														
50 Hz, 60 Hz, 50/60 Hz	pick-up	[VA/W]	650/310			380/240 ⁽¹⁾				490/270 ⁽¹⁾		1915/1720		
	hold-in	[VA/W]	50/10			13/6				18/7		33/30		
DC control	pick-up	[W]	540			265 ⁽¹⁾				340 ⁽¹⁾		1980 ⁽¹⁾		
	hold-in	[W]	8			6				7		30		
Operating Times														
AC	closing delay	[ms]	20...47			20...45						60...100		
	opening delay	[ms]	6...12			25...110						70...145		
With RC module	closing delay	[ms]	9...18			—						—		
DC	opening delay	[ms]	27...47			25...50						60...100		
	closing delay	[ms]	12...20			35...110						70...145		
With integrated diode	opening delay	[ms]	12...20			—						—		
With external diode	opening delay	[ms]	—			—						—		

(1) Electronic coil drives are designed to minimize power requirements, but this control may exhibit a higher inrush (540 W, < 10 ms) when energizing. This must be taken into account for the proper sizing of supply devices, all-or-nothing relays and cross-sections of coil supply lines. Please contact your local Rockwell Automation sales office or Allen-Bradley distributor for detailed information.

Auxiliary Contacts, Auxiliary Contact Blocks, and Pneumatic Timers

			Side-mounted		
			Conventional	Bifurcated	Electronically Compatible
Switching of AC Loads					
AC-12 I_{th}	at 40 °C	[A]	16	10	0.1
	at 60 °C	[A]	12	6	at 250V
AC-15 at rated voltage of	24V	[A]	5.5	3	(1...100 mA) at 3...125V
	42/48V	[A]	5.5	3	
	120V	[A]	5.5	3	
	230V	[A]	5.5	3	
	240V	[A]	5	3	
	400V	[A]	3	2	
	415V	[A]	2.5	2	
	500V	[A]	1.6	1.2	
690V	[A]	1	0.7		
Switching of DC Loads					
DC-12 L/R < 1 ms resistive loads at	24V DC	[A]	16	16	—
	48V DC	[A]	9	9	—
	110V DC	[A]	3.5	3.5	—
	220V DC	[A]	0.55	0.55	—
	440V DC	[A]	0.2	0.2	—

			Side-mounted		
			Conventional	Bifurcated	Electronically Compatible
DC-14L/R <15 ms inductive loads with economy resistor in series at	24V DC	[A]	9	9	—
	48V DC	[A]	5	5	—
	110V DC	[A]	2	2	—
	220V DC	[A]	0.4	0.4	—
	440V DC	[A]	0.16	0.1	—
DC-13 switching electromagnets at	24V DC	[A]	5	5	(1...100 mA) at 3...125V
	48V DC	[A]	2	2	
	110V DC	[A]	0.7	0.7	
	220V DC	[A]	0.25	0.25	
	440V DC	[A]	0.12	0.12	
Fuse gG					
		[A]	16	16	—
		[A]	16	16	—
Protective Separation per IEC 60947-1, Annex N			between load and auxiliary circuit 440V		
Min. switching capacity according to IEC 60947-5-4			17V/10 mA	5V/2 mA (1 million ops.)	3V/1 mA
Load Carrying Capacity per UL/CSA					
Rated voltage	AC	[V]	max.600		max.250
Continuous rating	40 °C	[A]	10 General purpose		0.1
Switching capacity	AC	[A]	Heavy pilot duty (A600)		0.1
Rated voltage	DC	[V]	max.600		max.250
Switching capacity	DC	[A]	Standard pilot duty (P600)	Standard pilot duty (Q600)	0.1

General

Rated Isolation Voltage U_i		
IEC	[V]	1000
UL,CSA	[V]	600
Rated Impulse Voltage Withstand U_{imp}	[kV]	12
Rated Voltage U_e		
AC 50/60 Hz	[V]	230, 240, 400, 415, 500, 690, 1000
DC	[V]	24, 48, 110, 220, 440
Insulation Class of the Coil		Class B per VDE 0660, Table 22
Rated coil frequency		AC 50 Hz; 50/60Hz DC
Ambient Temperature		
Storage	[°C]	-40...+80
Operation at rated voltage	[°C]	-25...+60
at 70 °C		15% current reduction against 60 °C values
Climatic Withstand		IEC 60068-2-30
Max. Altitude of Installation Site	[m]	2000NN, per IEC60947-4
Protection Class		IP00 IEC 60529/DIN 40050
Single contactor cover		IP10 IEC 60529/DIN 40050
Contactor with frame terminal block		IP20 IEC 60529/DIN 40050
Auxiliary contact		IP20 IEC60529/DIN 40050
Protection against Accidental Contact		Finger-and back-of-hand proof per VDE 0106, part 100
Resistance to Shock		IEC 60068-2-27
Resistance to Vibration		IEC 60068-2-6
Mirror Contacts IEC60947-4 Annex F		100-D...+2 x 100-DS1-11; 100S-D...+2 x 100S-DS1-11

Standards Compliance and Certifications

100-D IEC Contactors

Standards Compliance	Certifications
IEC 60947-4-1	CE Marked
IEC 60947 Type "2" Coordination	CCC (115...180 A - conventional coil; 115...860 A - electronic coil)
CSA 22.2. No. 14	cULus Listed (File No. E 41850, Guide NLDX, NLDX7)
UL 508	

100S-D Safety Contactors

Standards Compliance	Certifications
IEC 60947-4-1	CE Marked
IEC 60947-4 Annex F	cULus Listed (File No. E 41850, Guide NLDX, NLDX7)
IEC 60947 Type "2" Coordination	SUVA Certified
CSA C22.2 No. 14	CCC (115...180 A - conventional coil; 115...860 A - electronic coil)
UL 508	

Life-Load Curves

Figure 21 - AC-3, AC-1

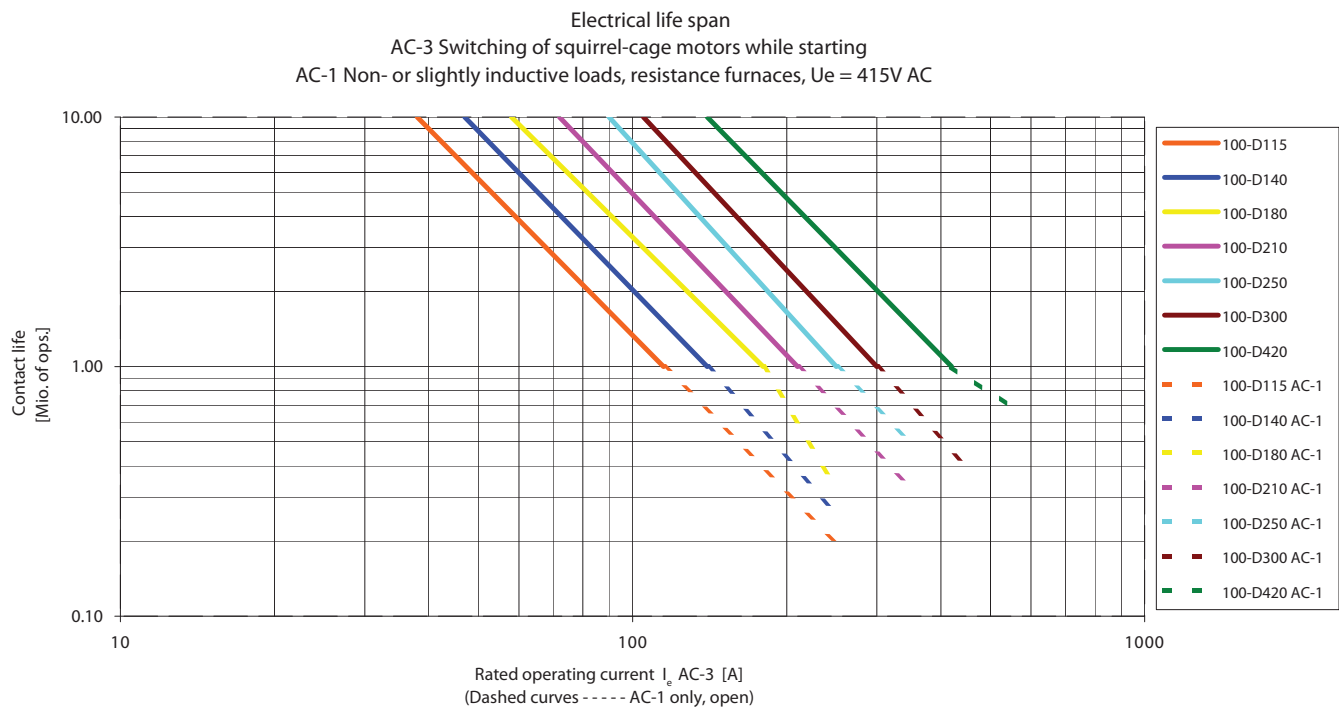

Figure 22 - AC-4

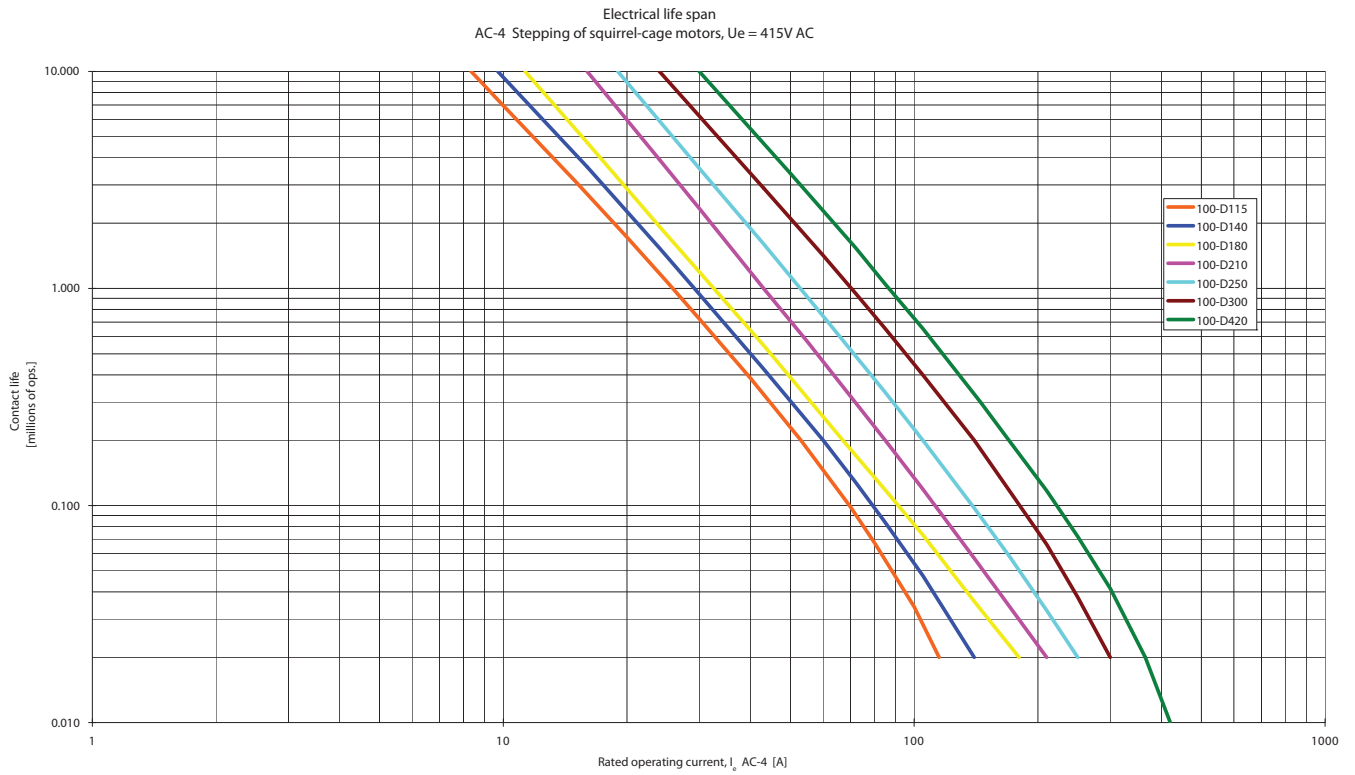
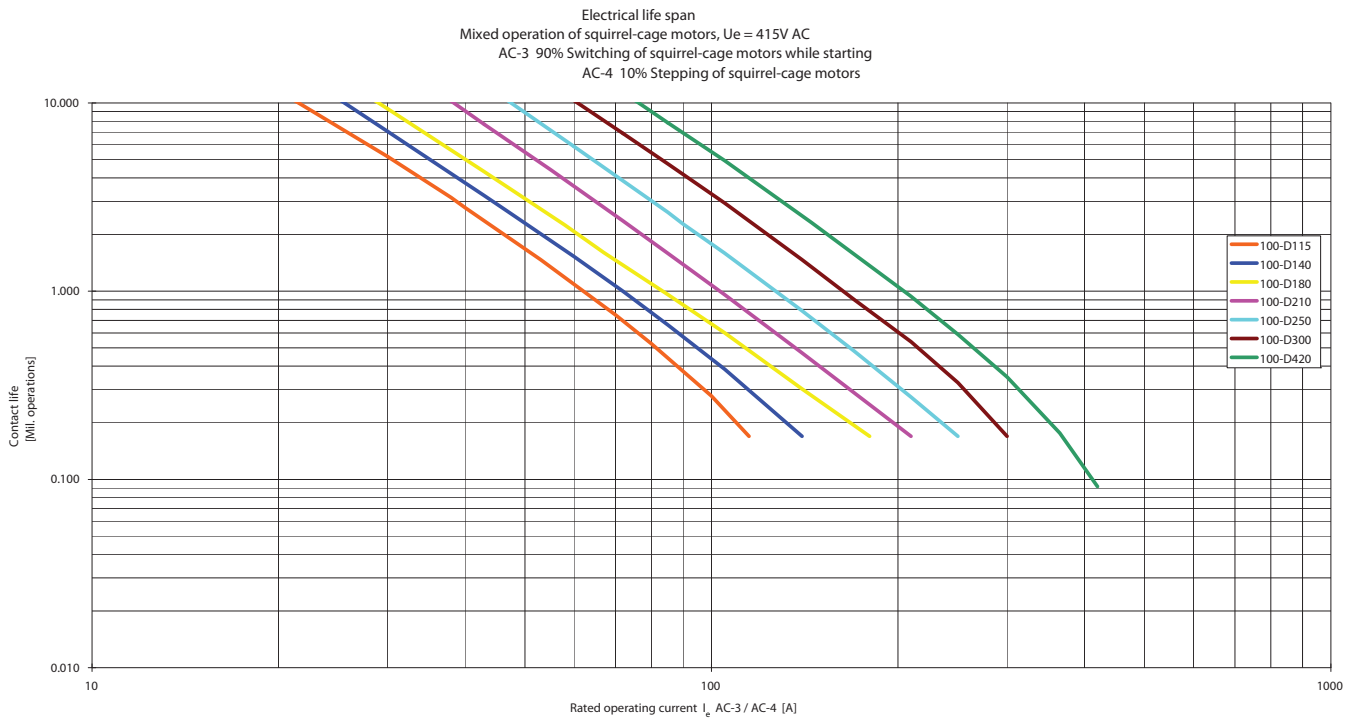

Figure 23 - AC-3 90% and AC-4 10%



Approximate Dimensions

Dimensions are shown in millimeters (inches). Dimensions are not intended for manufacturing purposes.

Bulletin 100-D/104-D, 100S-D Approximate Dimensions

Figure 24 - Bulletin 100-D/100S-D Contactors and Accessories

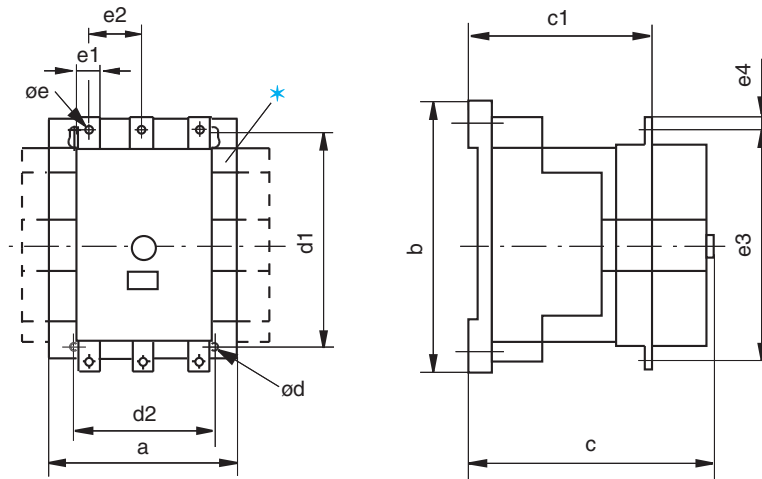

* Conventional DC coil contactors will have an additional auxiliary contact block that will add 13.5 mm to the "a" dimension on the right-hand side.

Figure 25 - Mounting Position, 100-D/104-D Contactors

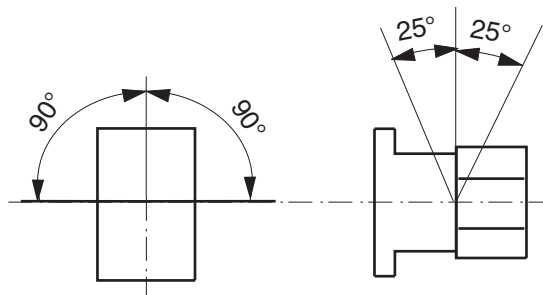
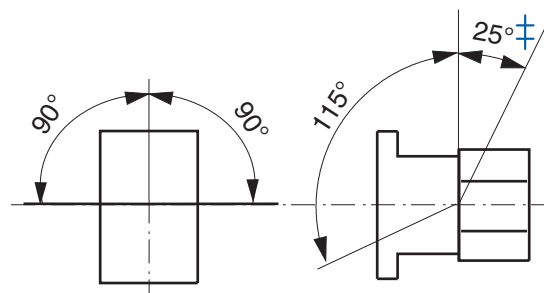

Figure 26 - Mounting Position, 100S-D Contactors



‡ Applies only to conventional single frequency, conventional DC and electronic coils.

Table 10 - AC and DC Contactors

Cat. No.	a	b	c	c1	∅ d	d1	d2	∅ e	e1	e2	e3	e4
100-D115E...100-D180E, 100-D115, 100-D140, 100-D180	120	170	156	110.5	5.2	145	100	8.5	20	39	160	10
100-D210E...100-D420E	155	205	180	110.5	6.5	180	130	10.4	25	48	193	12.5
100-D630E...100-D860E	255	310	265	110.5	10	230	225	M12	40	70	291	22
100S-D115E...100S-D180E, 100S-D115, 100S-D140, 100S-D180	120	170	156	110.5	5.2	145	100	8.5	20	39	160	10
100S-D210E...100S-D420E	155	205	180	110.5	6.5	180	130	10.5	25	48	193	12.5
100S-D630E...100S-D860E	255	310	265	110.5	10	230	225	M12	40	70	291	22

Table 11 - Contactors with Accessories

Contactor with	mm
Auxiliary contact block	100-DS1... 100-DS2... a a + 13.5 each
Mechanical Interlock	100-DM... a + a
Frame terminal block	100-DTB110 100-DTB180 100-DTB420 b + 7 each b + 7 each b + 8.5 each
Label holder	c... + 5

Coil Voltage Codes

The Cat. No. as listed is incomplete. Select a coil voltage code from the table below to complete the Cat. No. Example: 120V, 60 Hz: Cat. No. 100-G550⊗22 becomes Cat. No.100-G550KD22.

AC Voltages [V], Conventional Coil	100...110	110...120	200...220	220...240	345...380	380...415	400...440	440...480	
100-G550...100-G860	50/60 Hz	—	KD	—	KF	—	KN	—	KB
	DC	KD	—	KF	—	KN	—	KB	—

AC Voltages [V], Conventional Coil	110...115	110	220...230	220	240	380...400	440	480	
100-G1000...100-G1200	50/60 Hz	KD	—	KF	—	KA	KN	KB	KU
	DC	—	ZD ⁽¹⁾	—	ZA ⁽¹⁾	—	—	—	—

(1) Consult your local Rockwell Automation sales office or Allen-Bradley distributor.

Specifications

Electrical Data

		100-G550...	100-G700...	100-G860...	100-G1000	100-G1200	
AC-1, Three-phase Switching-IEC							
Ambient temperature: 40 °C							
I_e	≤690V	[A]	760	1000	1100	1200	1350
	≤230V	[kW]	303	398	438	478	538
	≤240V	[kW]	316	416	457	499	561
	≤400V	[kW]	527	693	762	831	935
	≤415V	[kW]	546	719	791	863	970
	≤500V	[kW]	658	866	953	1039	1169
	≤690V	[kW]	908	1195	1315	1434	1613
Ambient temperature: 60 °C							
I_e	≤690V	[A]	605	800	870	960	1,085
	≤230V	[kW]	241	319	347	382	432
	≤240V	[kW]	251	333	362	399	451
	≤400V	[kW]	419	554	603	665	752
	≤415V	[kW]	435	575	625	690	780
	≤500V	[kW]	524	693	753	831	940
	≤690V	[kW]	723	956	1040	1147	1297
Continuous Current - UL/CSA General Purpose Rating 40 °C		[A]	520	700	810	—	1215

			100-G550...	100-G700...	100-G860...	100-G1000	100-G1200
Switching of 3-phase Motors-IEC							
AC-2,AC-3	230/240V	[A]	550	700	860	1000	1200
50Hz/60°C	400/415V	[A]	550	700	860	1000	1200
	500V	[A]	550	700	860	1000	1200
	690V	[A]	500	630	700	860	1000
	230V	[kW]	179	228	280	326	391
	240V	[kW]	187	238	293	340	408
	400V	[kW]	312	414	509	592	710
	415V	[kW]	324	430	528	628	737
	500V	[kW]	407	518	636	756	888
	690V	[kW]	510	657	730	897	1043
AC-4 at 200 000 operations							
50Hz	230/240V	[A]	140	180	210	260	300
	400/415V	[A]	140	180	210	260	300
	230V	[kW]	45	57	67	83	97
	240V	[kW]	47	60	70	87	101
	400V	[kW]	78	101	118	146	170
	415V	[kW]	81	105	122	151	176
AC-4, Squirrel-cage motors with reversing and jogging at 20,000 (25,000),operations							
	230/240V	[A]	360	430	520	(630)	(700)
	400/415V ⁽¹⁾	[A]	350	420	520	(630)	(700)
	230V	[kW]	116	139	170	(205)	(228)
	240V	[kW]	120	151	177	(214)	(245)
	400V	[kW]	198	238	295	(357)	(414)
	415V	[kW]	206	247	300	(359)	(424)

(1) At rated Voltage 415V and rated current: Lifespan -25%.

			100-G550...	100-G700...	100-G860...	100-G1000	100-G1200
Switching of 3-phase Motors-UL/CSA							
60Hz/60°C	200V	[A]	414	552	692	—	1185
	230V	[A]	360	602	722	—	1130
	460V	[A]	414	590	708	—	1062
	575V	[A]	336	472	576	—	864
	200V	[Hp]	150	200	250	—	450
	230V	[Hp]	150	250	300	—	450
	460V	[Hp]	350	500	600	—	900
	575V	[Hp]	350	500	600	—	900
Rated making capacity							
AC-3 I_e	≤415V	[A]	5500	7000	8600	10000	12000
	≤500V	[A]	5500	7000	8600	10000	12000
	≤690V	[A]	5500	7000	8600	10000	12000
Rated making capacity							
AC-3 I_e	≤240V	[A]	4400	5600	6900	8000	9600
	≤400V	[A]	4400	5600	6900	8000	9600
	≤415V	[A]	4400	5600	6900	8000	9600
	≤500V	[A]	4400	5600	6900	8000	9600
	≤690V	[A]	4000	5100	5600	6900	8000

			100-G550...	100-G700...	100-G860...	100-G1000	100-G1200
Star-Delta Starting							
50 Hz	230V	[A]	953	1212	1490	1732	2078
	240V	[A]	953	1212	1490	1732	2078
	400V	[A]	953	1212	1490	1732	2078
	415V	[A]	953	1212	1490	1732	2078
	500V	[A]	953	1212	1490	1732	2078
	690V	[A]	831	1091	1195	1490	1732
	230V	[kW]	310	395	485	565	677
	240V	[kW]	324	412	507	589	707
	400V	[kW]	540	717	882	1025	1250
	415V	[kW]	561	745	915	1088	1278
	500V	[kW]	705	897	1102	1309	1538
	690V	[kW]	883	1138	1247	1554	2078
Wye-Delta Starting							
60 Hz	230V	[Hp]	250	400	500	650	750
	460V	[Hp]	600	800	1000	1300	1500
	575V	[Hp]	600	800	1000	1500	1500
Short-circuit Protection of Contactors without Overload Relay							
Fuse gG (aM) Type 1 coordination (per IEC 60947-4-1)	500V	[A]	(630)	800	1000	1000	1250
	690V	[A]	(630)	800	1000	1000	1000
Switching of Three-phase Capacitor Inductivity of dispatching between parallel switched capacitor: min. 6 pH							
Single capacitors — 40 °C	230V	[kVar]	180	220	250	290	330
	240V	[kVar]	200	250	300	325	360
	400V	[kVar]	320	400	450	500	575
	415V	[kVar]	350	430	500	550	630
	500V	[kVar]	450	520	600	660	750
	690V	[kVar]	580	700	800	875	1000
Single capacitors — 55 °C	230V	[kVar]	150	180	220	275	325
	240V	[kVar]	170	200	260	300	350
	400V	[kVar]	280	330	400	460	550
	415V	[kVar]	300	360	450	500	600
	500V	[kVar]	360	420	540	600	720
	690V	[kVar]	500	580	720	800	950

Cat. No.			100-G550...	100-G700...	100-G860...	100-G1000	100-G1200
Ratings for Switching Capacitor Banks							
40 °C	230V	[kVar]	180	220	250	290	330
	240V	[kVar]	200	250	300	325	360
	400V	[kVar]	320	400	450	500	575
	415V	[kVar]	350	430	500	550	630
	500V	[kVar]	450	520	600	660	750
	690V	[kVar]	580	700	800	875	1000
55 °C	230V	[kVar]	150	180	220	275	325
	240V	[kVar]	170	200	260	300	350
	400V	[kVar]	280	330	400	460	550
	415V	[kVar]	300	360	450	500	600
	500V	[kVar]	360	420	540	600	720
	690V	[kVar]	500	580	720	800	950
DC Switching							
Switching of non-or slightly inductive loads, resistance furnaces; DC-1 at 60°C							
1 Pole	24/48V	[A]	645	760	930	1020	1150

Cat. No.		100-G550...	100-G700...	100-G860...	100-G1000	100-G1200
2 Poles in series	24/48V [A]	645	760	930	1020	1150
3 Poles in series	24/48V [A]	645	760	930	1020	1150
	110V [A]	480	560	630	800	900
	220V [A]	315	400	450	500	600
Shunt-Wound Motors						
Starting, plugging, reversing, plugging; DC-3 at 60 °C						
3 Poles in series	24/48V [A]	605	800	870	960	1085
Series-Wound Motors						
Starting, plugging, reversing, plugging; DC-5 at 60°C						
3 Poles in series	24/48V [A]	605	800	870	960	1085
Lighting Loads; Elec.Discharge.Lamps-AC-5a,						
Non-Compensated	[A]	450	570	700	850	1000
Compensated	[A]	360	460	550	660	800
Incandescent Lamps-AC-5b, Electrical Endurance @100000 ops	[A]	315	440	500	560	630
Switching Power Transformers AC-6a						
Inrush = $n \cdot I_e$	[A]	7440	9450	11700	13500	16200
I_e Rated transformer current	[A]	248	315	390	450	540
n=30	400VAC [kVA]	172	218	270	312	374
	500VAC [kVA]	215	273	338	390	468
	690VAC [kVA]	269	339	376	538	645
n=20	[A]	371	472	580	675	810
n=15	[A]	435	630	774	900	1080
Rated Short-Time Withstand, I_{CW}, 60 °C						
	1s [A]	5500	7000	8000	10000	12000
	4s [A]	5500	7000	8000	10000	12000
	10s [A]	4400	5600	6900	8000	9600
	15s [A]	3800	5000	6000	7400	8500
	60s [A]	2300	2800	3400	4000	4800
	240s [A]	1300	1800	2000	2300	2700
	900s [A]	850	1150	1350	1600	1900
Minimum cooling time at zero current	[Min.]	60	60	60	60	60
Resistance and Energy Dissipation						
Main circuit resistance	[mΩ]	0.11	0.1	0.08	0.06	0.05
Total energy dissipation at I_e AC-3	[W]	99	147	177	180	216
Excess energy dissipation at I_e AC-3	AC Control [W]	110	172	202	250	286
	DC Control [W]	109	169	199	240	276

Mechanical Data

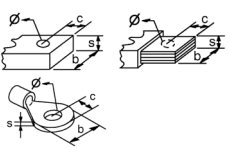
Cat. No.		100-G550...	100-G700...	100-G860...	100-G1000	100-G1200	
Mechanical Life	AC Control	[Million operations]	5	5	5	1	1
	DC Control	[Million operations]	5	5	5	1	1
Shipping Weights	AC Control	[kg]	13.8	26.4	28.4	50.3	53.4
		[lb]	30.4	58.1	62.5	110.8	117.6
	DC Control	[kg]	13.8	26.4	28.4	50.3	53.4
		[lb]	30.4	58.1	62.5	110.8	117.6
Terminals							
Terminal Dimensions		[mm]	6 x 40	8 x 50	8 x 50	10 x 50	10 x 60
Terminal screw hole size		[mm]	(1) x Ø13	(1) x Ø13	(1) x Ø15	(2) x Ø13	(2) x Ø13
Terminations-Power Type			Hexagonal Bolt				
Direct Connection							
	b max.	[mm]	50	60	60	60	60
	c max.	[mm]	20	20	25	25	25
	s max.	[mm]	2x5	2x5	2x6	2x6	2x8
	Ø min.	[mm]	12.5	13	15	2x13	2x13
Recommended Torque		[N•m]	50	60	75	60	60
		[ft.-lb]	37	44	55	44	44
Conductor/Wire Terminations							
Busbar (Width)		[mm]	40	50	50	50	60
Hex screw		[in]	1/2	3/8	3/8	3/8	3/8
Recommended Torque		[N•m]	42	62	62	56	56
		[lb•in]	375	550	550	500	500
Auxiliary Contact		[mm ²]	(2) x 2.5	(2) x 2.5	(2) x 2.5	(2) x 2.5	(2) x 2.5
Coils		[mm ²]	(2) x 2.5	(2) x 2.5	(2) x 2.5	(2) x 2.5	(2) x 2.5

Coil Data

Cat. No.		100-G550...	100-G700...	100-G860...	100-G1000	100-G1200
Operating Limits						
AC-50 Hz	Pick-up	[x U _s]	0.85...1.1			
	Drop-out	[x U _s]	0.2...0.5	0.2...0.75	0.1...0.6	
AC-60 Hz	Pick-up	[x U _s]	0.85...1.1			
	Drop-out	[x U _s]	0.2...0.5	0.2...0.75	0.1...0.6	
DC Control	Pick-up	[x U _s]	0.85...1.1			
	Drop-out	[x U _s]	0.2...0.5	0.2...0.75	0.1...0.6	
Pickup and Holding Power						
AC-50 Hz	Pick-up	[VA]	800...950	1350...1600	2400	
	Hold-in	[VA]	9...11	21...25	70	
AC-60 Hz	Pick-up	[VA]	800...950	1350...1600	2400	
	Hold-in	[VA]	9...11	21...25	70	
DC Control	Pick-up	[W]	700...850	1300...1550	2100	
	Hold-in	[W]	8...10	18...22	60	
Operating Times: Switching Delay						
AC	Making delay	[ms]	50...100			50...100
	Breaking delay	[ms]	20...50 ⁽¹⁾ /150...200/500...1000 ⁽²⁾			25...50
DC	Making delay	[ms]	50...100			50...100
	Breaking delay	[ms]	20...50 ⁽¹⁾ /150...200/500...1000 ⁽²⁾			25...50

(1) Accelerates

(2) Delays

Auxiliary Contacts

Cat. No.		100-G550...	100-G700...	100-G860...	100-G1000	100-G1200
Switching of AC Loads						
AC-1 I_{th}	at 40 °C	[A]	16			16
	at 60 °C	[A]	12			12
AC-15 at rated voltage	120V	[A]	6			6
	230V	[A]	3			3
	240V	[A]	3			3
	400V	[A]	2			2
	415V	[A]	2			2
	500V	[A]	1.5			1.5
	690V	[A]	1			1
Switching of DC Loads						
DC-13 control of electromagnets	2V DC	[A]	6			6
	48V DC	[A]	3			3
	110V DC	[A]	1			1
	220V DC	[A]	0.5			0.5
Back-up Fuse Short-circuit protection without contact welding per IEC60947-5						
Fuse gG	[A]	10			16	

General

Cat. No.		100-G550...	100-G700...	100-G860...	100-G1000	100-G1200
Rated Isolation Voltage U_i						
IEC, AS, BS, SEV, VDE, 0660	[V]	1,000			690	
UL, CSA	[V]	600			600	
Rated Impulse Voltage Withstand U_{imp}						
1minuteperIEC947-4	[KV]	8			2,5	
Rated Voltage-Main Control U_e						
AC, 50/60Hz	[V]	230, 240, 400, 415, 460, 500, 575, 690V			230, 240, 400, 415, 460, 500, 575, 690V	
DC		24, 48, 110, 220, 440V				
Operating Frequency for AC Loads, 50/60 Hz	[Hz]	180/hr. for 0.25 s start time-42/hr. for 1s start time				
Insulation Class of the Magnetic Coil		Class B per VDE 0660, table 22				
Rated frequency of the Coil		AC 50/60 Hz, DC				
Ambient Temperature						
Storage		-40 °C... + 80 °C				
Operation at rated current		-25 °C... 70 °C				
Climatic Withstand		Damp alternating conditions cyclical, per DIN 50016 and 40046, part 38, IEC 60068				
Altitude		2000 m above sea level, per IEC60947-1				
Type of Protection		IP00 IEC 60529/DIN 40050				

Standards Compliance and Certifications

100-G Contactors

Standards Compliance	Certifications
EN/IEC 60947-4-1	CE Marked
IEC 60947 Type "1" Coordination	cULus Listed (File No. E 3125, Guide NLDX, NLDX7)
CSA C22.2 No. 14	
UL 508	

Life-Load Curves

100-G550...100-G1200

Figure 27 - AC-3 Switching of Running Three-phase Motors, $U_e = 380...460V$ AC; AC-1 Non or Slightly Inductive Loads, Resistance Furnaces

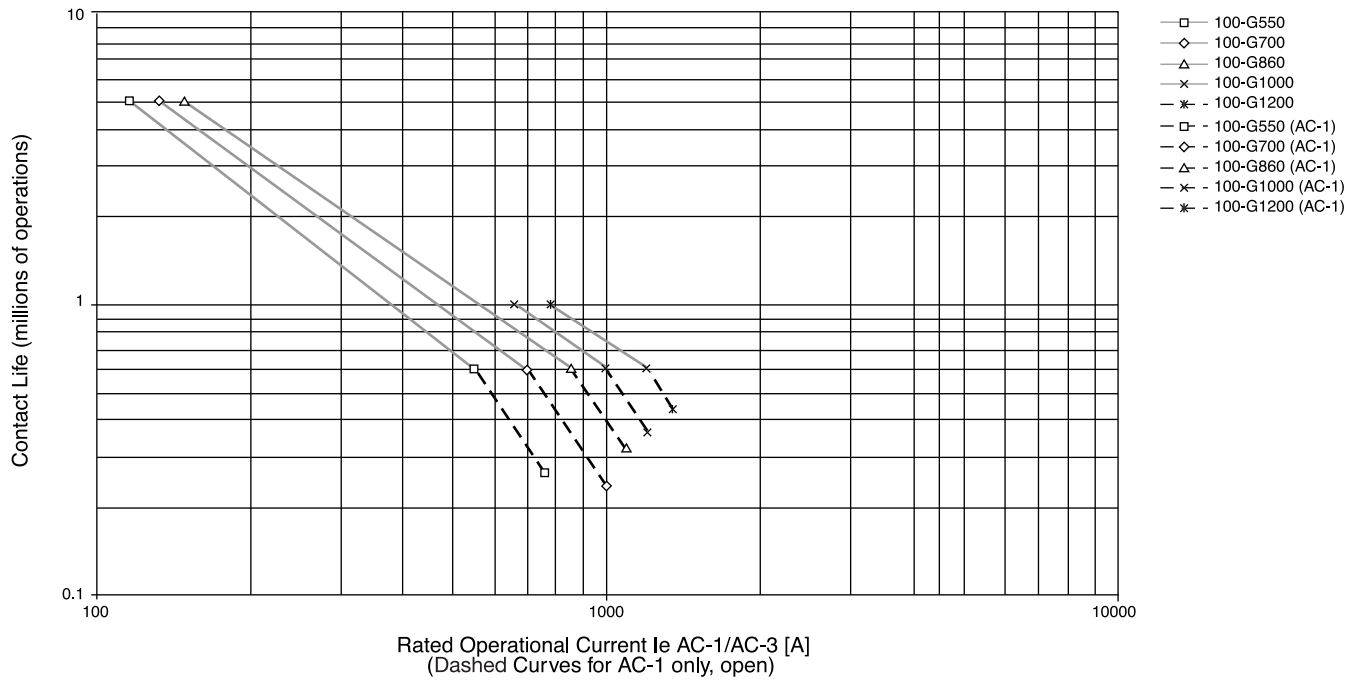

Figure 28 - AC-4 Jogging of Squirrel-cage Motors, $U_e = 380...460V AC$

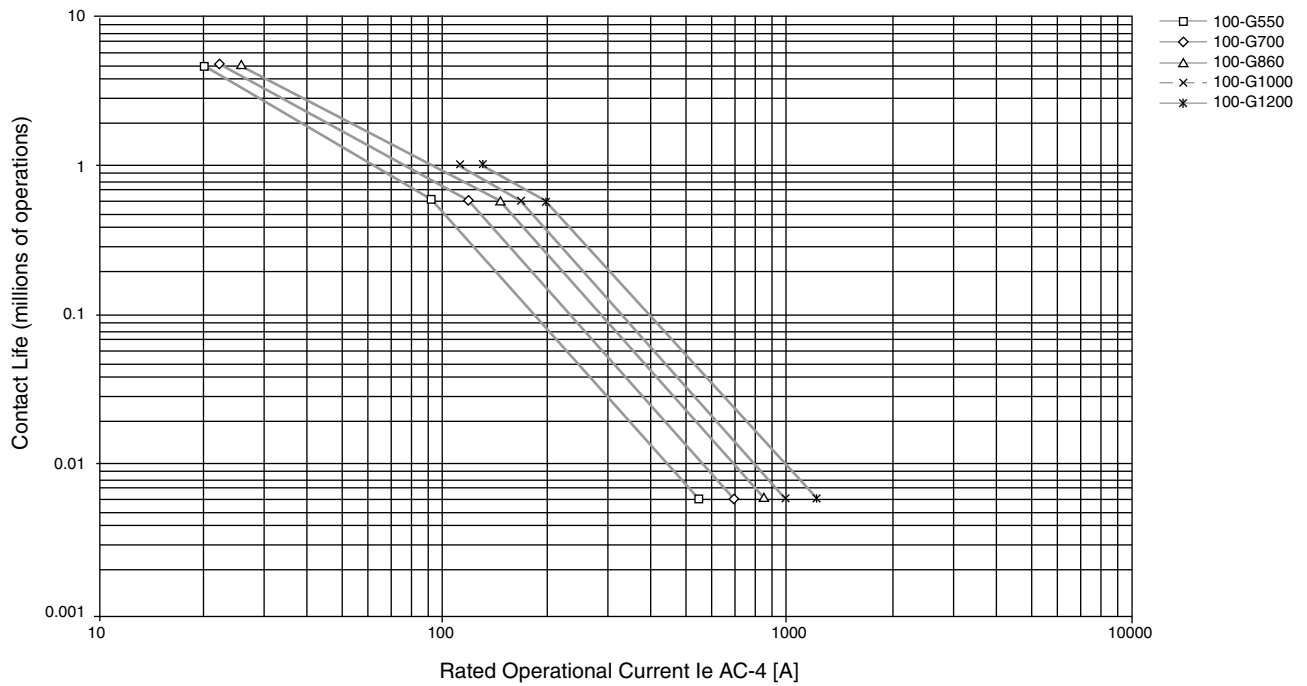
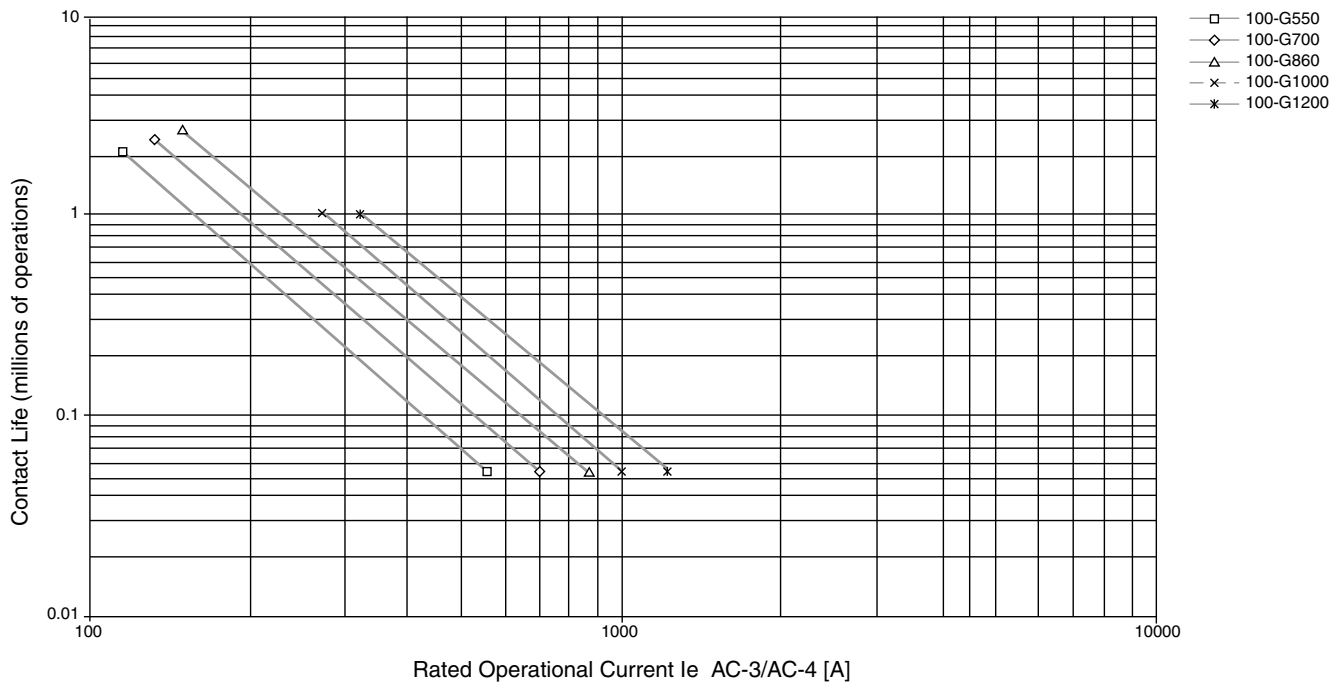

Figure 29 - AC-3 90% Switching of Running Motors, $U_e = 380...460V AC$; AC-4 10% Jogging



Permissible Switching Rate

100-G550...100-G1200

Figure 30 - Switching of Running Squirrel-cage Motors AC-3, $U_e = 380...460V$ AC; Starting Time $t_s = 0.25$ s, Relative Running Time 40%

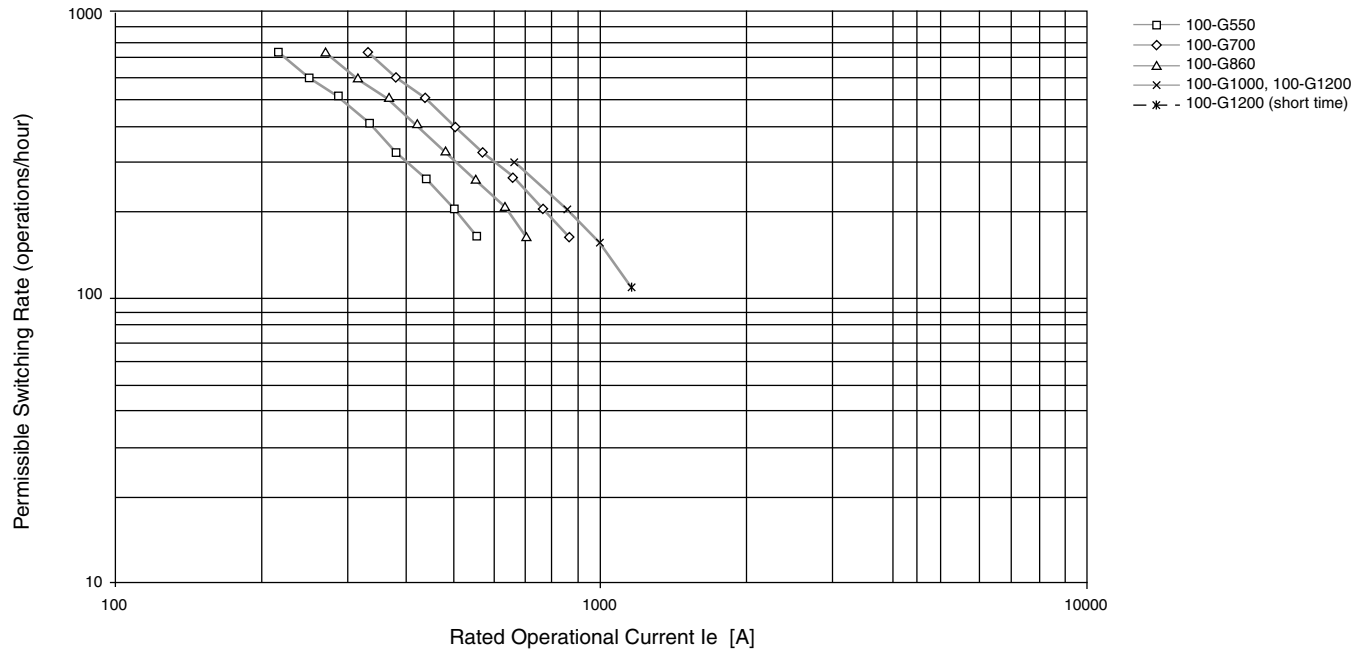

Figure 31 - Switching of Running Squirrel-cage Motors AC-3, $U_e = 380...460V$ AC; Starting Time $t_s = 1$ s, Relative Running Time 40%

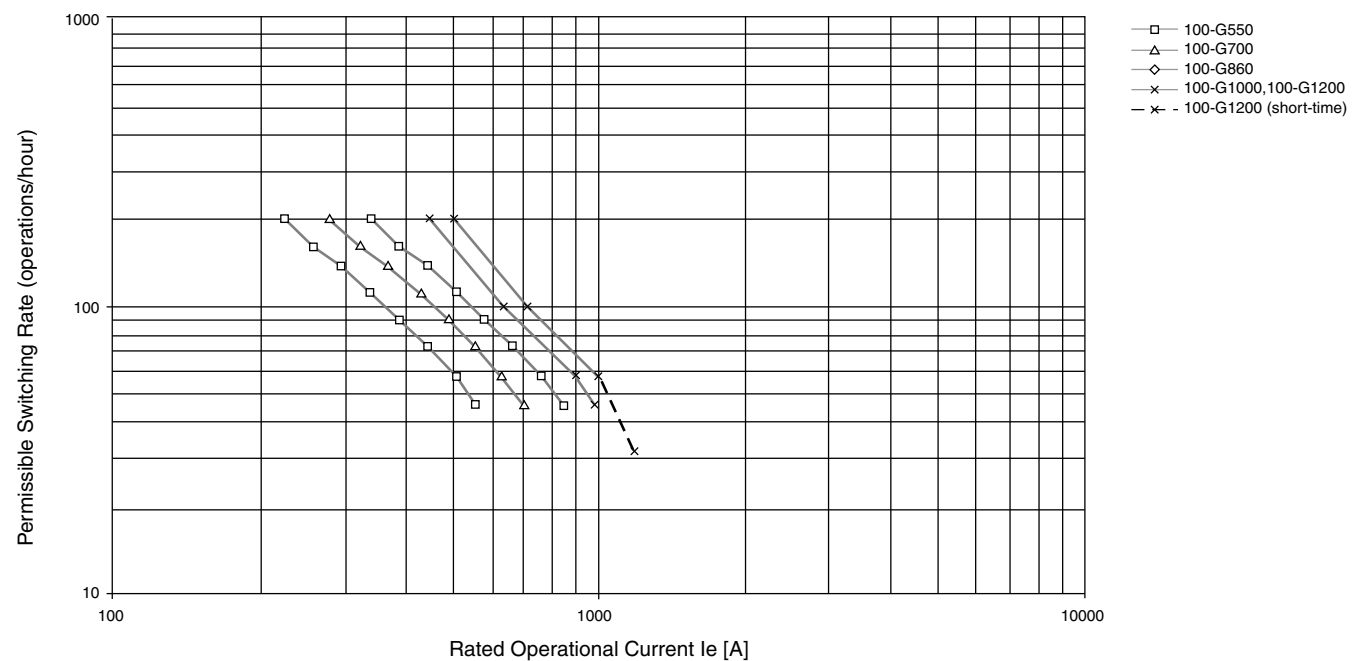
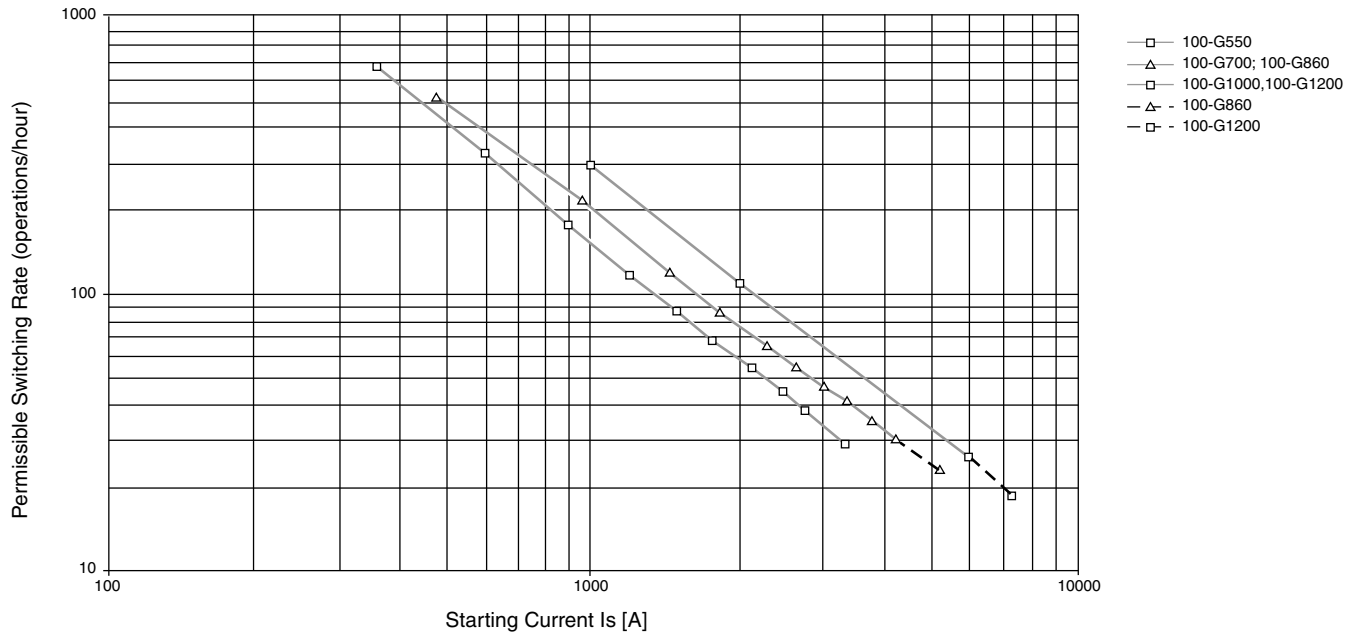

Figure 32 - Switching of Starting Motors (AC-2, and AC4) $U_z = 380 \dots 460V$ AC; Starting Time $t_{ed} = 1$ s, ($< t_s$)



Approximate Dimensions

Dimensions are shown in millimeters (inches). Dimensions are not intended for manufacturing purposes.

Figure 33 - Bulletin 100-G Contactors and Accessories

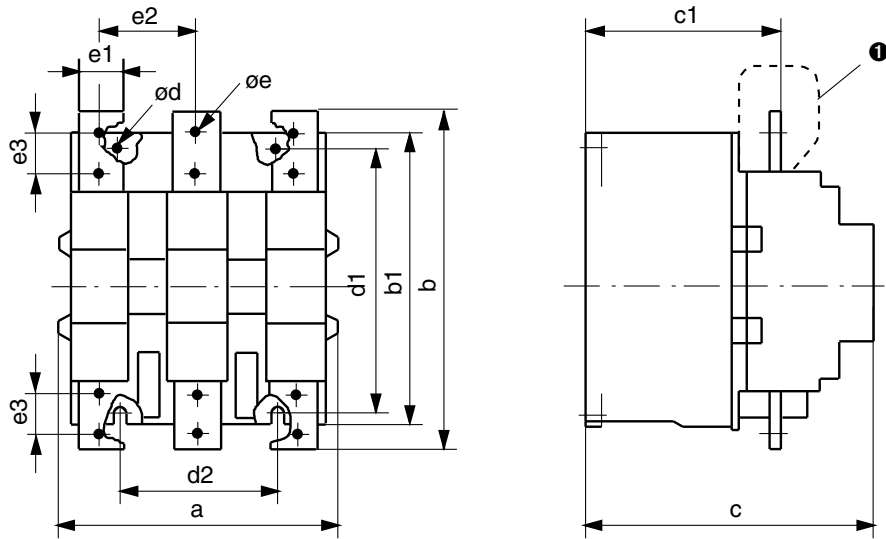

Figure 34 - Mounting Position

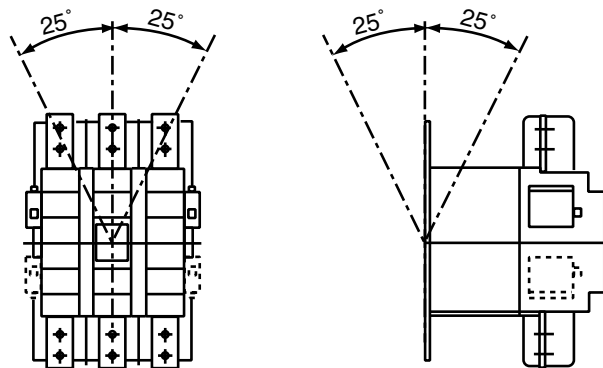

Table 12 - AC and DC Contactors

Cat. No.	a	b	b1	c	c1	Ø d	d1	d2	Ø e	e1	e2	e3
100-G550	220	258	228	225	164	9	220	110	12.5	40	79	—
100-G700	280	307	277	291	203	11	280	175	13	50	101	—
100-G860	280	361	325	291	203	11	280	175	15	50	101	—
100-G1000	334	490	434	345	231	13.5	380	120	2x13	50	100	40
100-G1200	334	490	434	345	231	13.5	380	120	2x13	60	100	40

Table 13 - Contactors with Accessories

Contactor with			mm
Auxiliary contact block			a
Mechanical Interlock	side by side	100-G550/100-G550	a+42+a
		100-G700, -860/100-G700, -860	a+32+a
		100-G1000, -1200/100-G1000, -1200	a+46+a
		100-G550/100-G700, -860	a+37+a
		100-G700, -860/100-G1000, -1200	a+73+a
	stacked vertically	100-G550/100-G550	b+56 + b
		100-G700, -860/100-G700, -860	b/2+380...480+b/2
		100-G1000, -1200/100-G1000, -1200	b+120...170+b
		100-G550/100-G700, -860	b/2+400+b/2
		100-G700, -860/100-G1000, -1200	b/2+570+b/2
4th add-on neutral switching pole	100-G550	a+74	
	100-G700, -860	a+68	
	100-G1000, -1200	a+76	
Mechanical latch	100-G550	b+59	
	100-G700	b+64	
	100-G860	b+37	

Important User Information

Read this document and the documents listed in the additional resources section about installation, configuration, and operation of this equipment before you install, configure, operate, or maintain this product. Users are required to familiarize themselves with installation and wiring instructions in addition to requirements of all applicable codes, laws, and standards.

Activities including installation, adjustments, putting into service, use, assembly, disassembly, and maintenance are required to be carried out by suitably trained personnel in accordance with applicable code of practice.

If this equipment is used in a manner not specified by the manufacturer, the protection provided by the equipment may be impaired.

In no event will Rockwell Automation, Inc. be responsible or liable for indirect or consequential damages resulting from the use or application of this equipment.

The examples and diagrams in this manual are included solely for illustrative purposes. Because of the many variables and requirements associated with any particular installation, Rockwell Automation, Inc. cannot assume responsibility or liability for actual use based on the examples and diagrams.

No patent liability is assumed by Rockwell Automation, Inc. with respect to use of information, circuits, equipment, or software described in this manual.

Reproduction of the contents of this manual, in whole or in part, without written permission of Rockwell Automation, Inc., is prohibited.

Documentation Feedback

Your comments will help us serve your documentation needs better. If you have any suggestions on how to improve this document, complete this form, publication [RA-DU002](#), available at <http://www.rockwellautomation.com/literature/>.

Allen-Bradley, Rockwell Software, Rockwell Automation, and LISTEN. THINK. SOLVE are trademarks of Rockwell Automation, Inc.
Trademarks not belonging to Rockwell Automation are property of their respective companies.

Rockwell Otomasyon Ticaret A.Ş., Kar Plaza İş Merkezi E Blok Kat:6 34752 İçerenköy, İstanbul, Tel: +90 (216) 5698400

www.rockwellautomation.com

Power, Control and Information Solutions Headquarters

Americas: Rockwell Automation, 1201 South Second Street, Milwaukee, WI 53204-2496 USA, Tel: (1) 414.382.2000, Fax: (1) 414.382.4444
Europe/Middle East/Africa: Rockwell Automation NV, Pegasus Park, De Kleetlaan 12a, 1831 Diegem, Belgium, Tel: (32) 2 663 0600, Fax: (32) 2 663 0640
Asia Pacific: Rockwell Automation, Level 14, Core F, Cyberport 3, 100 Cyberport Road, Hong Kong, Tel: (852) 2887 4788, Fax: (852) 2508 1846

Publication 100-TD013E-EN-P - June 2015

Supersedes Publication 100-TD013D-EN-P April 2015

Copyright © 2015 Rockwell Automation, Inc. All rights reserved. Printed in the U.S.A.