

# HF5 TRANSMITTER



## BENEFITS

- Measures relative humidity, temperature and dew point
- Absolute repeatability guaranteed
- Freely programmable and scalable analog outputs

## APPLICATIONS

- Heating, ventilation, air conditioning
- Food industry
- Pharmaceutical industry
- Printing and paper industries



### Proven housing

- Robust, industrial-quality housing
- Wall or duct mounting possible

### Power supply

- 15...40 VDC/12...28 VAC
- 9...36 VDC/7...24 VAC (galvanically isolated)
- 100...240 VAC (galvanically isolated)

### Outputs

- The 2 analog outputs are freely selectable and scalable
- **2-wire** (HF52), **3/4-wire** (HF53) and 3/4-wire (HF54, HF56 with galvanic isolation) versions available
- Optional digital outputs allow networking via RS-485, Ethernet and even wireless
- Combined digital and analog output signals allow simultaneous control and monitoring of a device by just one transmitter

### Flexible choice of probes

- Connection of a wide range of probes possible
- Connection of simulators facilitates process validation



# APPLICATIONS

## HF5 WALL VERSION

Use in  
technical rooms

HF52/53/54 series



HF53S/54S series



HF56 series



## HF5 DUCT VERSION

Use in  
ventilation shafts



# PROBES FOR HYGROFLEX TRANSMITTERS

## STANDARD CLIMATIC PROBE

Range of application: - 50...100 °C  
Variants: Plastic and stainless-steel versions



## INDUSTRIAL PROBES

Range of application: - 100...200 °C  
Material: Stainless steel



Order Code	Type	Accuracy @ 23 °C	Application Range	Sensor Element	Long-Term Stability
HC2A-IC	Industrial probe	±0.8 %RH ±0.1 K	-100...200 °C	HYGROMER HT-1	<1 %RH / year
HC2A-S	Standard probe, black				
HC2A-S3	Meteo probe, white				
HC2A-SM	Steel probe	±1.2 %RH ±0.1 K	-50...100 °C 0...100 %RH	HYGROMER HH-1	
HC2A-S-HH	Standard probes for harsh environments				
HC2A-SM-HH					

# TECHNICAL INFORMATION

## HF52/53/54 series

Wall version (W)

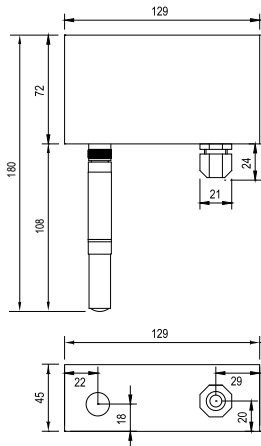

Duct version (D)

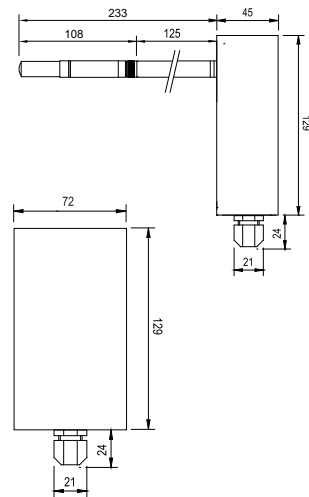

## HF56 series

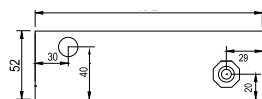
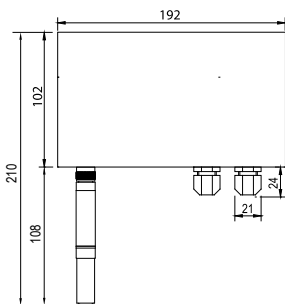

## HF53S/54S series

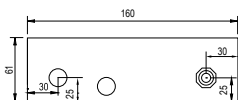
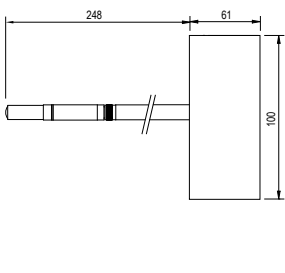
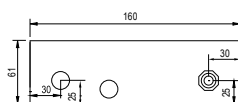
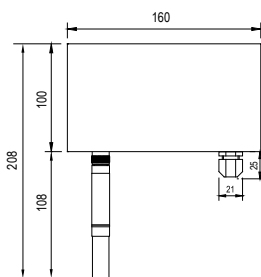

	HF52 2-wire	HF53/54/56 3/4-wire
Humidity probe	HygroClip2 probes, various types*	
Probe cable extension	Passive: max. 5 m, active: 100 m	
Accuracy at 23 ±5 °C	Probe dependent	
Response time τ 63	Probe dependent	
Initialization time	HF53/54/56 typically 3 s, HF52 typically 60 s	
Measurement range	Probe dependent	
Range of application electronics	HF53/54/56: -40...60 °C / 0...100%RH (-10...60 °C with LCD)	
Display type (option) (HF52: without backlight)	Graphic with backlight Display freely configurable	
Trend indicator	Yes	
Output signals (analog)	Freely scalable by user 0...1 V, 0...5 V, 0...10 V, 0(4)...20 mA	
Digital outputs (optional)	Ethernet (LAN, WLAN), USB, RS-485	
Power supply	HF52: 10...28 VDC: 10 V + (0.02 x load) HF53: 15...40 VDC/12...28 VAC HF54 with galvanic isolation: 9...36 VDC HF56 with galvanic isolation: 100...240 VAC	
Current consumption	HF52: max. 40 mA, others <100 mA, LAN option <300 mA	
Circuit type	HF52: 2 x 2 wires HF53/54/56: 3/4 wires	
Load per analog output	V-signal: ≥1 kΩ/V / mA-signal: ≤500 Ω	
Load compensation	Yes	
Firmware upgradable	Yes, via HW4 software	
Sensor diagnostics (drift, state)	Programmable. Default: Off	
Humidity adjustment	Keyboard/Software: multipoint (HF53/54/56)	
Temperature adjustment	Keyboard: 1-point Software: 2-point (HF53/54/56)	
External memory function for logging	Yes, 2000 data point memory	
Psychrometric calculations	All	
PC interface, UART	Yes, HW4-compatible	
Data processing via HW4	Graphics, statistics, analyses, qualification, etc.	
Housing material	ABS / Aluminum (HF5xxS)	
Cable connections	1 x M16 x 1.5, to terminals	
Standards	CE conformity 2014/30/EU	
Audit trail, electronic records	Conforms to FDA 21 CFR Part 11 and GAMP	
IP protection & fire protection class	IP65 / Corresponds to UL94-HB	

\* HF520 transmitters are not compatible with metal industrial probes

Subject to technical change without notice. Printing and other errors reserved.

59086E/2020-10