

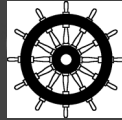

-power in control

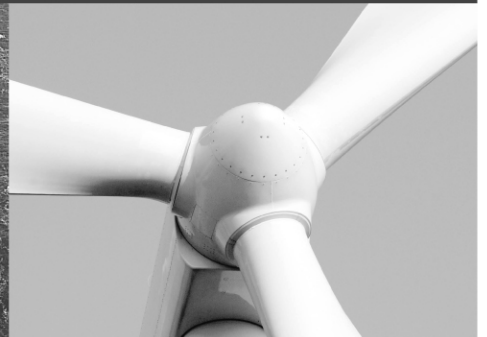

## Illuminated indicators, XL/BW/BRW-2 series DATA SHEET



### Linearity

- Class 0.5

### Scales

- Standard scale design
- Custom scale design

### Robust design

- Shock: 50 g 11 ms
- Vibration: 2.1 g

### Approval

- Major class type approvals, see [www.deif.com](http://www.deif.com) for certificates

### Housing

- Panel types (XL)
- Bridge wing types (BW and BRW-2)

### Illumination

- Direct pointer illumination (yellow/orange)
- Transillumination of the scale with white LEDs

### Pointers

- Standard pointer
- Rotating disc

### Analogue interface

- Single analogue input with several ranges
- Dual analogue input for direct connection to SIN/COS or dual linear transmitter

### CAN interface

- Dual CANopen communication line for redundancy, according to marine standard sCAN (DEIF single CAN)



DEIF A/S · Frisenborgvej 33 · DK-7800 Skive  
Tel.: +45 9614 9614 · Fax: +45 9614 9615  
[info@deif.com](mailto:info@deif.com) · [www.deif.com](http://www.deif.com)

Document no.: 4921250057U

## Technology

The patented x-coil technology is the core of this product series. The clear advantages of this indicator principle compared to the more fragile moving-coil system are e.g. superb accuracy (class 0.5), improved response time with practically no overshoot, excellent torque of the x-coil system, direct pointer illumination, connection to CANbus, improved shock resistance, more robust construction, 360 degrees pointer movement etc.

For supplying the built-in microprocessor, the XL/BW/BRW-2 indicators need connection to an external power supply.

## Housing

Do not use indicators with black scale base for outside applications, as the warranty may be lost. Refer to the User's Manual for further information.

### Panel types (XL)

The XL type is designed for panel mounting in standard cutout DIN holes. Since the frame sizes are not according to DIN norms, IP66 protection is possible without compromising the unique design of the indicator.

### Bridge wing types (BW and BRW-2)

Indicators for bridge wing mounting. These are basically XL indicators with an outside enclosure and with built-in dimmer. IP66 protection is standard.

## Interface

Due to the microprocessor-controlled x-coil technology, the indicators have a wide range of interfaces:

### Analogue interface

Both single and dual analogue signals are supported by the analogue interface. This enables the indicators to replace a number of existing products, e.g. all standard analogue ranges and special SIN/COS indicators.

### sCAN interface

A single line CANbus for direct connection of indicators to a CAN transmitter.

### Dual CANopen interface

CANopen interface with full redundancy from two galvanically separated CAN lines.

More detailed CAN information is available on [www.deif.com](http://www.deif.com) (CAN specification), and EDS file is available from the software download section.

## Illumination

Direct pointer illumination (black scales) is based on separate LEDs (yellow), and the scale is trans-illuminated using white LEDs. Black shadow pointer is used for white scale designs.

As an option, a rotating disc with illuminated symbol is available.

## Pointer deflection

The pointer is able to move 360 degrees (endlessly). Standard pointer movement is clockwise. Counter-clockwise movement is optional.

Pointer position is random until aux. supply is connected.

## Error functions

The indicators have two different error functions:

### Warning LED

The amber coloured warning LED is triangular and is placed in the lower right corner of the scale, except in XL72 where it is in the lower left corner.

### Pointer indication

Due to the possibility of 360 degrees pointer rotation, the unused scale part (typically the 240 to 0 degrees area) is used as an error indication field. Under certain conditions the pointer will move to this position:

- Out of range analogue input signal
- Missing CAN signal

More detailed information about error functionality is available on [www.deif.com](http://www.deif.com) (User's Manual).

## Customer configuration

The flexibility of the XL/BW/BRW-2 series requires the customer to make some selections for use when ordering the indicator. These selections determine how the indicator will appear at delivery. The table below will guide you through the configuration via the necessary selections.



Product configuration

Customer options		Note		
1. Housing	Panel types	Size:	<input type="checkbox"/> XL72	Please note recommended panel cutout on dimension pages!
			<input type="checkbox"/> XL96	
			<input type="checkbox"/> XL144	
			<input type="checkbox"/> XL192	
	Protection:	<input type="checkbox"/> IP52 (standard)		
		<input type="checkbox"/> IP66		
Bridge wing types	Type:	<input type="checkbox"/> BW144	IP66 (standard)	
		<input type="checkbox"/> BW192	IP66 (standard)	
		<input type="checkbox"/> BRW-2	IP66 (standard)	
		<input type="checkbox"/> BRW-2 without internal dimmer	IP66 (standard)	
2. Input	Analogue	Type:	<input type="checkbox"/> Single	Input 1 terminals used
			<input type="checkbox"/> Dual SIN/COS	Input 1: SIN. Input 2: COS <sup>1</sup>
		Range:	<input type="checkbox"/> 0 to 1 V	Load: 1 kOhm
			<input type="checkbox"/> 0 to 10 V	Load: 10 kOhm
			<input type="checkbox"/> -1 to 0 to 1 V	Load: 1 kOhm
			<input type="checkbox"/> -5 to 0 to 5 V	Load: 10 kOhm
			<input type="checkbox"/> -10 to 0 to 10 V	Load: 10 kOhm
			<input type="checkbox"/> 0 to 1 mA	Load: 1 kOhm
			<input type="checkbox"/> 0 to 20 mA	Load: 50 Ohm
			<input type="checkbox"/> 4 to 20 mA/20 to 4 mA	Load: 50 Ohm, 4 to 20 mA on input 1 and 20 to 4 mA on input 2
			<input type="checkbox"/> -0.5 to 0 to 0.5 mA	Load: 1 kOhm
			<input type="checkbox"/> -1 to 0 to 1 mA	Load: 1 kOhm
		<input type="checkbox"/> -10 to 0 to 10 mA	Load: 50 Ohm	
		<input type="checkbox"/> -20 to 0 to 20 mA	Load: 50 Ohm	
		<input type="checkbox"/> Others	Specify request (within limits, page 7)	
	CAN interface	<input type="checkbox"/> sCAN (DEIF single CAN):	Input type	<input type="checkbox"/> 12-bit encoder
				<input type="checkbox"/> 16-bit encoder
				<input type="checkbox"/> Absolute input (select the 3 values below) 1. Minimum value: _____ (e.g. -400) 2. Centre value: _____ (e.g. 0) 3. Maximum value: _____ (e.g. +400)
		Indicator type: (application)	<input type="checkbox"/> General (RPM, Rudder, Pressure, etc.) <input type="checkbox"/> Azimuth (360 degree) <input type="checkbox"/> Pitch	
			Source Node ID	____ (1-127) Specify number
	<input type="checkbox"/> Dual CANopen	Contact DEIF	Do not use this as spare part!	
3. Pointer	<input type="checkbox"/> Standard	Colour defined by scale design	White with yellow illumination (black scale) or black shadow without illumination (white scale)	
	<input type="checkbox"/> Rotating disc (Only on XL72/96 and XL/BW144 and only black disc/scale base)	<input type="checkbox"/> Standard (known)	Specify design number from standard scale design document	
		<input type="checkbox"/> Custom (new)	Specify design	
	Pointer position at electrical mid. of input	<input type="checkbox"/> Pointer at 12 o'clock	Electrical mid. examples: 4 to 20 mA => 12 mA -10 to 0 to 10 V => 0 V 0 to 10 V => 5 V	
		<input type="checkbox"/> Pointer at 3 o'clock		
		<input type="checkbox"/> Pointer at 6 o'clock		
<input type="checkbox"/> Pointer at 9 o'clock				
	<input type="checkbox"/> Others			
Deflection	<input type="checkbox"/> Standard	Positive input moves pointer clockwise (CW)	4 to 20 mA is always CW on input 1 and CCW on input 2 (20 to 4 mA)	
	<input type="checkbox"/> Reversed	Positive input moves pointer counterclockwise (CCW)		
4. Scale	Design	<input type="checkbox"/> Standard (known)	Specify design number from standard scale design document	
		<input type="checkbox"/> Custom (new)	Specify design	



1) Dual input cannot be used in combination with current loops. Due to the design of the input circuit, only one indicator can be used per output in this configuration. If multiple indicators are needed on the same output, please use the voltage versions.





**Standard indicators (RPM, Pitch, etc.)**

Input type:	Input 1:	Input 2:	Pointer position (scale):	STD design: EM=12 Pointer CW
4 to 20 mA	4 mA	-	-45	
0 to 10 V	0 V	-		
-10 to 0 to 10 V	-10 V	-		
4 to 20 mA	12 mA	-	0	
0 to 10 V	5 V	-		
-10 to 0 to 10 V	-10 V	-		
4 to 20 mA	20 mA	-	+45	
0 to 10 V	10 V	-		
-10 to 0 to 10 V	10 V	-		

**Rudder indicators**

When used in a system with TRI-2, XL must be CCW; or TRI-2 must be 20 to 4 mA and XL CW!

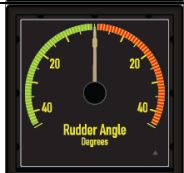

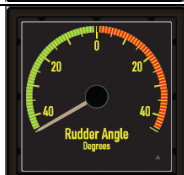



XL 4 to 20 mA can be changed from CW to CCW by the customer, and RT-2 can also be changed from CW to CCW during installation.

Input type:	Input 1:	Input 2:	Pointer position (scale):	FWD design: EM=6 Pointer CCW <sup>1</sup>	AFT design: EM=12 Pointer CCW <sup>1</sup>
4 to 20 mA	-	4 mA	-45		
0 to 10 V	0 V	-			
-10 to 0 to 10 V	-10 V	-			
4 to 20 mA	-	12 mA	0		
0 to 10 V	5 V	-			
-10 to 0 to 10 V	-10 V	-			
4 to 20 mA	-	20 mA	+45		
0 to 10 V	10 V	-			
-10 to 0 to 10 V	10 V	-			

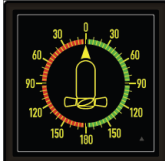
1: Make sure that the pointer rotation matches other indicators/transmitters in the system (TRI-2, RT-2, etc.).

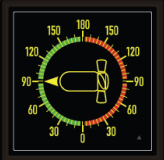
**XL azimuth standard indicators (EM = scale value zero)**

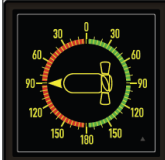
Analogue Single, FWD and AFT designs:

Input type:	Input 1:	Input 2:	Pointer position (scale):	FWD design: EM=12 <sup>2</sup> Pointer CW <sup>1</sup>	AFT design: EM=6 <sup>2</sup> Pointer CW <sup>1</sup>
4 to 20 mA	4 mA	-	0		
0 to 10 V	0 V	-			
-10 to 0 to 10 V	-10 V	-			
4 to 20 mA	8 mA	-	+90		
0 to 10 V	2.5 V	-			
-10 to 0 to 10 V	-5 V	-			
4 to 20 mA	12 mA	-	180		
0 to 10 V	5 V	-			
-10 to 0 to 10 V	0 V	-			
4 to 20 mA	16 mA	-	-90		
0 to 10 V	7.5 V	-			
-10 to 0 to 10 V	5 V	-			

- 1: Make sure that the pointer rotation matches other indicators/transmitters in the system (RTA-602, etc.).
- 2: EM can be changed 180 degrees (from 6 ->12 or 12 -> 6) by turning the rear side adjustment potentiometer A.

Analogue SIN/COS interface, FWD and AFT designs:

Input type:	Input 1 (SIN):	Input 2 (COS):	Pointer position (scale):	FWD design: EM=12 <sup>2</sup> Pointer CW <sup>1</sup>	AFT design: EM=6 <sup>2</sup> Pointer CW <sup>1</sup>
4 to 20 mA	12 mA	4 mA	0		
0 to 10 V	5 V	0 V	(A)		
-10 to 0 to 10 V	0 V	-10 V			
4 to 20 mA	4 mA	12 mA	+90		
0 to 10 V	0 V	5 V	(B)		
-10 to 0 to 10 V	-10 V	0 V			
4 to 20 mA	12 mA	20 mA	180		
0 to 10 V	5 V	10 V	(C)		
-10 to 0 to 10 V	0 V	10 V			
4 to 20 mA	20 mA	12 mA	-90		
0 to 10 V	10 V	5 V	(D)		
-10 to 0 to 10 V	10 V	0 V			

- 1: Make sure that the pointer rotation matches other indicators/transmitters in the system.
- 2: EM can be changed 180 degrees (from 6 ->12 or 12 -> 6) by turning the rear side adjustment potentiometer A.

Steering Angle Feedback signals

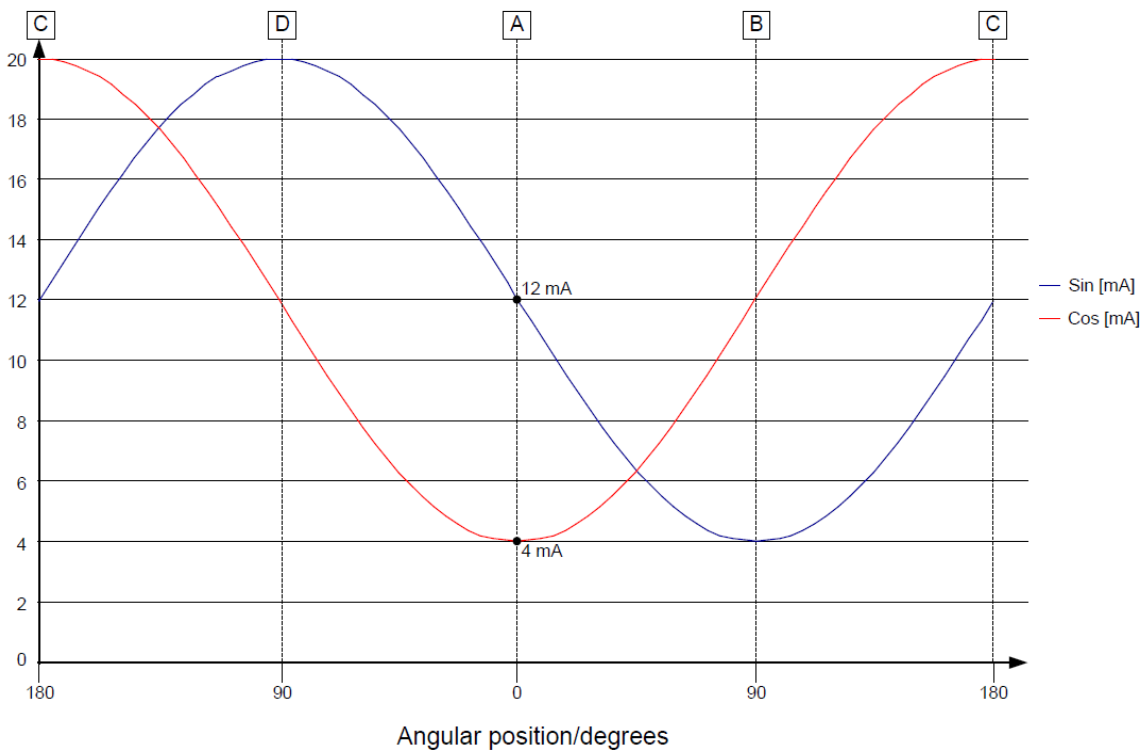

Scale design

Standard designs:

Please see the "XL/BW/BRW-2 standard scale designs" document on [www.deif.com](http://www.deif.com) for a complete list of standard designs.

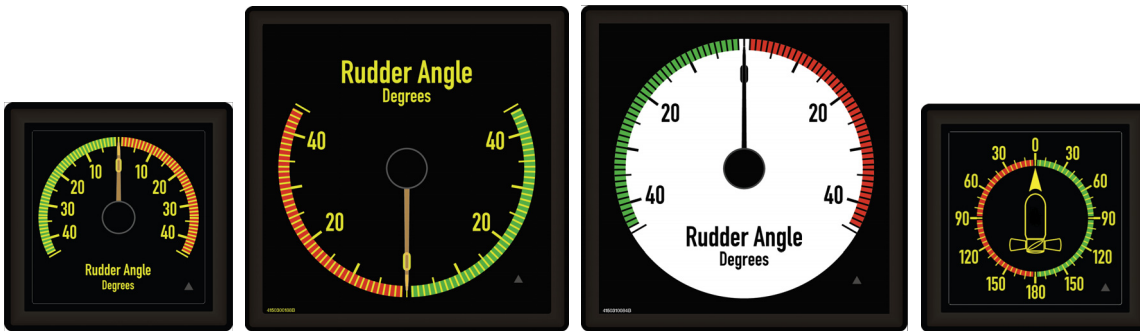

Above: A selection of standard designs

Custom designs:

If the standard designs do not meet your requirements, it is possible to specify a design according to custom specifications.

However, some limitations are still present due to product performance, automatic testing and approvals. Please contact DEIF for further information and design more samples. Also, the MED restrictions are focusing more and more on the specific design, so please keep that in mind when making your own design!

Examples of custom design scale plates:

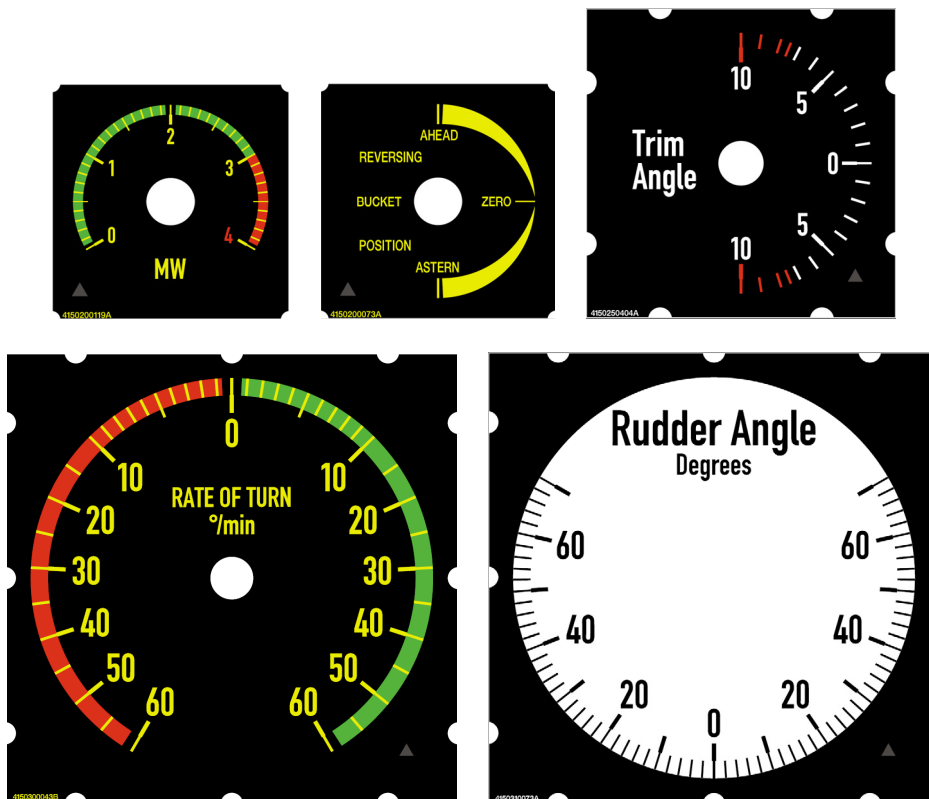

Terminals

**XL/BW analogue input version**

PIN no.	Function		Note
1	Supply voltage	0 V	Consumption max. 150 mA
2		24 V	
3	Analogue input	Input 1	Input 1 and GND used for single input. On 4 to 20 mA, input 1 is CW and input 2 CCW
4		GND	
5		Input 2	
6	Illumination	Illumination +	Dimmer input. Dimmer range 7 to 30 V <sub>dc</sub> Consumption max. 30 mA
7		Illumination GND	
8	-	NC	Not connected - can be used freely
A	Analogue adjustment	Max. adjustment	Max. and zero adjustment, sealed by label.  On 360 degree versions, A is EM selection and B is zero adjustment.
B		Zero adjustment	

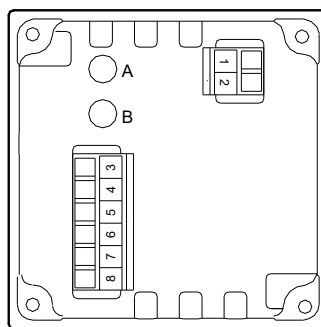

**XL/BW CANopen input version**

PIN no.	Function		Note
1	Supply voltage	0 V	Consumption max. 150 mA
2		24 V	
3	CAN connection	CAN 1 H input	CAN 1 line (sCAN line)
4		CAN 1 L input	
5		CAN 1 GND	
6		CAN 2 H input	CAN 2 line/or for external switch for calibrating sCAN (see user's manual)
7		CAN 2 L input	
8		CAN 2 GND	
9	Illumination analogue dimmer	NC	Dimmer input. Dimmer range 7 to 30 V <sub>dc</sub> Consumption max. 30 mA
10		Illumination GND	
11		Illumination +	

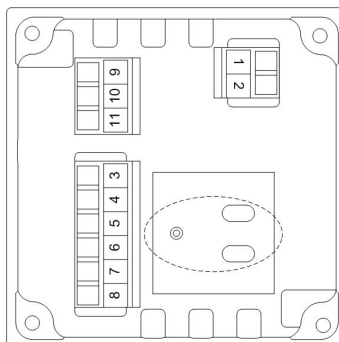

Use strips to terminate cable shields to metal termination plate (shown in the dashed circle) to avoid noise.



**BRW-2 analogue input PCB**

PIN no.	Function	Note
1	Supply voltage	0 V
2		24 V
3	Analogue input	Input 1
4		GND
5		Input 2
8		NC
9	Orange	X4 is connector to dimmer potentiometer. On versions without dimmer, this is for external dimmer connection (10 kOhm).
10	Brown	
11	Red	

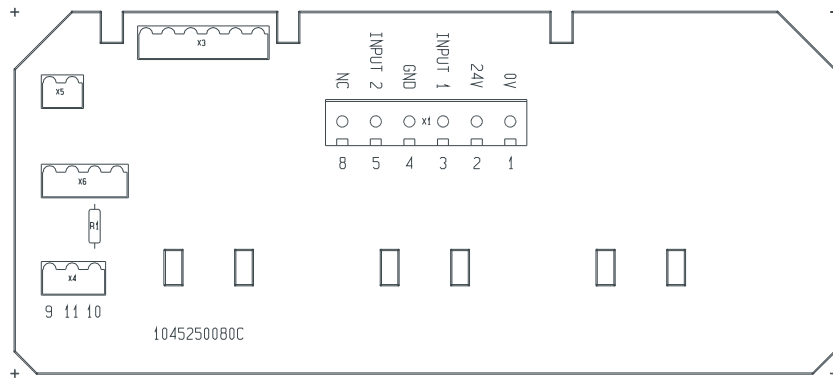

Connection interface board.

**BRW-2 CANopen input PCB**

PIN no.	Function	Note
-	Supply voltage	0 V
+		24 V
83	CAN connection	CAN 1 H input
84		CAN 1 L input
⊥		CAN 1 GND
93	CAN 2 connection	CAN 2 H input
91		CAN 2 L input
⊥		CAN 2 GND
9	Orange	X4 is connector to dimmer potentiometer. On versions without dimmer, this is for external dimmer connection (10 kOhm).
10	Brown	
11	Red	

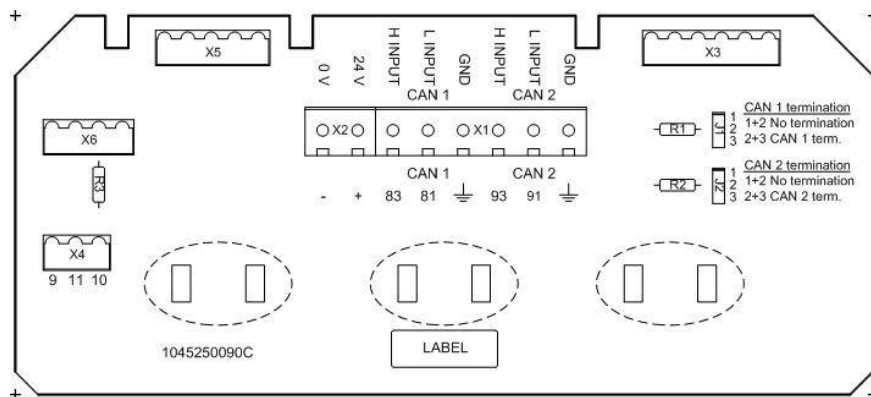

Use strips to terminate cable shields to PCB to avoid noise (see the dashed circles). Jumpers J1 and J2 are used as end resistors (terminations) of CAN 1 and CAN 2.

Technical specifications

Indicators are designed according to the standards below			Standards	
Accuracy	Class 0.5 (-10 to 15 to 30 to 55 °C) measured at 360 degrees deflection, corresponds to ±1.8 degree error		According to DEIF interpretation of IEC/EN 60051	
Response time	Maximum pointer speed is 90 degrees per sec. To prevent overshoot, the pointer is ramped up/down during movement			
Indicator frame sizes and panel cutout	Type:	Front size:	XL will typically fit DIN 43700 cutout, but DEIF recommends a bit larger cutout to better match IP66 gasket option!	
	XL72	77 × 77 mm		68.5 × 68.5 mm
	XL96	102 × 102 mm		92.5 × 92.5 mm
	XL144	148.5 × 148.5 mm		138.5 × 138.5 mm
	XL192	196 × 196 mm		186.5 × 186.5 mm
	For BW and BRW-2, see the dimensional drawing			
Power supply	24 V <sub>dc</sub> -25/+30% (18 to 24 to 31.2 V <sub>dc</sub> ) Reverse polarity protected Start-up minimum voltage: 9.6 V <sub>dc</sub>			
Illumination supply	7 to 30 V (max. 31.2 V <sub>dc</sub> )			
Connectors	Analogue and Dual CAN: Pluggable screw terminals: 0.2 to 2.5 mm <sup>2</sup> sCAN (DEIF single CAN): Pluggable dual spring terminals: 0.2 to 2.5 mm <sup>2</sup>			
Galvanic separation	600 V <sub>ac</sub> between the following groups: CAN: Aux. supply; CAN 1; CAN 2 Analogue: Aux. supply; Analogue inputs (common); Dimmer			
Scale	Base material: PMMA			
Pointer	Black scale: Transparent polycarbonate with white print and yellow illumination (588nm), or White scale: Transparent polycarbonate with black print (shadow)			
Window	3 mm polycarbonate with UV blocking		UL94 V0	
Disc	XL72	Ø 31 mm		
	XL96	Ø 47 mm		
	XL144	Ø 70.5 mm		
	Always black scale base			
Housing	XL/BW: ASA/PC LURAN-S (plastic) BRW-2: LURAN-S, colour code: RAL 7001		UL94 V0	
Mounting angle	The indicators can be mounted at any angle between 0 to 150 ° horizontal without this affecting the calibration		DIN 16257	
Compass safety distance	Steering compass: 0.60 m, stand-by/emergency compass: 0.40 m		IEC/EN 60945	
Measuring ranges	See standard ranges and load on page 3 Limits are ±1 to ±30 V <sub>dc</sub> and ±1 to ±25 mA <sub>dc</sub> Load special inputs: 1 kΩ/V on voltage input and 1 V on current input			
sCAN calibration	Minimum, zero and maximum scale values can be aligned to system needs and pointer deflection changed between CW and CCW		See the User's Manual for details	
Analogue adjustments	Adjustments on rear side: A: Max. adjustment ±20 % B: Zero adjustment ±10 % On 360 degree versions: A: EM selector (CW = standard, CCW = 180 degree change)			
Out of range (analogue)	When the input is 2 % (-2 to 102 % of F.S.) out of range, the pointer is moved to error position		See the User's Manual for details	
Protection (International protection rating)	XL standard: IP52 from front, mounted in panel, IP20 from rear (IP66 from front when recommended gasket + clamps are used) BW and BRW-2 standard: IP66		IEC/EN 60529	
Climate	Class H S E, short term condensing allowed		DIN 40040	
	Max. 95 % RH: Max. 30 days per year Max. 85 % RH: Remaining days Max. 75 % RH: Average per year			
Temperature	Operating: -25 to 70 °C Storage: -40 to 80 °C		IEC/EN 60068-2-1 Cold IEC/EN 60068-2-1 Dry heat	
	Influence: Max. ±1.5 % within -15 to 55 °C		IEC/EN 60051	
Panel influence	The accuracy is affected neither by the material nor by the thickness of the panel		IEC/EN 60051	
Panel thickness	Max. 18 mm (on XL versions, DIN rear mounted)			

**Technical specifications, continued**

<b>Indicators are designed according to the standards below</b>		<b>Standards</b>
Mechanical shock test	18 × 50 g half sine (11 ms)	IEC 60068-2-27
Vibration test	3 to 13.2 Hz: 2 mm (peak-peak) 13.2 to 100 Hz: 0.7 g	EN 60945 DNV Class A
	3 to 13.2 Hz: 6 mm (peak-peak) 13.2 to 50 Hz: 2.1 g	DNV Class C
Safety	300 V – CAT. III. Pollution deg. 2	EN 61010-1
Consumption (analogue)	Aux. supply: 65 to 75 mA/24 V <sub>dc</sub> Illum. supply: 15 mA/24 V <sub>dc</sub> (XL72/96), 20 mA/24 V <sub>dc</sub> (XL144/192)	
Consumption (CAN) including illumination	100...130 mA/24 V <sub>dc</sub>	
EMC	CE-marked for industrial environment	EN 61000-6-V2/4 and EN 60945

Dimensions in mm

**XL72**

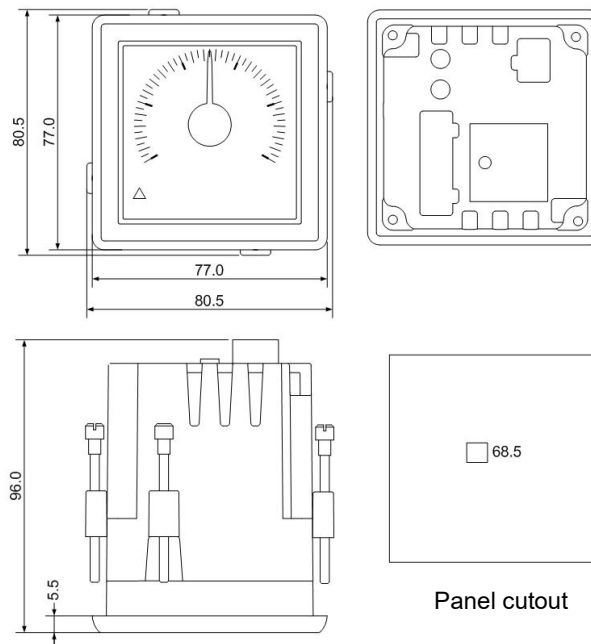

Weight: Approx. 240 g

**XL96**

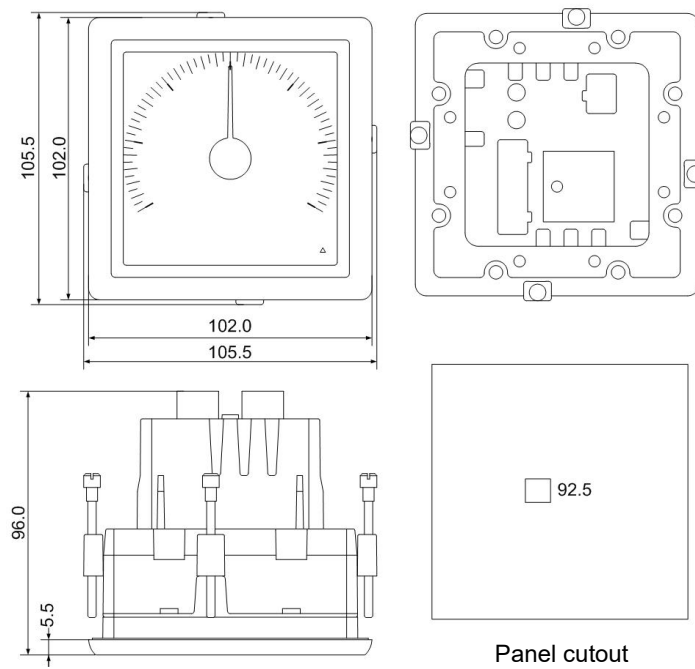

Weight: Approx. 330 g

**XL144**

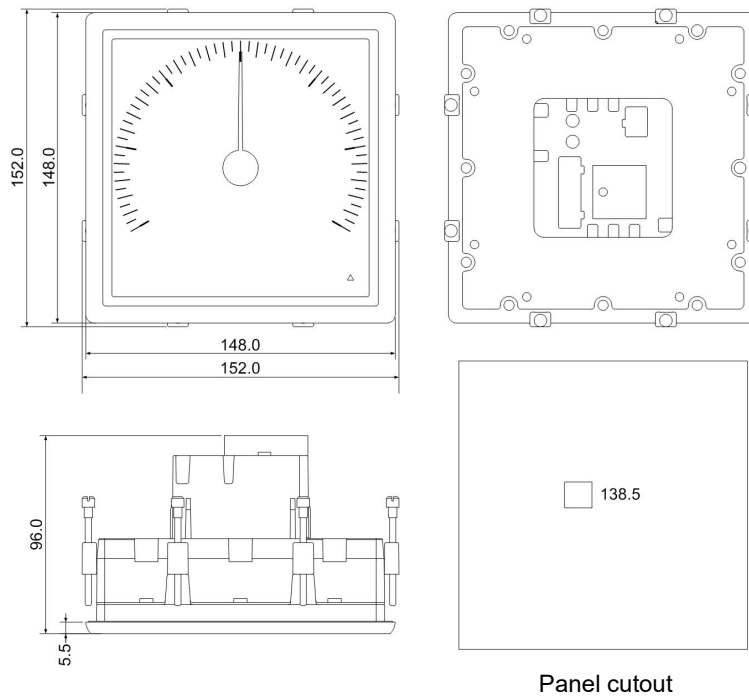

Weight: Approx. 550 g

**XL192**

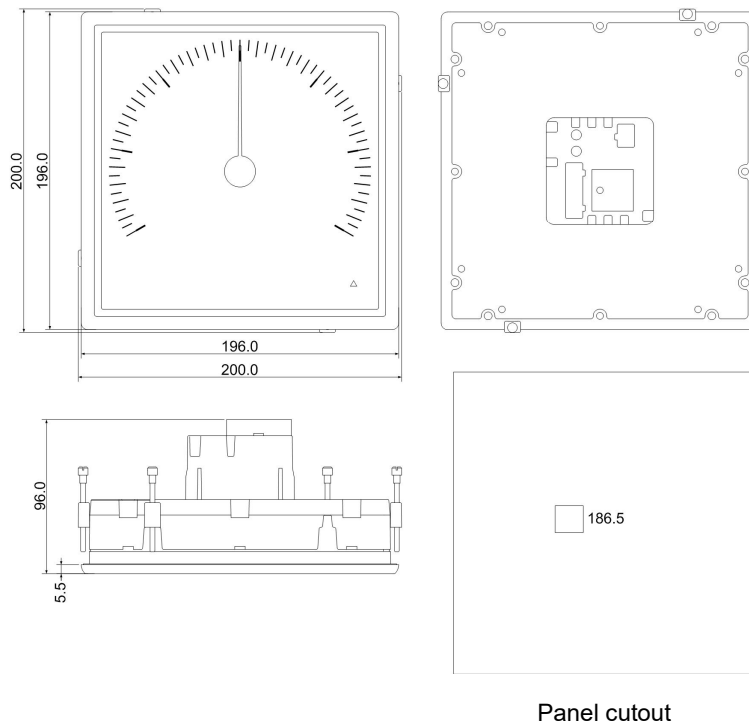

Weight: Approx. 810 g

**BW144**

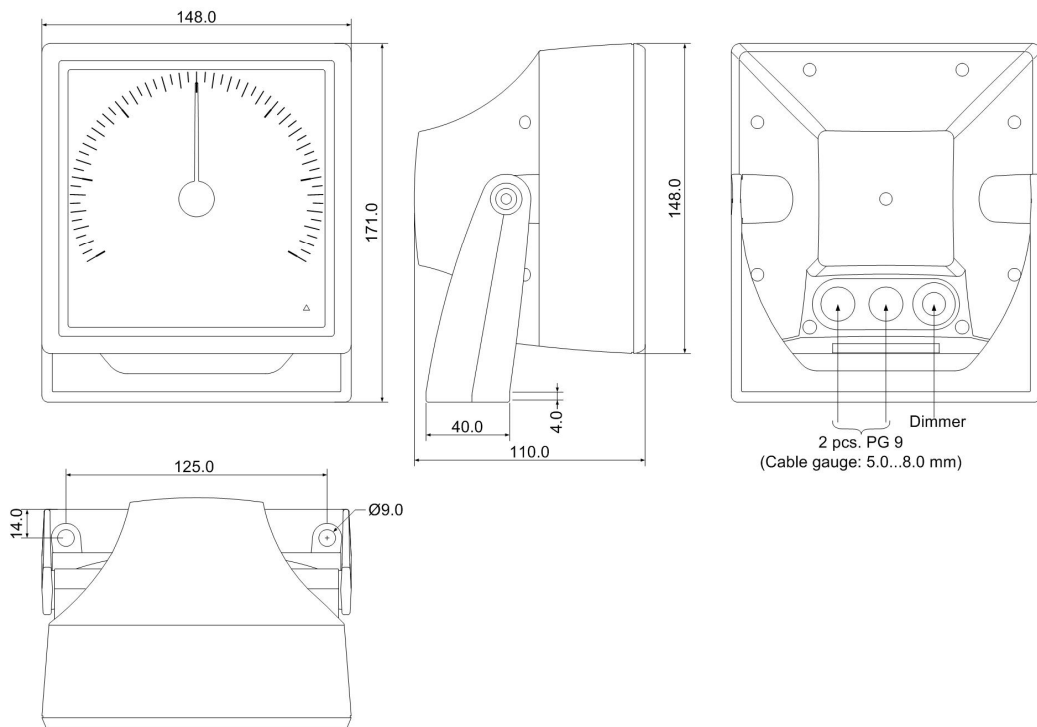

Weight: Approx. 990 g

**BW192**

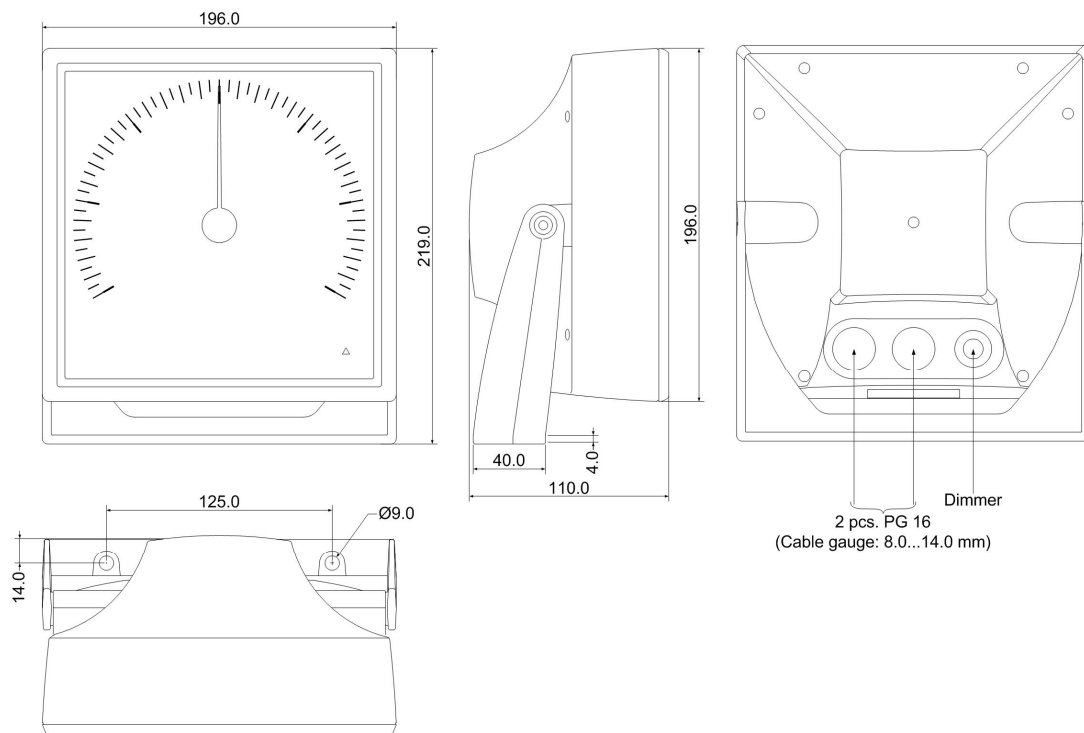

Weight: Approx. 1170 g

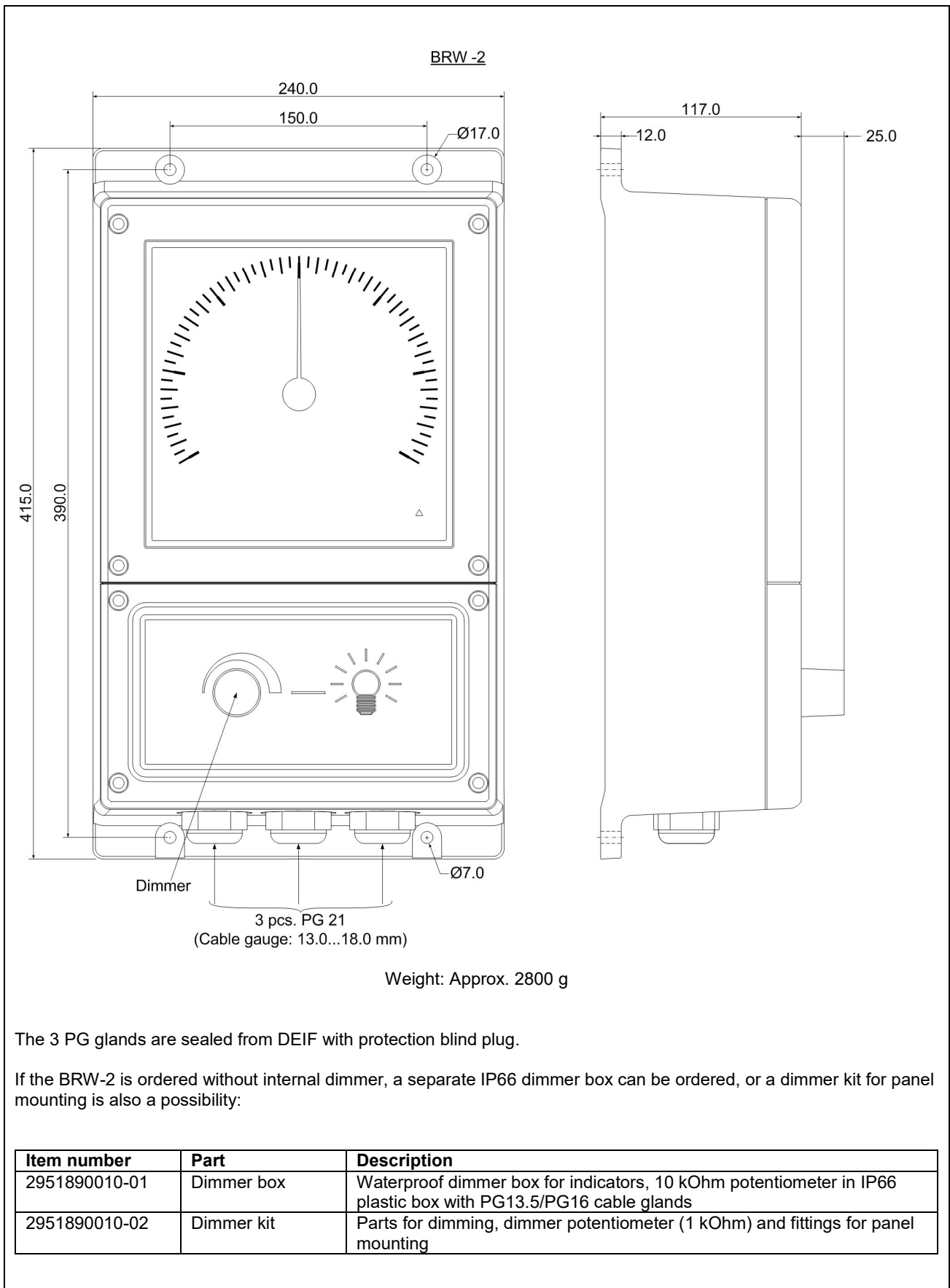

**Order specifications**

**Manual product configuration:**

*Use data from the configuration form on page 3.*



*If a required standard design is not found, please prepare drafts of preferred custom scale design, e.g. with reference to existing designs. At request DEIF provides scale designs for inspiration. The customer always approves the final scale design.*

**Example of order specification for an XL96 rudder angle indicator with a black base scale (-45 to 0 to 45 degrees rudder angle):**



1. Housing:	Panel type XL96, protection IP52 (standard)
2. Input:	Analogue, single, -10 to 0 to 10 V
3. Pointer:	Standard
4. Scale:	Standard, no.: 4150250357

Due to our continuous development we reserve the right to supply equipment which may vary from the described.



**DEIF A/S, Frisenborgvej 33**  
DK-7800 Skive, Denmark

Tel.: +45 9614 9614, Fax: +45 9614 9615  
E-mail: [deif@deif.com](mailto:deif@deif.com), URL: [www.deif.com](http://www.deif.com)

