

Industriefunkuhren



Technical Manual

System 6844 and 6844RC
(GPS and Sub-Master)

For Housing Versions
1U / 3U / Table / Wall

ENGLISH

Version: 06.01 – 20.10.2015

Valid for System 6844(RC) with FIRMWARE Version: **06.xx**

Version number (Firmware / Manual)

THE FIRST TWO DIGITS OF THE VERSION NUMBER OF THE TECHNICAL MANUAL AND THE FIRST TWO DIGITS OF THE FIRMWARE VERSION MUST **COMPLY WITH EACH OTHER**. THEY INDICATE THE FUNCTIONAL CORRELATION BETWEEN DEVICE AND TECHNICAL MANUAL.

THE DIGITS AFTER THE POINT IN THE VERSION NUMBER INDICATE CORRECTIONS IN THE FIRMWARE / MANUAL THAT ARE OF **NO** SIGNIFICANCE FOR THE FUNCTION.

Downloading Technical Manuals

All current manuals of our products are available free of charge via our homepage on the Internet.

Homepage: <http://www.hopf.com>

E-mail: info@hopf.com

Symbols and Characters



Operational Reliability

Disregard may cause damages to persons or material.



Functionality

Disregard may impact function of system/device.



Information

Notes and Information.



Safety regulations

The safety regulations and observance of the technical data serve to ensure trouble-free operation of the device and protection of persons and material. It is therefore of utmost importance to observe and compliance with these regulations.

If these are not complied with, then no claims may be made under the terms of the warranty. No liability will be assumed for any ensuing damage.



Safety of the device

This device has been manufactured in accordance with the latest technological standards and approved safety regulations

The device should only be put into operation by trained and qualified staff. Care must be taken that all cable connections are laid and fixed in position correctly. The device should only be operated with the voltage supply indicated on the identification label.

The device should only be operated by qualified staff or employees who have received specific instruction.

If a device must be opened for repair, this should only be carried out by employees with appropriate qualifications or by **hopf** Elektronik GmbH.

Before a device is opened or a fuse is changed all power supplies must be disconnected.

If there are reasons to believe that the operational safety can no longer be guaranteed the device must be taken out of service and labelled accordingly.

The safety may be impaired when the device does not operate properly or if it is obviously damaged.

CE-Conformity



This device fulfils the requirements of the EU directive 2004/108/EG "Electromagnetic compatibility" and 2006/95/EG "Low voltage equipment".

Therefore the device bears the CE identification marking
(CE = Communautés Européennes = European communities)

The CE indicates to the controlling bodies that the product complies with the requirements of the EU directive - especially with regard to protection of health and safety for the operator and the user - and may be released for sale within the common markets.

Contents	Page
1 Description of System 6844 and 6844RC	11
1.1 Difference between Systems 6844 and 6844RC	13
1.2 Structure of Housing Options.....	14
1.2.1 Differences between the Housing Options	14
1.2.2 System Design 6844(RC) in 19 inch Rack 3U/42HP and 3U/84HP	15
1.2.2.1 19 Inch Rack 3U/42HP and 3U/84HP	17
1.2.2.2 Display and Keypad.....	18
1.2.2.3 System-Bus 6000	18
1.2.2.4 Slots for Function Boards.....	18
1.2.3 System Design 6844(RC) in 19 inch Rack 1U/84HP (Slim Line)	19
1.2.3.1 19 Inch Rack 1U/84HP	20
1.2.3.2 Display.....	20
1.2.3.3 Keypad.....	20
1.2.3.4 Status LEDs.....	21
1.2.3.5 System-Bus 6000	21
1.2.3.6 Function Board Slots	22
1.2.3.7 Temperature-controlled Forced Ventilation.....	22
1.2.4 System Design 6844(RC) in ½ 19 inch Table Top Housing 3U/42HP	23
1.2.4.1 ½ 19 Inch Table Top Housing 3U/42HP	24
1.2.5 System Design 6844(RC) in ½ 19 inch Wall Housing 3U/42HP	24
1.2.5.1 ½ 19 Inch Wall Housing 3U/42HP	25
1.2.5.2 Slot for a Function Board	25
1.3 Quick Install.....	26
2 System 6844(RC) Synchronization	27
2.1 Summary / Synchronization Source Settings	27
2.1.1 Synchronisation via GPS	27
2.1.2 Synchronization via Serial Interface.....	28
2.1.3 Synchronisation via Serial Interface with High-Accurate PPS	28
2.1.4 Special Sync. via serial interface with LOCAL time (FE1000)	29
2.1.5 Special Sync. via serial interface with UTC time (FE1000)	29
2.1.6 Synchronization via DCF77 Pulse - CET / WORLDWIDE	29
2.1.6.1 Operation in the CET Time Zone (Europe)	30
2.1.6.2 Operation in a different Time Zone (Worldwide)	30
3 Installation	31
3.1 System 6844(RC) in 3U / Table-Top / Wall - Housing	31
3.1.1 Installation of the 19 Inch 3U Rack	31
3.1.2 Installing the Table-Top Housing	31
3.1.3 Mounting the Wall Housing	32
3.1.4 Earthing.....	32
3.1.5 AC Power Supply	32
3.1.6 Safety and Warning Instructions	32
3.1.6.1 Power Supply Unit Specifications	33
3.1.6.2 Fusing.....	33
3.1.7 DC Power Supply (Option).....	33
3.1.7.1 Power Supply Unit Specifications	34
3.1.7.2 Fusing.....	34
3.1.8 Synchronization Source Connection	34
3.1.8.1 GPS Antenna Equipment.....	34
3.1.8.2 Serial String	34
3.1.8.3 PPS (Pulse per second).....	34
3.1.8.4 DCF77 Pulse	34
3.1.9 COM0 / COM1 Serial Interfaces Connection	35
3.1.10 DCF77 Antenna Simulation (77.5kHz) Connection	35
3.1.11 Function Boards Connection / Input- and Output Modules.....	35
3.2 System 6844(RC) in 1U Slim Line Housing	36

3.2.1	Installation of the 19 Inch Rack.....	36
3.2.2	Earthing.....	36
3.2.3	AC Power Supply.....	36
3.2.3.1	Safety and Warning Instructions.....	37
3.2.3.2	Power Supply Unit Specifications.....	37
3.2.3.3	Fusing.....	37
3.2.4	DC Power Supply (Option).....	38
3.2.4.1	Power Supply Unit Specifications.....	38
3.2.4.2	Fusing.....	38
3.2.4.3	Reverse Voltage Protection.....	38
3.2.5	Synchronization Source Connection.....	39
3.2.5.1	GPS Antenna Equipment.....	39
3.2.5.2	Serial String.....	39
3.2.5.3	PPS (Pulse per second).....	39
3.2.5.4	DCF77 Pulse.....	39
3.2.6	COM0 / COM1 Serial Interfaces Connection.....	40
3.2.7	Error Relays Connection.....	40
3.2.8	DCF77 Antenna Simulation (77.5kHz) Connection.....	40
3.2.9	Function Boards Connection / Input- and Output Modules.....	40
4	Commissioning.....	41
4.1	General Procedure.....	41
4.2	Switching on the Operating Power Supply.....	41
4.3	Display after System Start/Reset (Firmware).....	42
4.3.1	Standard Display without Valid Time.....	42
4.3.2	Standard Display with Valid Time.....	42
4.3.3	Standard Display with Valid Time and Active ERROR-Byte.....	43
4.4	Keypad Functions.....	44
4.4.1	Keypad Layout.....	44
4.4.2	Key Assignment.....	44
4.4.3	Keypad Inputs / Main Menu Activation.....	45
4.5	Initialization.....	45
5	System Parameterization and Operation.....	46
5.1	Menu Structure.....	46
5.2	SET Menu - Basic Settings System 6844(RC).....	48
5.2.1	Fail-safe Storage of Data Entries.....	48
5.2.2	Input Time / Date.....	48
5.2.3	Input Local Time to UTC Time Offset (Time Zone).....	49
5.2.4	Input Daylight Saving Time (DST) Changeover.....	50
5.2.5	Input Position (GPS only).....	51
5.2.6	Input SyncOFF Timer - Delayed Change of Sync.-Status.....	52
5.2.7	Input Serial Interface Parameters.....	53
5.2.7.1	Selection Frames for Parameters of Serial Interface COM0.....	53
5.2.7.2	Selection Frames for Parameters of Serial Interface COM1.....	54
5.2.8	Input LAN Board Parameters (Option).....	54
5.2.8.1	Selection Frames for LAN Board 1 Parameters.....	54
5.2.8.2	Selection Frames for LAN Board 2 Parameters.....	55
5.2.8.3	Selection Frame Parameters of the LAN Management Board/Module (System 6844RC only).....	55
5.2.9	Input Frequency Output (Option).....	56
5.2.10	Input Status and Pulse Output.....	57
5.2.11	Selection of the Time Base for the LCD-Display.....	58
5.2.12	Selection of the Language for the Time Display on the LCD-Display.....	58
5.2.13	Input SYSTEM-Byte.....	59
5.2.13.1	Service Function for the GPS-Module-Update (via COM0) – Bit 6.....	59
5.2.13.2	Test mode - Simulation system status "synchronous - R" – Bit 5.....	60
5.2.13.3	Synchronization Mode (Sync.-Mode) – Bit 0-2.....	61
5.2.14	Keyword Function for Keypad.....	62

5.3	SHOW Menu - Display of the System 6844(RC) Base Settings.....	63
5.3.1	ERROR-Byte 1.....	64
5.3.2	ERROR-Byte 2.....	67
5.3.3	Satellite Values (GPS only).....	68
5.3.4	Position (GPS only).....	70
5.3.5	Time Offset (Time Zone).....	70
5.3.6	Daylight Saving Time (DST) Changeover.....	70
5.3.7	SyncOFF Timer - Delayed Change of Sync. Status.....	71
5.3.8	Serial Interface Parameters.....	72
5.3.8.1	Display Frames for the COM0 Serial Interface Parameters.....	72
5.3.8.2	Display Frames for the COM1 Serial Interface Parameters.....	72
5.3.9	LAN Board Parameters.....	73
5.3.9.1	Display Frames for LAN Board 1 Parameters.....	73
5.3.9.2	Display Frames for LAN Board 2 Parameters.....	73
5.3.9.3	Display Frames for LAN Management Board Parameters (System 6844RC only).....	74
5.3.10	Frequency Output (Option).....	75
5.3.11	Status and Pulse Output.....	75
5.3.12	SYSTEM-Byte.....	75
5.3.13	ADD.Outputs (Digital I/O).....	76
5.3.14	ADD.Inputs (Digital I/O).....	76
5.4	S.CLOCK Menu - Control of Slave Clocks with Function Board 7406.....	77
5.5	INI Menu - System 6844(RC) Extended Settings/Functions.....	77
5.5.1	Display the Firmware Version of Board 6844(RC).....	77
5.5.2	Display the PCID (Product Config ID) of Board 6844(RC).....	77
5.5.3	3D / Position-fix GPS Reception a. Synchronization Mode (GPS only).....	78
5.5.4	DCF77 Pulse (1Hz) / DCF77 Antenna Simulation (77.5kHz).....	79
5.5.4.1	Signal DCF77.SYS / DCF77 Antenna Simulation (77.5kHz).....	79
5.5.4.1.1	Display and Set the DCF77.SYS Configuration.....	79
5.5.4.1.2	Activation of the output DCF77 antenna simulation (77.5kHz).....	79
5.5.4.1.3	Display and Set DCF77.SYS TimeOFF.....	80
5.5.4.2	Signal DCF77.ADD (Option).....	80
5.5.4.2.1	Display and Set DCF77.ADD Configuration.....	80
5.5.4.2.2	Display and Set DCF77.ADD TimeOFF.....	80
5.5.5	IRIG-B (Digital) Output.....	81
5.5.5.1	IRIG Time Code, Structure and Timing Diagram.....	81
5.5.5.1.1	IRIG-Bxxx Format Classes in accordance with IRIG Standard 200-04.....	82
5.5.5.1.2	IEEE C37.188 (IEEE 1344).....	82
5.5.5.1.3	AFNOR NFS 87-500.....	82
5.5.5.2	Display and Set IRIG-B.(1) Configuration.....	83
5.5.5.3	Display and Set IRIG-B.(1) TimeOFF.....	83
5.5.5.4	IRIG-B.(2) Configuration/TimeOFF (Option).....	84
5.5.6	Activate LAN Management Board (Board 6844RC only).....	84
5.5.7	Trigger Reset / Default.....	85
5.5.7.1	Software-Reset (Control Board 6844(RC) only).....	85
5.5.7.2	Hardware-Reset (Complete System).....	85
5.5.7.3	Trigger the GPS Receiver Default (GPS only).....	85
5.5.7.4	Factory Default (Control Board 6844(RC) only).....	85
6	COM0 / COM1 Serial Interfaces.....	86
6.1	Configuration of the Serial Interfaces / Pulse Output.....	86
6.1.1	Serial Transmission Parameters.....	86
6.1.2	Configuration of the Data String (Mode Byte).....	88
6.1.2.1	Mode Byte 1 / Bit7 - Local Time or UTC in the Serial Output.....	89
6.1.2.2	Mode Byte 1 / Bit 6 - Serial Output Second Forerun.....	89
6.1.2.3	Mode Byte 1 / Bit 5 - Bit 5 currently no function.....	89
6.1.2.4	Mode Byte 1 / Bit 4 - Last Control Character at Second Change (On-Time Mark).....	89
6.1.2.5	Mode Byte 1 / Bit 3 - Reverse Control Characters CR and LF.....	89
6.1.2.6	Mode Byte 1 / Bit 2 - Delayed Transmission.....	89
6.1.2.7	Mode Byte 1 / Bit1-Bit0 - Data String Transmission Point of Time.....	90
6.1.2.8	Mode Byte 2 / Bit7: Output Mode DATA STRING / PULSES.....	90
6.1.2.9	Mode Byte 2 / Bit6-Bit0 - Data String Selection.....	90

6.1.2.10 Mode Byte 2 / Bit6-Bit0: Pulse Selection	91
6.1.2.11 Mode Byte 3 / Bit7-Bit0	92
6.1.3 Serial Data String Request	92
6.1.3.1 Serial Requests with ASCII Characters (hopf Standard and hopf 2000).....	92
6.2 Data String Transmission Points of Time	93
6.3 Data Strings.....	94
6.3.1 General Information about Data Output of Board 6844(RC)	94
6.3.2 hopf Standard String (6021).....	95
6.3.2.1 Specified Settings	95
6.3.2.2 Structure	95
6.3.2.3 Status	95
6.3.2.4 Example.....	96
6.3.3 Data String for NTP (Network Time Protocol).....	97
6.3.3.1 Specified Settings	97
6.3.3.2 Structure	97
6.3.3.3 Status	97
6.3.3.4 Example.....	97
6.3.4 hopf 2000 - 4 Digit Year Output.....	98
6.3.4.1 Specified Settings	98
6.3.4.2 Structure	98
6.3.4.3 Status	99
6.3.4.4 Example.....	99
6.3.5 hopf Master/Slave-String.....	100
6.3.5.1 Specified Settings	100
6.3.5.2 Structure	101
6.3.5.3 Status	102
6.3.5.4 Example.....	102
6.3.6 SINEC H1	103
6.3.6.1 Specified Settings	103
6.3.6.2 Structure	103
6.3.6.3 Status	104
6.3.6.4 Example.....	104
6.3.7 T-String	105
6.3.7.1 Specified Settings	105
6.3.7.2 Structure	105
6.3.7.3 Status	105
6.3.7.4 Example.....	105
6.3.8 IBM Sysplex Timer Model 1+2	106
6.3.8.1 Specified Settings	106
6.3.8.2 Structure	106
6.3.8.3 Status	107
6.3.8.4 Example.....	107
6.3.9 Data String ALOHA	108
6.3.9.1 Specified Settings	108
6.3.9.2 Structure	108
6.3.9.3 Status	108
6.3.9.4 Example.....	108
6.3.10 SINEC H1 Extended	109
6.3.10.1 Specified Settings	109
6.3.10.2 Structure	109
6.3.10.3 Status	110
6.3.10.4 Example.....	110
6.3.11 NMEA 0183 - GPRMC (V3.00)	111
6.3.11.1 Specified Settings	112
6.3.11.2 Structure (GPS / Sub-Master).....	112
6.3.11.3 Status	115
6.3.11.4 Example.....	115
6.3.12 SAT 1703 Time String.....	116
6.3.12.1 Specified Settings	116
6.3.12.2 Structure	116
6.3.12.3 Status	117
6.3.12.4 Example.....	117

6.3.13 NMEA 0183 - GPZDA (V3.00) (GPS)	118
6.3.13.1 Specified Settings	119
6.3.13.2 Structure	119
6.3.13.3 Status	120
6.3.13.4 Example.....	120
6.3.14 GPS2000 Data String.....	121
6.3.14.1 Specified Settings	121
6.3.14.2 Structure	121
6.3.14.3 Status	122
6.3.14.4 Example.....	122
6.3.15 IEC-103 (ASDU Type 6)	123
6.3.15.1 Specified Settings	123
6.3.15.2 Structure	124
6.3.15.3 Example.....	124
6.3.15.4 Initialization String for IEC-103 (ASDU Type 6)	125
6.3.16 ABB-SPA Seconds-Clock	126
6.3.16.1 Specified Settings	126
6.3.16.2 Structure	127
6.3.16.2.1 Date and Time String	127
6.3.16.2.2 Second String	128
6.3.16.3 Status	128
6.3.16.4 Examples	128
6.3.16.4.1 Date and Time String	128
6.3.16.4.2 Second String	128
6.3.17 SPT String.....	129
6.3.17.1 Specified Settings	129
6.3.17.2 Structure	129
6.3.17.3 Status	130
6.3.17.4 Example.....	130
6.3.18 hopf Analysis String 01	131
6.3.18.1 Specified Settings	131
6.3.18.2 Example.....	131
7 6844RC - Functionality	132
7.1 RC-Pulses IMP 1-4 and RC-Output 1-4	133
7.1.1 RC-Pulses IMP 1-4 - Operating	135
7.1.2 RC-Pulses IMP 1-4 - Time Status.....	135
7.1.3 RC-Pulses IMP 1-4 - Cyclical Pulse.....	135
7.1.4 RC-Pulses IMP 1-4 - Daily Pulse	136
7.1.5 RC-Pulses IMP 1-4 - Single Pulse	136
7.1.6 RC-Pulse IMP 1-4 - One Time / Variable Pulse per Weekday	138
7.2 LAN Management Board 6844MNG for 3U / Table / Wall Systems	139
7.3 LAN Management Module 6844MNG for 1U System.....	139
8 Function Boards	140
8.1 Function Boards for System-Bus	141
8.2 Function Boards	141
8.3 Function Boards Summary	141
8.4 Exchanging a Function Board.....	142
8.5 Installation of an Additional Function Board	143
8.6 Removing Function Boards	143
9 System Indicators / Fault Analysis / Troubleshooting	144
9.1 Status and Fault Indicators	144
9.1.1 Status LEDs	144
9.1.1.1 "Power" LED (1U Systems only).....	144
9.1.1.2 "Sync. Status" LEDs (1U Systems only)	144
9.1.1.3 LED Power Supply Unit (not for 1U)	144
9.1.2 LCD-Display	144

9.1.2.1	System Status on the Display	144
9.1.2.2	Number of Satellites (GPS only)	144
9.1.2.3	Position Display (GPS only)	145
9.1.2.4	SyncOFF Timer	145
9.1.2.5	Display of ERROR-Byte	145
9.1.2.6	Settings of the SYSTEM-Byte	145
9.1.3	Error Relays (1U Systems only - Optional for 3U / Table-Top / Wall)	145
9.1.3.1	"Power" Relay	145
9.1.3.2	"Sync" Relay	145
9.1.4	Send LED	146
9.1.5	Auto-Reset Logic (System-Bus)	146
9.1.6	Serial Output of Data Telegrams	147
9.1.7	RC-Functionality (6844RC Systems only)	147
9.2	Error Patterns	147
9.2.1	Complete Failure	147
9.2.2	"Power" / Power Supply LED "ON" - No Display and No Output	148
9.2.3	Power LED "ON" - No Display but Valid Signal Output	148
9.2.4	Power LED "ON" - Cyclical Flickering of the Displays	148
9.2.5	No GPS Reception / No Synchronization	148
9.2.6	No DCF77 Antenna Simulation (77.5kHz) / DCF77 Pulse (1Hz)	150
9.2.7	No or Incorrect Serial Output	150
9.2.8	Incorrect Time Output	150
9.2.9	No Daylight Saving Time (DST) Changeover	151
9.2.10	Output and Function Errors of individual Function Boards	151
9.3	Support from the hopf Company	151
10	Maintenance / Care	152
10.1	General Guidelines for Cleaning	152
10.2	Cleaning the Housing	152
10.3	Cleaning the Display and Keypad	152
11	Technical Data	153
11.1	Specific Technical Data for 3U / Table-Top / Wall	153
11.2	Specific Technical Data for 1U	154
11.3	General Technical Data 6844(RC)	155
11.3.1	Internal System Accuracy	156
11.3.2	Signal Outputs	157
12	Appendix	159
12.1	Factory-Default Values	159
12.2	GPS (Global Positioning System)	160
12.3	DCF77 (German Long-Wave Transmitter Frankfurt 77.5kHz)	161
12.3.1	DCF77 General	161
12.3.1.1	DCF77 Signal Structure	161
12.3.1.2	Advantages and Disadvantages DCF77	163
12.3.2	DCF77 Generation by hopf Clocks	163
12.3.2.1	DCF77 Signal Simulation	163
12.3.2.2	DCF77 Pulse (1Hz)	163

1 Description of System 6844 and 6844RC

hopf Systems 6844 and 6844RC offer a broad range of functionality combined with ease of integration and are suitable for the needs of modern industry and the current computer and network environment in which these systems are used.

Tried and tested worldwide, **hopf** GPS System 6842 served as the basis for the further development of **hopf** Systems 6844 and 6844RC.

In designing the Systems, particular attention was paid to their potential for universal application combined with an optimal cost-benefit ratio for the different fields of use.

Furthermore, these Systems allow customized solutions to be created quickly and easily to meet specific project requirements.

Synchronisation (GPS and Sub-Master)

The **hopf** Systems 6844 and 6844RC are available as GPS systems and also as Sub-Master (Slave) Systems. A GPS System having GPS receiver can also be configured as a Sub-Master (Slave) System.

Functionality

The functionality of the Systems ranges from the simple emission of serial strings or pulses to the sophisticated NTP time server with LAN management and monitoring as well as a variety of other complex applications.

A range of function boards are available for the respective applications which can be used to meet almost all customer requirements - from a simple pulse output in the widest possible variety of hardware applications to the highly accurate NTP time server.

Modularity

In their standard configurations, the Systems already offer appropriate modularity in terms of the use of different function boards, housings, power supplies and subsequent expandability.

The Systems can also be supplied with additional expansion options. This makes it possible to easily adapt the Systems in accordance with changing future requirements.

Housing Options

hopf Systems 6844 and 6844RC are available to the customer in a variety of housing options to permit their use in almost any application.

Maintenance free

Complete maintenance free (no additional service costs) and high equipment reliability result in great flexibility and a high degree of availability.

Expansion

The System can be extended using Function Boards which can be added by the customer. In this way, functionality can be easily upgraded on site at low cost. Function Boards can also be exchanged directly on site. Direct account of the potential for subsequent local on-site expansion by the customer can be taken at the system design stage.

Customized System Structures

Based on the standard system, projects and special designs can be realized at low cost.

For this purpose, please consult the expert team at **hopf** Elektronik GmbH - now with the almost 40 years of experience in the field of time synchronization - we will be pleased to help.

Some of the System's base functions:

- Systems available as GPS and Sub-Master (Slave) Systems
- GPS Systems also usable as Sub-Master (Slave) Systems
- Synchronization is possible with only **one satellite** (GPS only)
- Synchronisation of Sub-Master (Slave) Systems via different standard signals
- Simple operation via **keypad** and **LCD-display** on the front panel
- All **cable connections** on the rear side (19 inch rack 1U/3U only)
- **DC Power Supply (Option)**
- Housing with additional **earth screw** for cables up to 16mm²
- Power input with **mains switch (1U only)** compliant with IEC/EN 60320-1/C14 and EMI **line filter**
- Prepared for **retrofitting** of Function Boards by the customer
- Up to two independent **NTP time servers** can be implemented on one System
- Two independent **serial interfaces** (each in RS232 and RS422 format)
- Output of a freely programmable **digital IRIG-B** pulse
- **High freewheel accuracy** due to control of the internal quartz base
- **Potential isolation** of the GPS antenna circuit (GPS only)
- Completely **maintenance-free** System
- **SyncOFF timer** (reception failure bypassing) for error message-free operation even in difficult synchronisation conditions.
- Redundant **multiple synchronization signal verification** for error-free and leap-free signal evaluation
- Maintenance-free buffered **back-up clock** for three days

Additional Functions of System 6844RC

- All settings on Control Board 6844RC can be carried out via a **serial remote interface** using the **hmc** Remote Software.
- Internal output of **4 highly accurate, freely configurable signals / pulses**.
- With an **optional LAN Management Board**, all settings on the Control Board can be performed and the System monitored via LAN.

Extension options

- Customer-specific system adaptations for "tailor-made" project solutions.

1.1 Difference between Systems 6844 and 6844RC

Both Systems are identical in their basic function and are based on the same hardware platform. However, System 6844RC also has more features and options.



In this description, the **notation 6844(RC)** means that the statements refer to both Systems.



Subsequent local on-site activation of RC functionality is **not** possible.

System 6844RC is designed for use in conjunction with management systems.

The System can be configured via serial interface and monitored in a network environment by using a LAN Management Board / Module 6844MNG (SNMP/SYSLOG/e-mail notification) and configured via the **hopf** Management Console (**hmc**).

In the 6844RC version, four additional high-precision, programmable internal pulses are available, which can be configured exclusively via the **hopf** Management Console (**hmc**).

The serial connection is made via interface COM0. Optionally, a separate remote interface can also be integrated into the System so that both interfaces COM0 and COM1 are exclusively available for customer applications.

1.2 Structure of Housing Options

The following section describes the differences between the housing options.

1.2.1 Differences between the Housing Options

The following table provides a summary of the different functions and extensions of the various housing options.

Description	3U		1U	TableTop	Wall
	42HP	84HP	84HP	42HP	42HP
2 independent serial interfaces each with RS232 and RS422 level	✓	✓	✓ ⁽¹⁾	✓	✓
Slots for Function Boards (for Boards with / without System-Bus)	2	2	2	2	1 ⁽⁴⁾
Optional slot extensions for Function Boards without System-Bus	2	11 ⁽²⁾	✗	✗	✗
Redundant power supply units (with / without additional power feed)	✗	optional	✗	✗	✗
System status via LEDs / relays	optional	optional	✓	optional	optional
LAN Management Board / Module suitable for integration (6844RC only)	✓	✓	✓	✓	✓
Optional slot prepared for LAN Management Board / separate remote interface (6844RC only)	✓ ⁽³⁾	✓ ⁽³⁾	✗	✓ ⁽³⁾	✓ ⁽³⁾
Standard voltage	115 / 230V AC	115 / 230V AC	100 - 240V AC	115 / 230V AC	115 / 230V AC
Temperature controlled forced ventilation	✗	✗	✓	✗	✗
Local on-site exchange of Control Boards possible with display and keypad	✓	✓	✗	✓	✓
Local on-site exchange of power supply unit possible	✓	✓	✗	✓	✓
Local on-site exchange / installation of Function Boards possible	✓	✓	✓	✓	✓
Optional DC power supplies (including voltage terminal converted to DC)	24V DC	✓	✓	✓	✓
	48V DC	✓	✓	✓	✓
	110V DC	✓	✓	✓	✓
	220V DC	✓	✓	✓	✓

- (1) Alternative pin terminal design and pin assignment
 (2) Standard power supply unit max. 20VA
 (3) One optional expansion slot or the serial interface is lost
 (4) Second slot available by removing the serial interface



It is **not** possible to freely combine all options and extensions.

For technical clarification of specific combinations of equipment features and functions, please consult the expert team at **hopf** Elektronik GmbH – we will be pleased to advise you.

1.2.2 System Design 6844(RC) in 19 inch Rack 3U/42HP and 3U/84HP

As standard, the System is assembled in a standard ½ 19" rack (3U/42HP). Optionally, the System is also available in a 1/1 19" rack (3U/84HP).

The base system consists of the following:

- 1/1 resp. ½ 19" module rack 3U
- Supply voltage 115/230V AC – other voltages available
- Voltage input with IEC/EN 60320-1/C14 connection and EMI line filter
- Connection for protection earth (PE) cables up to 16mm²
- System front panel with LCD-Display (2x16), keypad (25 keys)
- Control Board 6844(RC) for:
 - Synchronization signal reception and evaluation
 - Keypad control
 - Display control
 - System-Bus control
 - Time distribution in the system
- Two independent serial interfaces
- DCF77 antenna simulation (77.5kHz) via BNC connector
- System-Bus with two expansion slots

System front side 3U/42HP:

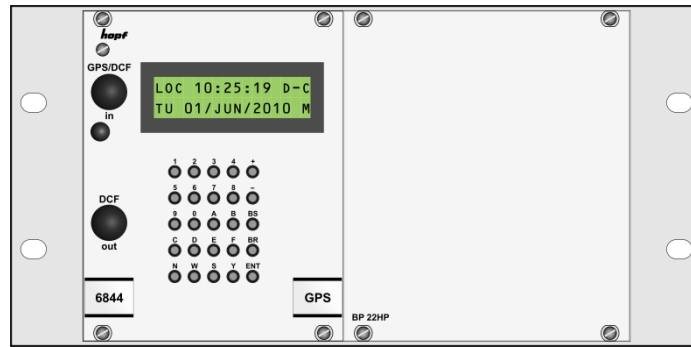

System rear side / plug-in side 3U/42HP:

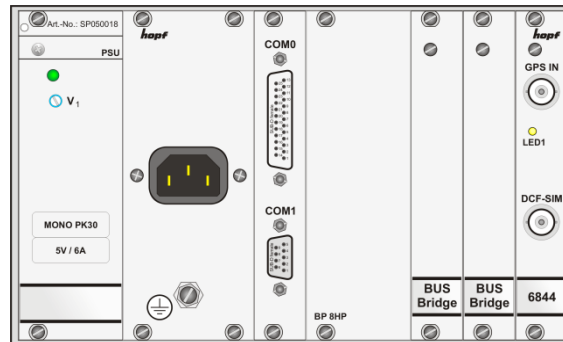

System front side 3U/84HP:



System rear side / plug-in side 3U/84HP:

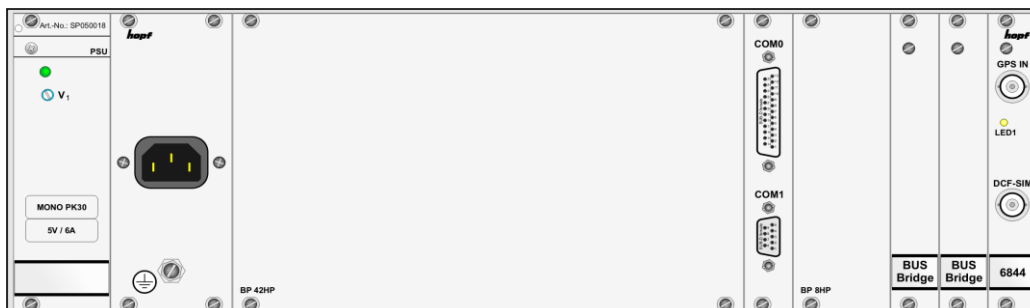

1.2.2.1 19 Inch Rack 3U/42HP and 3U/84HP

As standard, the System is assembled in a standard ½ 19" housing (3U/42HP) for control cabinet installation.

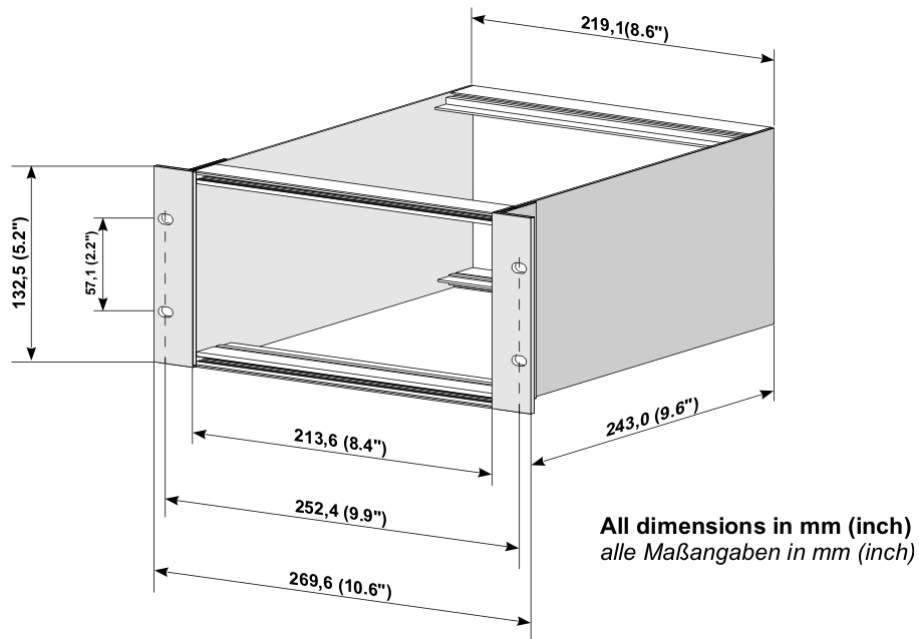

Optionally, the System is also available in a 1/1 19" rack (3U/84HP) for control cabinet installation.

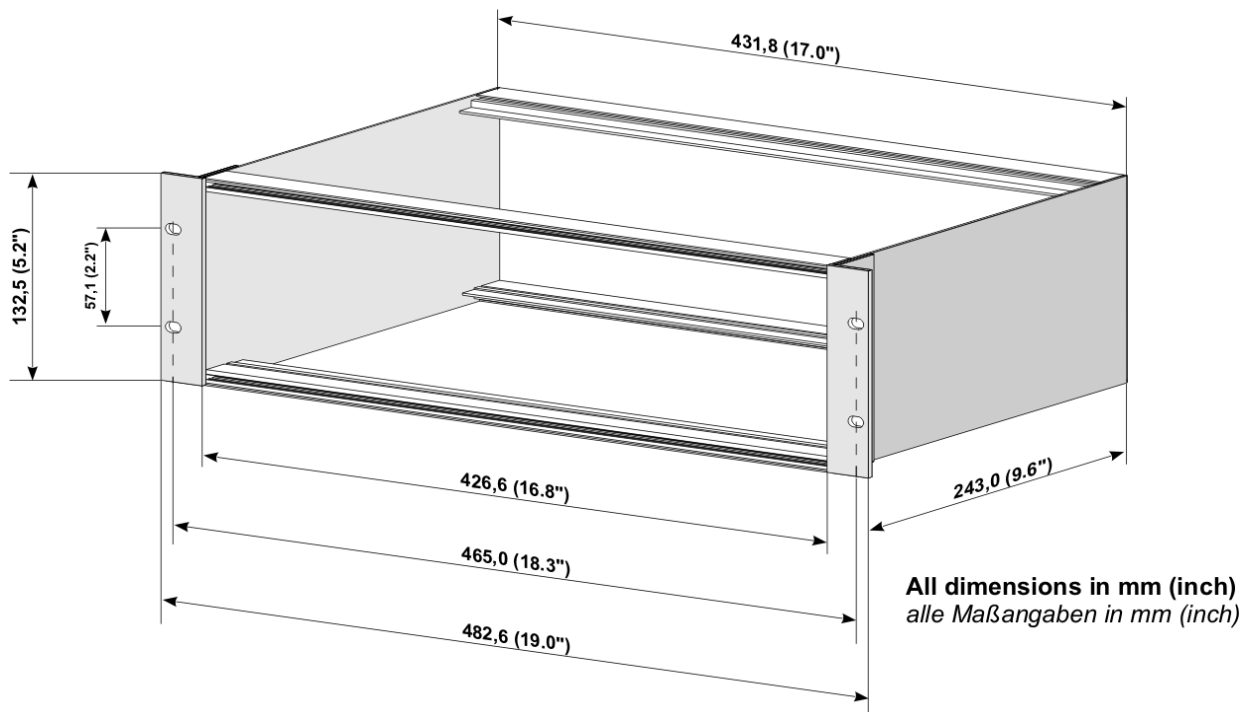

1.2.2.2 Display and Keypad

Display

The display consists of a two-line LCD-Display (Liquid Crystal Display) with 2x16 characters and back-lighting.



The lighting is activated by pressing a key and switches off automatically after approx. 4 minutes with no action required on the keypad.

For a description of the display functions please see **Chapter 5 System Parameterization and Operation**.

Keypad

The alphanumeric keypad with 25 keys provides menu-driven operation of the clock system.

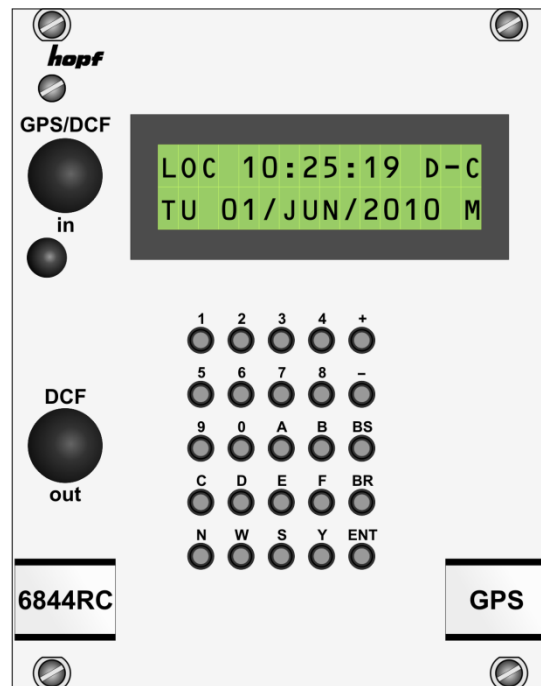

1.2.2.3 System-Bus 6000

System 6844(RC) contains the System-Bus which is made up of Bus Board with VG ledges, by means of which Control Board 6844(RC) and the Function Boards are connected.

The System-Bus is used to:

- Distribute time information.
- Communicate between Control Board 6844(RC) and Function Boards.
- Transmit the regulated second pulse (PPS). This serves to synchronize the data output of the installed Function Boards.
- Distribute the regulated DCF77 pulse (generated by Control Board 6844(RC)).
- Continuous auto-reset circuit for ongoing monitoring of the System-Bus Function Boards in the System.
- Power supply to the installed Boards.

Each active (sending and receiving) Function Board built into the System-Bus has a **SEND** LED. This LED indicates which Function Board is active on the System-Bus at the time.

Function Boards that only receive data from the System-Bus do not have a **SEND** LED.

1.2.2.4 Slots for Function Boards

In System 6844(RC), up to two Function Boards can be installed as standard. In principle, the slot for each 'Function Board' / 'System-Bus Function Board' is freely selectable.



Exceptions with regard to slot selection can be found in **Chapter 8 Function Boards**.

1.2.3 System Design 6844(RC) in 19 inch Rack 1U/84HP (Slim Line)

The system can be individually configured for various applications due to its partly modular design and can be easily upgraded or converted to suit changes in the application conditions.

The base system consists of the following:

- 1/1 19" module rack 1U/84HP (Slim Line)
- Wide-ranging power supply unit from 100-240V AC / 20VA (47-63Hz)
Other input voltages available
- Voltage feed with power switch with connections in accordance with IEC/EN60320/C14 including EMI line filter
- Connection for protection earth (PE) cables up to 16mm²
- System front panel with LCD-Display (2x16), keypad (20 keys) and status LEDs

System front panel:

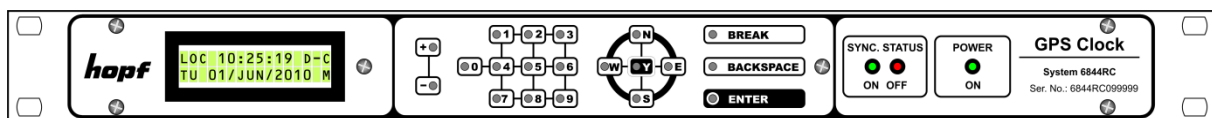

- Control Board 6844(RC) for:
 - Synchronization signal reception and evaluation
 - Keypad control
 - Display control
 - System-Bus control
 - Time distribution in the system
- Two independent serial interfaces
- DCF77 antenna simulation (77.5kHz) via BNC connector (not available with installed LAN management module)
- System-Bus with two expansion slots

System rear side / plug-in side:

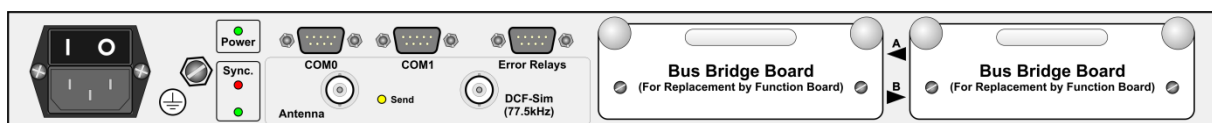

1.2.3.1 19 Inch Rack 1U/84HP

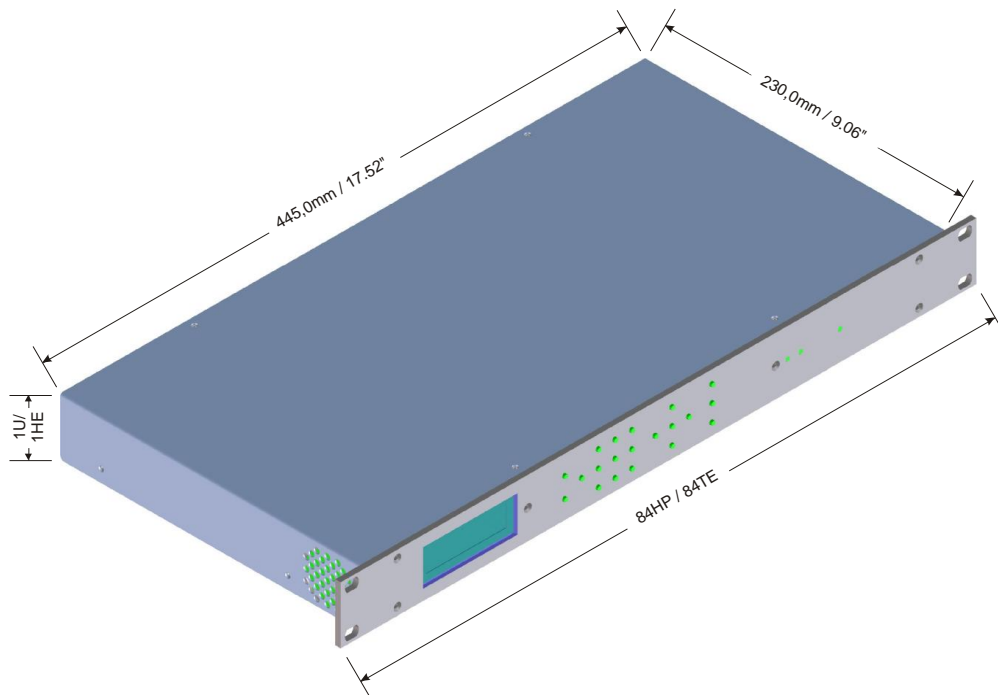

1.2.3.2 Display

The display consists of a two-line LCD-Display (Liquid Crystal Display) with 2x16 characters and back-lighting.



The lighting is activated by pressing a key and switches off automatically after approx. 4 minutes with no action required on the keypad.

For a description of the display functions please see **Chapter 5 System Parameterization and Operation**.

1.2.3.3 Keypad

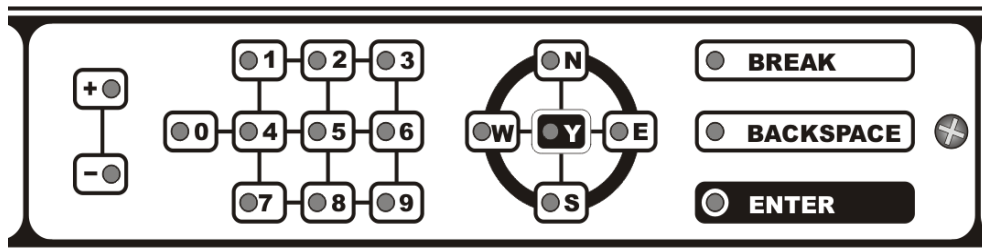

The alphanumeric keypad with 20 keys provides menu-driven operation of the clock system.



1.2.3.4 Status LEDs

The 1U System has status LEDs on both the front and rear sides. These allow the System status to be recognized in the installed condition in the control panel, whilst operating via the front panel as well as whilst checking the cabling on the rear side of the System.

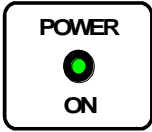
The LEDs indicate the following System conditions:

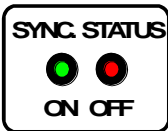
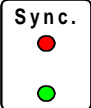
		Power (green)	ON OFF	The System is in operation The System is out of operation (for example, it is switched off, defective or the power supply has failed)
Front side	Rear side			
		Sync. (red) respectively Sync. (green)	ON ON	SYNC. STATUS OFF - The system is not currently synchronized by the adjusted Sync.-Source SYNC. STATUS ON - The system is currently synchronized by the adjusted Sync.-Source or the SyncOFF Timer is active

1.2.3.5 System-Bus 6000

The System-Bus, consisting of the Bus Board with VG ledges, via which the Control Board 6844(RC) and the Function Boards are connected, can be found in the System 6844(RC).

The System-Bus serves to provide:

- Distribution of the time information.
- Communication between Control Board 6844(RC) and the Function Boards.
- Transmission of the regulated second pulse (PPS). This serves to synchronize the data output of the implemented Function Boards.
- Distribution of the regulated DCF77 pulse (generated by the Control Board 6844(RC)).
- Circular auto-reset circuit for ongoing verification of the System-Bus Function Boards to be found in the System.
- Power supply for the installed boards.

Each active Function Board (transmit and receive) which is linked to the System-Bus has a **SEND** LED. This LED signals which of the Function Boards is active on the System-Bus.

Function Boards which only receive data from the System-Bus do not have a **SEND** LED.

1.2.3.6 Function Board Slots

Up to two Function Boards can be implemented in the System 6844(RC) 1U Slim Line.

As a basic principle, the slot can be freely selected for each 'Function Board' / 'System-Bus Function Board'.



Exceptions of the slot selection can be found in **Chapter 8 Function Boards**

Only boards that have been adapted for the 1U Slim Line System can be used in these slots.

Slots that have been prepared for special functions are identified with the letters "A" and "B".

1.2.3.7 Temperature-controlled Forced Ventilation

The clock system has two temperature-controlled fans to prevent the operating temperature rising above the allowed limit as a result of thermal coupling with equipment mounted in the control panel.

These fans are mounted on the side ventilation apertures and switch in when the temperature in the equipment reaches approx. 45°C.



The ventilation apertures on the left and right hand sides must not be covered. Otherwise, active ventilation is ineffective and inadequate convection and/or thermal coupling with surrounding equipment may cause the temperature to rise above the equipment's maximum permissible operating temperature.

1.2.4 System Design 6844(RC) in ½ 19 inch Table Top Housing 3U/42HP

In essence, the System consists of the same components as the 3U System, except that the arrangement is in accordance with the differing requirements of the housing option.

System front side / plug-in side:

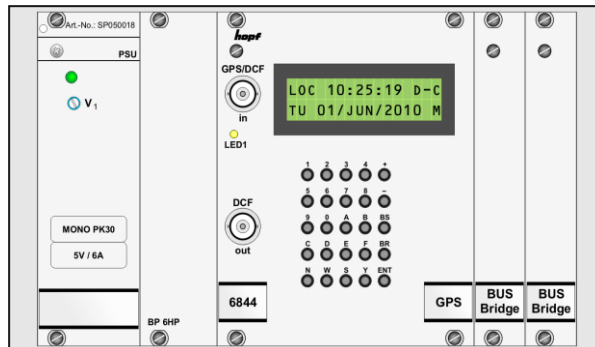

System rear side:

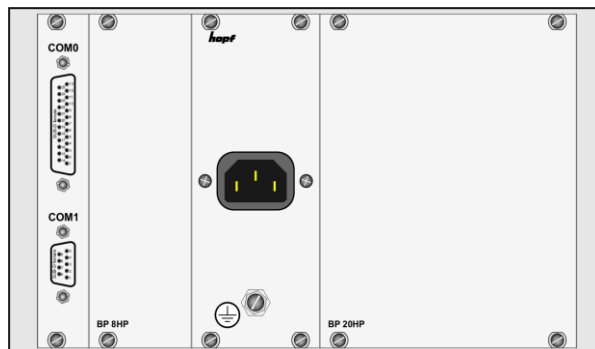

1.2.4.1 1/2 19 Inch Table Top Housing 3U/42HP

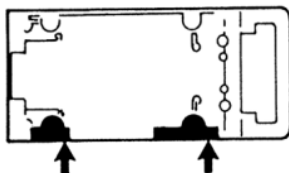
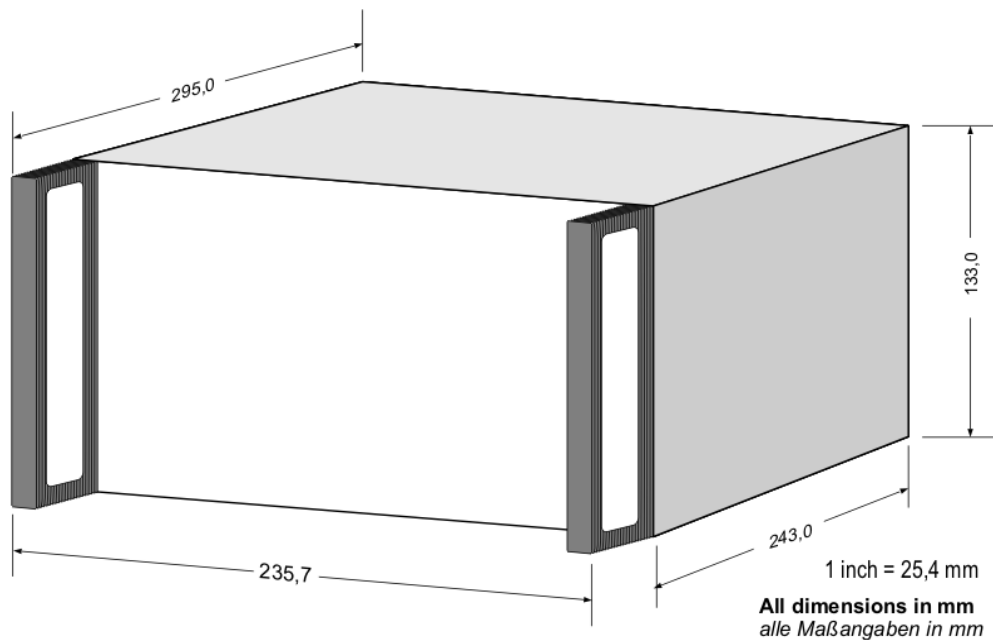

Retracted feet for rack installation retracted on the front- and backside
(Aufstellfüße für den Schrankeinbau front- und rückseitig eingeklappt)

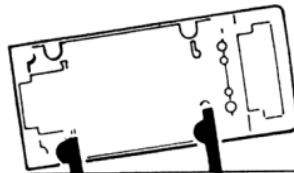

Feet in front with long and at the back with short side opened out
(Füße vorne mit langer und hinten mit kurzer Schenkelseite ausgeklappt)

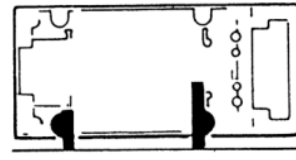

Feet in front and at the back on an even level opened out
(Füße vorne und hinten auf gleichem Höhenniveau ausgeklappt)

1.2.5 System Design 6844(RC) in 1/2 19 inch Wall Housing 3U/42HP

In essence, the System consists of the same components as the 3U System, except that the arrangement is in accordance with the differing requirements of the housing option.

System front side:

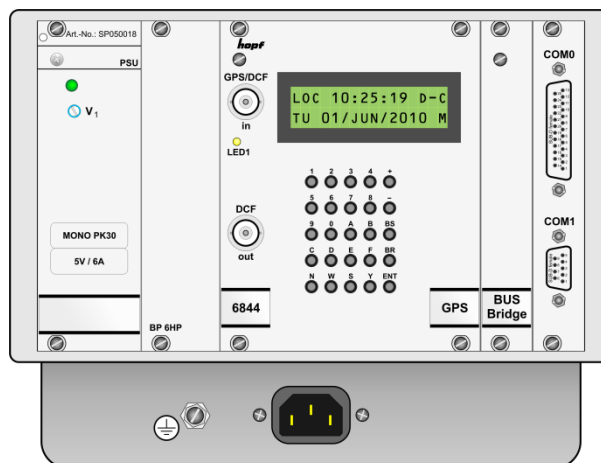

1.2.5.1 1/2 19 Inch Wall Housing 3U/42HP

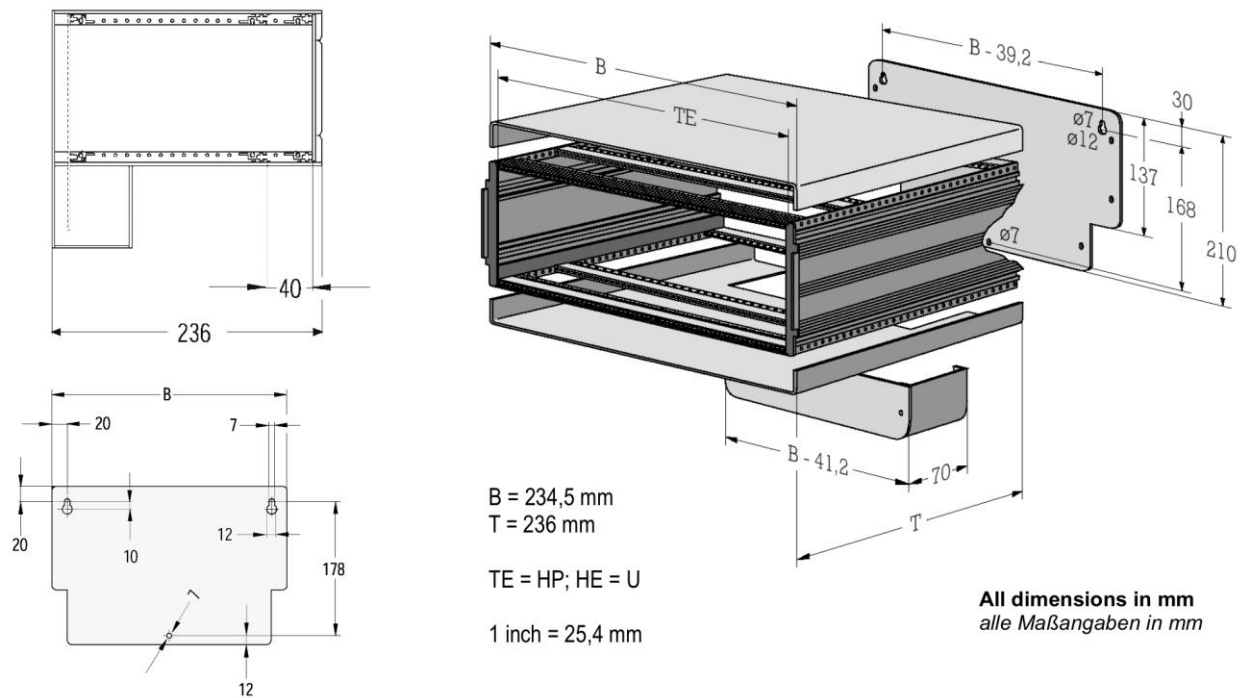

1.2.5.2 Slot for a Function Board

In System 6844(RC), due to the mechanics of the housing, only one Function Board can be installed in the wall-mounting housing as standard.

1.3 Quick Install

- Earthing System / connect power supply
- Connection of the GPS Antenna System (GPS only) and the appropriate synchronisation source for Sub-Master (Slave) Systems
- Switch on power supply
- Input local time and date
- Input difference time
- Input position (GPS only)
- Input changeover point of time **S** \Rightarrow **D**
- Input changeover point of time **D** \Rightarrow **S**
- Wait for minute change
- Trigger software reset
- Check for correct acquisition of the difference time using the **SHOW** function (GPS only)
- Check for correct acquisition of the position using the **SHOW** function
- Check for correct acquisition of the changeover point of time **S** \Rightarrow **D** using the **SHOW** function
- Check for correct acquisition of the changeover point of time **D** \Rightarrow **S** using the **SHOW** function
- Trigger hardware reset

The GPS version should be synchronous after less than 30 minutes, the Sub-Master (Slave) version after less than 5 minutes.

This can be checked by means of the:

- LCD-Display
- System Status LEDs (1U version only)

2 System 6844(RC) Synchronization

This Chapter describes the various options for synchronizing System 6844(RC).

GPS System 6844(RS) is also referred to as "Master-System". This System variant provides an internal GPS receiver.

Sub-Master (Slave) Systems are Systems 6844 (RC) that are synchronized by other Systems such as a Master System 6844 (RC). Depending on the synchronisation mode an additional hardware is required to connect the synchronisation signal to System 6844 (RC).

2.1 Summary / Synchronization Source Settings

System synchronization options and their required settings:

Menu \ Sync.Channel		Master	Sub-Master (Slave)					
		GPS Antenna Signal	Serial Data String		Special-Sync. Serial Data String		DCF77 pulse	
			without PPS	with PPS	"Local"	"UTC"	CET	World-wide
1.01	TIME	O	O		O		O	O
1.02	TIME OFFSET	+	-		+		-	+
1.03	CHANGEOVER TIME S⇒D (Standard time ⇒ Daylight saving time)	+	-		+		-	-
1.04	CHANGEOVER TIME D⇒S (Daylight saving time ⇒ Standard time)	+	-		+		-	-
1.31	SYSTEM-Byte / Synchronization Mode (Bit2 - Bit0)	000	001	010	110	111	011	100

- + Always required
- (+) Only when necessary
- o Not required - but possible
- Input not possible or no function

2.1.1 Synchronisation via GPS

GPS Clock Systems are synchronized by the time signal transmitted via the GPS satellites. Therefore the Master System 6844 (RC) provides an internal GPS receiver. For the reception of the GPS signal the installation of an appropriate GPS Antenna System is necessary. Details about GPS functionality is described in **Chapter 12.2 GPS (Global Positioning System)**.

The time basis received from GPS is based on UTC and does not contain any local time information such as difference time and changeover times. These parameters need to be configured for evaluation of the local time in the System.

2.1.2 Synchronization via Serial Interface

On this setting, the **hopf** Master/Slave string is transmitted to the clock via the COM1 serial interface. This setting blocks the interface for other types of data communication (e.g. cyclical time telegram output).

Functional Description for Synchronization via Serial Data String

A number of **hopf** radio-controlled clocks or systems can output the serial **hopf** Master/Slave string. This string serves for the synchronization of Sub-Master (Slave) systems. It contains all the necessary data from the transmitting clock system, such as hour, minute, second, day, month, year and status information. For the accuracy of the System the control character EXT (end of text) is transmitted on the second change.

The **hopf** Master/Slave data string can be transmitted every minute but also every second in order to obtain a better accuracy of the System. The interface parameters for this synchronization mode are firmly adjusted to 9600baud, 8 data bit, no parity and 1 stop bit.

Control Board 6844(RC) evaluates the data received and, following checks for plausibility and data verification, prepares the data for synchronization.

The highly precise setting of the internal time takes place with the start edge of the ETX, transmitted exactly on the minute changeover, and the internal quartz base is also readjusted after several data strings have been received.



Synchronization with the **hopf** Master/Slave string is only possible on COM1. When synchronization via **hopf** Master/Slave string is set then the serial parameters for COM1 are set automatically. All other settings of interface COM1 are ignored.



Received data on the serial interface that are not specified in the pertinent data string might disturb and interrupt the cyclic string output. The receiving synchronization interface should be set to "transmitting on request" for Sub-Master (Slave) Systems.

2.1.3 Synchronisation via Serial Interface with High-Accurate PPS

In this synchronisation mode System 6844 (RC) gets, in addition to the serial data string for the time synchronisation, a PPS (Pulse per second) generated by the Master System. The time information is adopted from the serial data string in the synchronisation mode "Synchronisation via serial interface". The additional PPS determines in this mode the internal accuracy of the Sub-Master System.

This mode allows the synchronisation of the Sub-Master System with likely the same accuracy as the Master System.



PPS input feed is **not** available on the standard version of this equipment type. If such an input is required then this must be installed by **hopf** prior to delivery. Retrofitting by the customer is **not** possible.



Received data on the serial interface that are not specified in the pertinent data string might disturb and interrupt the cyclic string output. The receiving synchronization interface should be set to "transmitting on request" for Sub-Master (Slave) Systems.

2.1.4 Special Sync. via serial interface with LOCAL time (FE1000)

This synchronization mode is particularly used for the synchronization of systems with IRIG-B input and evaluation board FE1000.

This setting is used when the IRIG-B signal fed into board FE1000, uses the time base LOCAL.

Hereby the internal synchronization of the system is processed via a serial **hopf** Master/Slave-String:

- Time basis of the synchronization signal: **Local Time**
- The difference time can be freely adjusted in the system (independent from IRIG-B signal)
- The summer-/winter time switch-over is processed by the switching points set in the system so far they have been entered (independent from IRIG-B signal)



Received data on the serial interface that are not specified in the pertinent data string might disturb and interrupt the cyclic string output. The receiving synchronization interface should be set to "transmitting on request" for Sub-Master (Slave) Systems.

2.1.5 Special Sync. via serial interface with UTC time (FE1000)

This synchronization mode is particularly used for the synchronization of systems with IRIG-B input and evaluation board FE1000.

This setting is used when the IRIG-B signal fed into board FE1000, uses the time base UTC.

Hereby the internal synchronization of the system is processed via a serial **hopf** Master/Slave-String:

- Time basis of the synchronization signal: **UTC**
- The difference time can be freely adjusted in the system (independent from IRIG-B signal)
- The summer-/winter time switch-over is processed by the switching points set in the system so far they have been entered (independent from IRIG-B signal)



Received data on the serial interface that are not specified in the pertinent data string might disturb and interrupt the cyclic string output. The receiving synchronization interface should be set to "transmitting on request" for Sub-Master (Slave) Systems.

2.1.6 Synchronization via DCF77 Pulse - CET / WORLDWIDE

DCF77 time information is transmitted in digital form with the DCF77 pulse. As in the case of DCF77 antenna simulation (77.5kHz), this signal can be generated by **hopf** GPS equipment and therefore can also be used for synchronization worldwide. In the case of the DCF77 pulse (1Hz), the parameters which require to be set by the customer are defined by the selected installation location.

For further information about the signals see **Chapter 12.3.2.2 DCF77 Pulse (1Hz)**.



DCF77 pulse input feed is **not** available on the standard version of this equipment type. If such an input is required then this must be installed by **hopf** prior to delivery. Retrofitting by the customer is **not** possible.

The use of the DCF77 signal means that the system, in principle, is synchronized with local time (standard time with ST/WT changeover, if required). Certain points must be noted in order for the system to transmit both local time and UTC time correctly.



In this synchronization mode the UTC time is a calculated time which is determined on the basis of the time offset and changeover points of time for summer time and winter time.

The DCF77 Transmitter (location: Mainflingen, Frankfurt am Main / Germany) always transmits time information as local time (CET/CEST). This means that **UTC time is calculated** for DCF77 systems. Two variables are now required in order to convert from local time to UTC time:

- **The time offset between UTC and the valid standard time (winter time) in the respective time zone**
- **The changeover points of time between winter time and summer time – provided that such changeover takes place in the respective time zone**

The signal received via the DCF77 antenna contains this required information for the CET time zones (UTC+1h).

As a result, when configuring, it is necessary to differentiate between system operation in the CET time zone and system operation as a slave or Sub-Master system for worldwide application.

2.1.6.1 Operation in the CET Time Zone (Europe)

If the system is configured for operation in the CET time zone, settings for time offset and changeover points of time are not required or are ignored, since the time offset is fixed and the DST changeover is controlled by information contained in the synchronization signal.



Fixed time offset: Standard time (winter time) ⇒ UTC + 1h
Daylight saving time ⇒ UTC + 2h

Changeover point of time + current time status (summer or winter time) are taken from the synchronization signal

2.1.6.2 Operation in a different Time Zone (Worldwide)

If the system is configured for worldwide application, in order for UTC time output to be correct, the time offset must be parameterized for the respective time zone. Settings for the changeover points of time are not required, or are ignored, since the DST changeover is controlled by the information contained in the synchronization signal.



Time offset: Standard time (winter time) ⇒ Set time offset
Daylight saving time ⇒ Set time offset +1h

Changeover point of time + current time status (daylight saving time or standard time) are taken from the synchronization signal

3 Installation

The following describes the installation of the System hardware.

3.1 System 6844(RC) in 3U / Table-Top / Wall - Housing

3.1.1 Installation of the 19 Inch 3U Rack

The System is assembled in a standard 3U/42HP or 3U/84HP 19" housing for control cabinet installation (for dimensions see **Chapter 1.2.2 System Design 6844(RC) in 19 inch Rack 3U/42HP and 3U/84HP**)

The following steps are to be carried out:

- Place the rack in the control panel and fix to the mounting brackets on the front side of the rack using 4 screws.



The ventilation apertures on the top and bottom sides must not be covered. Otherwise passive ventilation (convection) will not be effective and lack of convection and / or thermal coupling with surrounding equipment may give rise to an excessive equipment operating temperature.



At higher temperatures an active cooling / ventilation is recommended.

- Ensure that there is sufficient space between the connection side of the rack and the control panel to allow for the connection of cables to the System.

3.1.2 Installing the Table-Top Housing

Fixing toes for rack installation retracted on the front- and backside
(Aufstellfüße für den Schrankeinbau front- und rückseitig eingeklappt)

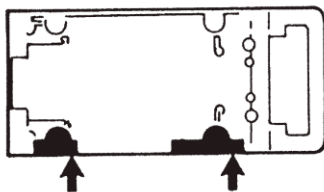

Toes in front with long and at the back with short side opened out
(Füße vorne mit langer und hinten mit kurzer Schenkelseite ausgeklappt)

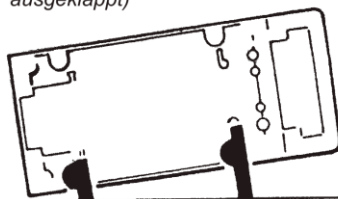

Toes in front and at the back on an even level opened out
(Füße vorne und hinten auf gleichem Höhenniveau ausgeklappt)

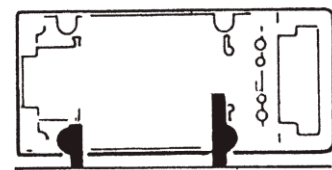

3.1.3 Mounting the Wall Housing

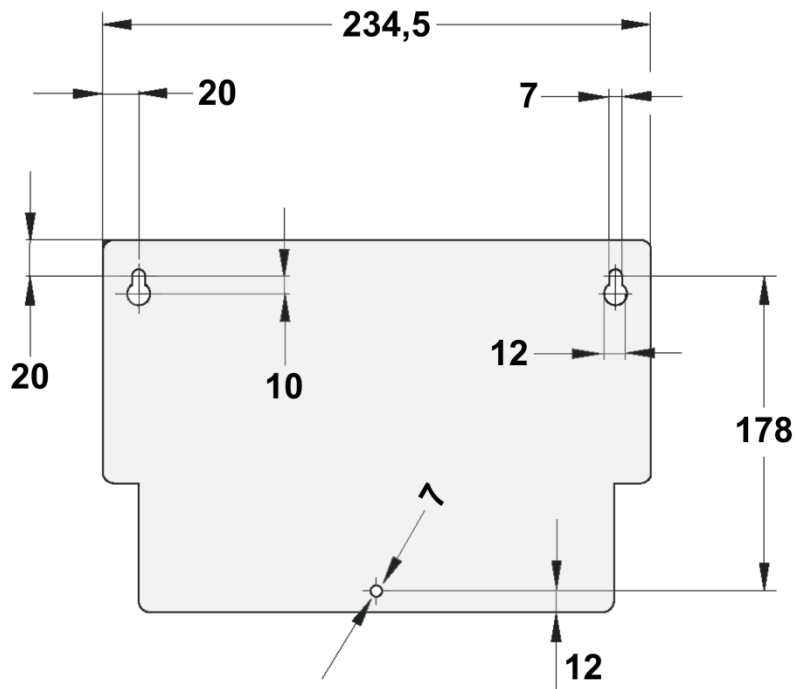

3.1.4 Earthing

The System 6844(RC) is usually earthed via the PE cable of the power supply.

An additional earth cable (up to 16mm²) for surge protection purposes can be connected by means of the earth screw located on the System housing.

3.1.5 AC Power Supply

Attention should be paid to the following when connecting the power supply:

- Correct voltage type (AC or DC)
- Voltage level

The power feed is via an input connector with EMI line filter compliant with IEC/EN 60320-1/C14

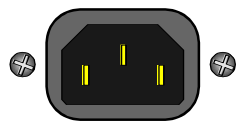

- Plug the input connector into the System's mains power inlet.
- Connect the input connector to the mains power supply and switch the line circuit breaker on.



The System 6844(RC) can be damaged if incorrect voltage is connected.

3.1.6 Safety and Warning Instructions

Please read these instructions fully in order to guarantee safe operation of the equipment and to be able to use all the functions.



Caution: Never work on an open unit when voltage is applied!
Danger to life!

The System 6844(RC) is an installation device. Installation and commissioning may only be carried out by suitably qualified specialist personnel. In doing so the respective country-specific specifications must be observed (e.g. VDE, DIN).

Before commissioning ensure that:

- The power supply has been connected correctly and electrical shock protection is in place
- The earth wire is connected
- All supply cables are correctly sized and fused
- All output cables are suitably sized or specially fused for the max. output current of the equipment
- Sufficient convection is guaranteed

The equipment contains life-threatening components and a high level of stored energy.

3.1.6.1 Power Supply Unit Specifications

All AC power supply specifications are described in **Chapter 11 Technical Data**.

3.1.6.2 Fusing

Pay attention to the correct fusing of the power supply when connecting the System 6844(RC).

The corresponding performance data can be taken from the equipment nameplate. The System 6844(RC) is currently fitted with a power supply unit with a power consumption of max. 20 VA.



If the internal fuse (device protection) trips it is highly probable that the equipment is faulty. In this case the device should be checked in the factory.

3.1.7 DC Power Supply (Option)



Ensure that the external power supply is switched off. When connecting the supply cable make sure that the polarity is correct and the equipment is earthed.

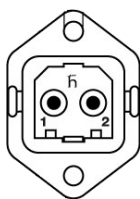

- The cable of the power supply is connected using a 2-pole plug connector with additional earth connection and interlocked with the System 6844(RC):

+V_{in}: Positive pole (contact 1)

-V_{in}: Negative pole (contact 2)

PE: Earth



The System 6844(RC) can be damaged if incorrect voltage is connected.

3.1.7.1 Power Supply Unit Specifications

All DC power supply specifications are described in **Chapter 11 Technical Data**.

3.1.7.2 Fusing

Pay attention to the correct fusing of the power supply when connecting the System 6844(RC).

The corresponding performance data can be taken from the equipment nameplate. The System 6844(RC) is currently fitted with a power supply unit with a power consumption of max. 20 VA.



If the internal fuse (device protection) trips it is highly probable that the equipment is faulty. In this case the device should be checked in the factory.

3.1.8 Synchronization Source Connection

Depending on the version different synchronisation signals can be connected to the System 6844 (RC)

3.1.8.1 GPS Antenna Equipment

The GPS antenna equipment coaxial cable is connected to the BNC connector marked "**Antenna**" on the control board 6844(RC) of the System. More detailed specifications for the installation of the antenna equipment, such as cable lengths and types, can be found in the manual "Antenna Equipment GPS".

3.1.8.2 Serial String

The synchronisation string is always connected to interface COM1. The correct signal level has to be considered.



Received data on the serial interface that are not specified in the pertinent data string might disturb and interrupt the cyclic string output. The receiving synchronization interface should be set to "transmitting on request" for Sub-Master (Slave) Systems.

3.1.8.3 PPS (Pulse per second)



For PPS input an additional hardware depending on the signal level for synchronisation is required.

Insofar this option is factory set the connection and the signal level are stated in the supplied manual.

3.1.8.4 DCF77 Pulse



For DCF77 pulse input an additional hardware depending on the signal level for synchronisation is required.

Insofar this option is factory set the connection and the signal level are stated in the supplied manual.

3.1.9 COM0 / COM1 Serial Interfaces Connection

The serial interfaces are assigned as follows:

SUB-D female Connector 25-pole

COM0

Pin	Assignment
1	n.c.
2	TxD RS232c
3	RxD RS232c
4	n.c.
5	n.c.
6	n.c.
7	0V GND
8	n.c.
9	n.c.
10	n.c.
11	-TxD RS422 (low active)
12	+TxD RS422 (high active)
13	n.c.
14	n.c.
15	n.c.
16	n.c.
17	n.c.
18	n.c.
19	n.c.
20	n.c.
21	n.c.
22	-RxD RS422 (low active)
23	+RxD RS422 (high active)
24	n.c.
25	n.c.

SUB-D female Connector 9-pole

COM1

Pin	Assignment
1	GND
2	TxD RS232c
3	RxD RS232c
4	+RxD RS422 (high active)
5	-RxD RS422 (low active)
6	n.c.
7	n.c.
8	-TxD RS422 (low active)
9	+TxD RS422 (high active)

n.c.: not connected

3.1.10 DCF77 Antenna Simulation (77.5kHz) Connection

The antenna cable of the DCF77 System to be synchronized is connected to the System's BNC socket marked "DCF-Sim". A type RG59 coaxial cable is recommended as standard for the connection between **hopf** Systems.

3.1.11 Function Boards Connection / Input- and Output Modules

The necessary steps to connect the Function Boards should be consulted in the respective technical specifications of the Function Boards present in the system.

System 6844(RC) - V06.01

35 / 163

hopf Elektronik GmbH
 Nottebohmstr. 41 • D-58511 Lüdenscheid • Tel.: +49 (0)2351 9386-86 • Fax: +49 (0)2351 9386-93 • Internet: <http://www.hopf.com> • E-Mail: info@hopf.com

3.2 System 6844(RC) in 1U Slim Line Housing

3.2.1 Installation of the 19 Inch Rack

The System is assembled in a 1U/84HP 19" housing for control cabinet installation (measurement see **Chapter 1.2.3.1 19 Inch Rack 1U/84HP**).

The following steps are to be carried out:

- Place the rack in the control panel and fix to the mounting brackets on the front side of the rack using 4 screws.



The side ventilation apertures on the right and left hand sides must not be covered. Otherwise active ventilation will not be effective and lack of convection and / or thermal coupling with surrounding equipment may give rise to an excessive equipment operating temperature.

- Ensure that there is sufficient space between the connection side of the rack and the control panel to allow for the connection of cables to the System.

3.2.2 Earthing

The System 6844(RC) 1U Slim Line is usually earthed via the PE cable of the power supply.

An additional earth cable for surge protection purposes can be connected by means of the earth screw located on the rear side of the System housing.

3.2.3 AC Power Supply

The Systems' standard AC power supply unit is described here. However, the connection data on the nameplate of the respective unit is always applicable.

Attention should be paid to the following when connecting the power supply:

- Correct voltage type (AC or DC)
- Voltage level

The power feed is via an input connector with EMI filter compliant with IEC/EN 60320-1/C14

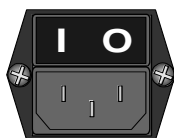

- Check that the mains power switch is in position " 0 " (= off).
- Plug the input connector into the System's mains power inlet.
- Connect the input connector to the mains power supply and switch the line circuit breaker on.



The System 6844(RC) can be damaged if incorrect voltage is connected.

3.2.3.1 Safety and Warning Instructions

Please read these instructions fully in order to guarantee safe operation of the equipment and to be able to use all the functions.



Caution: Never work on an open unit when voltage is applied!
Danger to life!

The System 6844(RC) is an installation device. Installation and commissioning may only be carried out by suitably qualified specialist personnel. In doing so the respective country-specific specifications must be observed (e.g. VDE, DIN).

Before commissioning ensure that:

- The power supply has been connected correctly and electrical shock protection is in place
- The earth wire is connected
- All supply cables are correctly sized and fused
- All output cables are suitably sized or specially fused for the max. output current of the equipment
- Sufficient convection is guaranteed

The equipment contains life-threatening components and a high level of stored energy.

3.2.3.2 Power Supply Unit Specifications

All AC power supply specifications are described in **Chapter 11.2 Specific Technical Data for 1U**.

3.2.3.3 Fusing

Pay attention to the correct fusing of the power supply when connecting the System 6844(RC) 1U Slim Line

The corresponding performance data can be taken from the equipment nameplate. Depending on the system configuration System 6844(RC) 1U Slim Line is equipped with a power supply unit providing a power consumption of max. 20 VA or rather 40 VA.



If the internal fuse (device protection) trips it is highly probable that the equipment is faulty. In this case the device should be checked in the factory.

3.2.4 DC Power Supply (Option)



Ensure that the external power supply is switched off. When connecting the supply cable make sure that the polarity is correct and the equipment is earthed.

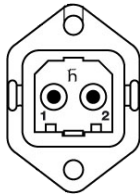

- The cable of the power supply is connected using a 2-pole plug connector with additional earth connection and interlocked with the System 6844(RC) 1U Slim Line:

+V_{in}: Positive pole (contact 1)
 -V_{in}: Negative pole (contact 2)
 PE: Earth



The System 6844(RC) 1U Slim Line can be damaged if incorrect voltage is connected.



Earthing:

By default the minus pole (-V_{in}) and earthing (PE) are connected system-sided.

3.2.4.1 Power Supply Unit Specifications

All DC power supply specifications are described in **Chapter 11.2 Specific Technical Data for 1U**.

3.2.4.2 Fusing

Pay attention to the correct fusing of the power supply when connecting the System 6844(RC) 1U Slim Line.

The corresponding performance data can be taken from the equipment nameplate. Depending on the system configuration System 6844(RC) 1U Slim Line is equipped with a power supply unit providing a power consumption of max. 20 VA or rather 40 VA.



If the internal fuse (device protection) trips it is highly probable that the equipment is faulty. In this case the device should be checked in the factory.

3.2.4.3 Reverse Voltage Protection

The version of System 6844(RC) 1U Slim Line with DC supply has reverse voltage protection. This protection prevents damage to the equipment due to an incorrectly connected DC power supply.

Protection is effected by means of a self-resetting fuse. In the case of reverse polarity, it is necessary to switch the equipment off for approx. 20 seconds after this fuse has tripped. The power supply can then be connected with the correct polarity.

3.2.5 Synchronization Source Connection

Depending on the version different synchronisation signals can be connected to the System 6844 (RC)

3.2.5.1 GPS Antenna Equipment

The GPS antenna equipment coaxial cable is connected to the BNC connector marked "**An-tenna**" on the control board 6844(RC) of the System. More detailed specifications for the installation of the antenna equipment, such as cable lengths and types, can be found in the manual "Antenna Equipment GPS".

3.2.5.2 Serial String

The synchronisation string is always connected to interface COM1. The correct signal level has to be considered.



Received data on the serial interface that are not specified in the pertinent data string might disturb and interrupt the cyclic string output. The receiving synchronization interface should be set to "transmitting on request" for Sub-Master (Slave) Systems.

3.2.5.3 PPS (Pulse per second)



For PPS input an additional hardware depending on the signal level for synchronisation is required.

Insofar this option is factory set the connection and the signal level are stated in the supplied manual.

3.2.5.4 DCF77 Pulse



For DCF77 pulse input an additional hardware depending on the signal level for synchronisation is required.

Insofar this option is factory set the connection and the signal level are stated in the supplied manual.

3.2.6 COM0 / COM1 Serial Interfaces Connection

The serial interfaces are assigned as follows:

<p>SUB-D male connector 9-pole</p> <p>COM0</p>	Pin	Assignment
	1	n.c.
	2	RxD RS232
	3	TxD RS232
	4	n.c.
	5	GND
	6	+TxD RS422 (high active)
	7	-TxD RS422 (low active)
	8	+RxD RS422 (high active)
	9	-RxD RS422 (low active)

<p>SUB-D male connector 9-pole</p> <p>COM1</p>	Pin	Assignment
	1	n.c.
	2	RxD RS232
	3	TxD RS232
	4	n.c.
	5	GND
	6	+TxD RS422 (high active)
	7	-TxD RS422 (low active)
	8	+RxD RS422 (high active)
	9	-RxD RS422 (low active)

n.c.: not connected

3.2.7 Error Relays Connection

<p>SUB-D male connector 9-pole</p> <p>ERROR Relays</p>	Pin	Assignment
	1	n.c.
	2	PWR - REL2 Common contact (c)
	3	PWR - REL2 Normally open contact (no)
	4	n.c.
	5	GND
	6	PWR - REL2 Normally closed contact(nc)
	7	SYNC - REL1 Normally closed contact (nc)
	8	SYNC - REL1 Common contact (c)
	9	SYNC - REL1 Normally open contact (no)

PWR = Power / Operation – SYNC = Synchron

3.2.8 DCF77 Antenna Simulation (77.5kHz) Connection

The antenna cable of the DCF77 System to be synchronized is connected to the System's BNC socket marked "DCF-Sim". A type RG59 coaxial cable is recommended as standard for the connection between **hopf** Systems.



DCF77 antenna simulation (77.5kHz) is not available in system 6844RC with installed LAN management module

3.2.9 Function Boards Connection / Input- and Output Modules

The necessary steps to connect the Function Boards should be consulted in the respective technical specifications of the Function Boards present in the system.

4 Commissioning



This chapter describes the commissioning of the system 6844(RC).

4.1 General Procedure

The commissioning procedure is as follows:

- Check the cabling:
 - Earth
 - Power supply
 - Connection of the GPS Antenna System (GPS only) and the appropriate synchronisation source for Sub-Master (Slave) Systems
 - GPS antenna equipment
 - COM0 / COM1 serial interfaces
 - DCF77 antenna simulation (77.5kHz)
 - Error relays (1U only)
 - Function Boards
- Isolate all plug connections to the output interfaces and Function Boards (recommended)
- GPS antenna equipment connection to the Sync.-Source remain in place (e.g. GPS antenna equipment, and so on)
- Switch on System 6844(RC)
- Power LEDs light up on front and rear sides (1U only)
- The start frame appears on the display (for approx. 3 seconds)
- Execute all parameter settings via the **SET menu** and also via the **INI** and **S.CLOCK menus** when necessary
- Check for successful synchronization of the System 6844(RC)
- Commission the Function Boards (where present):
 - Set the Function Board(s) parameters
 - Re-establish the plug connections
 - Check that the connected equipment is receiving the time correctly

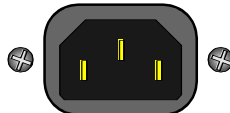
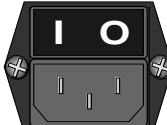
4.2 Switching on the Operating Power Supply

<p>AC power supply 3U / Table-Top / Wall:</p> 	<p>Switch on external power supply. The System 6844(RC) runs and the firmware version and programming date are shown on the display (see Chapter 4.3 Display after System Start/Reset (Firmware)).</p>
<p>AC power supply 1U:</p> 	<p>Put the mains power switch into position " I " (on). The System 6844(RC) 1U Slim Line runs and the firmware version and programming date are shown on the display (see Chapter 4.3 Display after System Start/Reset (Firmware)).</p>
<p>DC power supply:</p> 	<p>Switch on external power supply source. The System 6844(RC) 1U Slim Line runs and the firmware version and programming date are shown on the display (see Chapter 4.3 Display after System Start/Reset (Firmware)).</p>

The green Power LED resp. the power supply LED lights up for both power supplies.

4.3 Display after System Start/Reset (Firmware)

The following start frame appears on the 2x16 digit LCD-Display for approx. 3 seconds after switch-on or reset:

e.g.

S	Y	S	T	E	M		6	8	4	4					
V	0	1	.	0	0		3	1	/	M	A	Y	/	1	0

⇒ Control Board 6844 firmware
⇒ Firmware programming date

respectively

S	Y	S	T	E	M		6	8	4	4	R	C			
V	0	1	.	0	0		3	1	/	M	A	Y	/	1	0

⇒ Control Board 6844RC firmware
⇒ Firmware programming date

4.3.1 Standard Display without Valid Time

The following frame (with incremental seconds) appears on the display on **first commissioning** or a longer time **without voltage condition** and loss of backup clock information:

L	O	C		0	0	:	0	0	:	0	5		-	-	-
-	-		0	0	/	-	-	-	/	2	0	0		E	



After a voltage failure of less than 3 days the display starts up with the internal back-up clock information, provided that time information was previously available.

4.3.2 Standard Display with Valid Time

Sample frame for the standard display after system start with valid back-up clock information or following manual input of the time information:

L	O	C		1	0	:	2	5	:	1	9		D	-	C
T	U		0	1	/	J	U	N	/	2	0	1	0		M

The meaning of the individual items is as follows:

LOC 10:25:19	On adjustment: show local time on the display.
UTC 08:25:19	On adjustment: show UTC time on the display.
MO - TU - WE - TH - FR - SA - SU	Display of the weekday in abbreviated form: corresponds to MONDAY – SUNDAY
01/JUN/2010	Display of the date: Day / Month abbreviation / Year
M - S - E	Display Sync.-Mode or Errors Summary Message M -aster / S -ub Master(Slave) / E -RROR

Status display:

Position 1: X--	"D"	For daylight saving time (summer time)
	"S"	For standard time (winter time)
	"_"	The time indication on the display is set to UTC or the clock system has no valid time information
Position 2: -X-	"A"	Announcement of DST changeover (summer time / winter time changeover) to another time zone. This announcement takes place approx. 1 hour before the time zone change Announcement of a leap second . This information takes place approx. 1 hour before the insertion of the leap second.
	"_"	no announcement
Position 3: --X		Display of the internal status of the clock system:
	"_"	The clock system has no valid time information
	"C"	Clock system is running with internal quartz basis (C=Crystal)
	"r"	Clock system is synchronized via synchronisation source without internal quartz base control
	"R"	Clock system is synchronized via synchronisation source with internal quartz base control (R=Radio)



The internal time status information is calculated and the System is updated after each minute change.

4.3.3 Standard Display with Valid Time and Active ERROR-Byte

To provide the user with a visual indication of an error in the System, an E is shown on the bottom right of the display as soon as one bit in the ERROR-byte is active (see **SHOW** menu).

```
LOC 10:25:19 D-C
TU 01/JUN/2010 E
```



When the **E** is shown on the display for an active ERROR (see **SHOW menu**), the LCD-Display backlight **FLASHES** in the 1Hz pulse.

This flashing occurs on the standard display only and not on the menu images.

4.4 Keypad Functions

The following describes the keypad design and operation.

4.4.1 Keypad Layout

Keypad layout of 3U / Table-Top / Wall Systems:

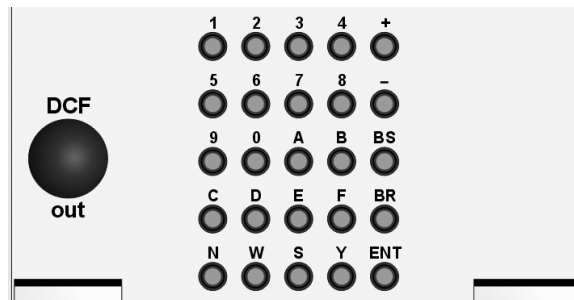

Keypad layout of 1U System:

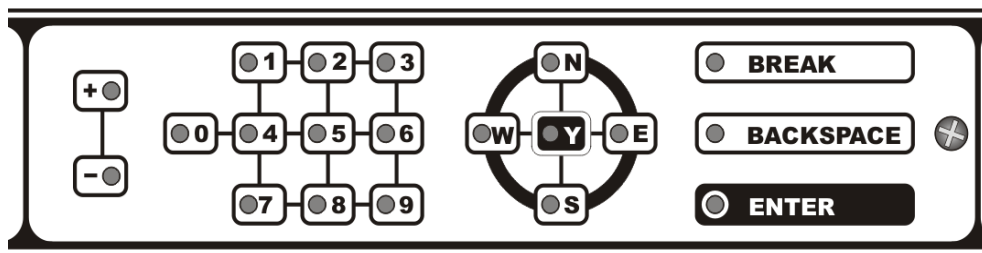

4.4.2 Key Assignment

Key	Function
+ / -	Menu layer: Key + = forward / Key - = backward Input layer: leading sign for numerical value
0 ... 9	Input of the digits
N, E, S, W	Input keys
Y	Call up menu group selection frame
BR (BREAK)	Aborts all key controls. Quits the input menu at any time and in any position. All inputs following the most recent activation of the ENT key are discarded.
BS (BACKSPACE)	Deletes the last character entered
ENT (ENTER)	Calls up the main menu from the standard display. Completes and accepts the input at the end of an input frame. When no input is made, pressing ENT switches through to the next frame.

The other buttons have no specific function.

4.4.3 Keypad Inputs / Main Menu Activation

The main menu is activated by pressing the **ENT** key. The display changes from the standard frame to the main menu:

Standard frame:

L	O	C		1	0	:	2	5	:	1	9		D	-	C
T	U		0	1	/	J	U	N	/	2	0	1	0		M

Main menu:

				S	E	T	=	1		S	H	O	W	=	2		
				S	.	C	L	K	=	3			I	N	I	=	4

- The required menu item is executed by entering the corresponding number.
- An incorrect input number is either directly refused or checked for plausibility after the **ENT** key is pressed. An "INPUT ERROR" message follows. The display then returns to the standard frame.
- All of the selection functions are not always required or used. The System functions for which they are effective are indicated in the specification, at the beginning of each sub-function. If such a function is called up by mistake this can be exited by pressing the **BR** key.

4.5 Initialization

The base initialization of the equipment is carried out first. This enables the equipment to synchronize with the Sync.-Source.

To initialize the System 6844(RC) GPS the menu items presented below are to be parameterized accordingly (see **Chapter 5.2 SET Menu - Basic Settings System 6844(RC)**). In doing so attention should be paid to System and location specific requirements such as time base, synchronization source and synchronization parameters.

Menu items required for the base parameterization:

MENU 1: #SET

- 1.01 TIME/DATE
- 1.02 DIF.-TIME
- 1.03 CHANGE_OVER DATE (Changeover Standard time / Summer time)
- 1.04 CHANGE_OVER DATE (Changeover Summer time / Standard time)
- 1.05 POSITION

MENÜ 2: #SHOW

- 2.31 SYSTEM-BYTE (Used Sync.-Source)
Shows the adjusted Sync.-Source.

All additional settings are to be carried out in accordance with the requirements and use of the equipment.

5 System Parameterization and Operation

The following describes the menu structure and the individual menus.

5.1 Menu Structure

The main menu is called up by pressing the **ENT** key. This is divided into four different menu items. These are called up by entering the respective number (1-4). Following this entry the respective sub-menus are then called up.

The menu structure is constructed as follows:

MENU 1: #SET

1.01	TIME/DATE	
1.02	DIFF.-TIME	
1.03	CHANGE_OVER DATE	(changeover standard time ⇔ summer time)
1.04	CHANGE_OVER DATE	(changeover standard time ⇔ summer time)
1.05	POSITION	(Sync.-Mode GPS only)
1.06	SYNCOFF	
1.07	COM0 - SERIALPARAMETER	
1.08	COM0 - MODE 1	
1.09	COM0 - MODE 2	
1.10	COM0 - MODE 3	(only if necessary for parameterizing)
1.11	COM1 - SERIALPARAMETER	
1.12	COM1 - MODE 1	
1.13	COM1 - MODE 2	
1.14	COM1 - MODE 3	(only if necessary for parameterizing)
1.15	LAN1 - IP-ADR	(board 7272/7273 not in system ⇔ no function)
1.16	LAN1 - GATEWAY	(----- " -----)
1.17	LAN1 - NETMASK	(----- " -----)
1.18	LAN1 - CONTROL-BYTE	(----- " -----)
1.19	LAN2 - IP-ADR	(2. board 7272/7273 not in system ⇔ no function)
1.20	LAN2 - GATEWAY	(----- " -----)
1.21	LAN2 - NETMASK	(----- " -----)
1.22	LAN2 - CONTROL-BYTE	(----- " -----)
1.23	LAN MNG - IP-ADR	(only by 6844RC with LAN MNG activated)
1.24	LAN MNG - GATEWAY	(----- " -----)
1.25	LAN MNG - NETMASK	(----- " -----)
1.26	LAN MNG - CONTROL-BYTE	(----- " -----)
1.27	FREQUENCY	(board 7530 not in system ⇔ no function)
1.28	FREQUENCY TimeON/TimeOFF	(----- " -----)
1.29	PULSE OUTPUT	
1.30	DISPLAY TIME	
1.31	LANGUAGE DAY/MONTH	
1.32	SYSTEM-BYTE	(setting Sync.-Mode)
1.33	KEYPAD KEYWORD	

MENU 2: #SHOW

2.01	ERROR-BYTE 1	
2.02	ERROR-BYTE 2	
2.03	SATELLITES	(Sync.-Mode GPS only)
2.04	POSITION	(Sync.-Mode GPS only)
2.05	DIFF.-TIME	
2.06	CHANGE_OVER DATE	(changeover standard time ⇒ daylight saving time)
2.07	CHANGE_OVER DATE	(changeover daylight saving time ⇒ standard time)
2.08	SYNCOFF	
2.09	COM0 - SERIALPARAMETER	
2.10	COM0 - MODE 1	
2.11	COM0 - MODE 2	
2.12	COM0 - MODE 3	(only if necessary for parameterizing)
2.13	COM1 - SERIALPARAMETER	
2.14	COM1 - MODE 1	
2.15	COM1 - MODE 2	
2.16	COM1 - MODE 3	(only if necessary for parameterizing)
2.17	LAN1 - IP-ADR	(board 7272/7273 not in system ⇒ no function)
2.18	LAN1 - GATEWAY	(----- " -----)
2.19	LAN1 - NETMASK	(----- " -----)
2.20	LAN1 - CONTROL-BYTE	(----- " -----)
2.21	LAN2 - IP-ADR	(2. board 7272/7273 not in system ⇒ no function)
2.22	LAN2 - GATEWAY	(----- " -----)
2.23	LAN2 - NETMASK	(----- " -----)
2.24	LAN2 - CONTROL-BYTE	(----- " -----)
2.25	LAN MNG - IP-ADR	(only by 6844RC with LAN MNG activated)
2.26	LAN MNG - GATEWAY	(----- " -----)
2.27	LAN MNG - NETMASK	(----- " -----)
2.28	LAN MNG - CONTROL-BYTE	(----- " -----)
2.29	FREQUENCY	(board 7530 not in system ⇒ no function)
2.30	FREQUENCY TimeON/TimeOFF	(----- " -----)
2.31	PULSE OUTPUT	
2.32	SYSTEM-BYTE	
2.33	ADD. OUTPUTS (1-4, if unlocked 1-8)	
2.34	ADD. INPUTS (1-4, if unlocked 1-8)	

MENU 3: #S.CLOCK

3.01	SLAVE CLOCK NO. 1-4; see Board 7406 manual (if no Board 7406 in the System ⇒ no function)
------	--

MENU 4: #INI

4.01	SHOW FIRMWARE-VERSION	
4.02	SHOW PCID (PRODUCT CONFIG ID)	
4.03	GPS MODE POS.-FIX/3D	
4.04	DCF77.SYS CONF.-BYTE	
4.05	DCF77.ADD CONF.-BYTE	(only if activated)
4.06	DCF77.SYS/(ADD) TIMEOFF	(ADD only if activated)
4.07	IRIG-B.(1) CONF.-BYTE	
4.08	IRIG-B.(1) TIMEOFF	
4.09	IRIG-B.(2) CONF.-BYTE	(only if activated)
4.10	IRIG-B.(2) TIMEOFF	(only if activated)
4.11	LAN MANAGEMENT BOARD ACTIVATION (board 6844RC only)	
4.12	RESET/DEFAULT	

5.2 SET Menu - Basic Settings System 6844(RC)

The function of this menu is to enter basic settings such as time/date, time offset, position, etc.



Grey lettering on the display corresponds to a possible customer input.

Selection screens are confirmed with (yes) or rejected with (no) or any key other than and .

After entering the next sub-function is displayed.

Use the and keys to scroll up and down on menu level.

5.2.1 Fail-safe Storage of Data Entries

All data entered via the keyboard is checked for plausibility and then stored fail-safe in an EEPROM.



Exception:

The parameters of all NTP LAN Boards available in the System and the Master Clock Board(s) (Menu 3 - S.CLK) are not stored on Control Board 6844(RC) but on the respective Function Board in each case.

5.2.2 Input Time / Date

The local time is set with this input function. The entry is made on two lines and must be complete. For this purpose it is also necessary to input the leading zeros.

Selection frame:

S	E	T		L	O	C	A	L											
T	I	M	E	/	D	A	T	E		Y	/	N							

Input frame:

T	I	M	E	>	1	5	:	4	3	:	0	0							
D	A	T	E	>	2	3	/	0	5	/	2	0	1	0					

The meaning of the individual items is as follows:

Code	Meaning	Value Range
HH	Hour	00 ... 23
MM	Minute	00 ... 59
SS	Second	00 ... 59
DD	Day	01 ... 31
MM	Month	01 ... 12
YYYY	Year	2000 ... 2099



The weekday is automatically calculated to the date

The entry is accepted by pressing the key.

In case of an incorrect input the **"INPUT ERROR"** message appears for 3 seconds. The setting function is then exited and the standard frame reappears on the display.

If further entries are required, any key except **Y** and **BR** can be pressed to switch through the **SET** menu.

The setup program is exited by pressing the **BR** key. The standard frame reappears.

The changeover dates for daylight saving time are to be entered for countries which change their time zone during the year.

5.2.3 Input Local Time to UTC Time Offset (Time Zone)

The time offset between the local standard time and the world time (UTC time) is entered with this function.

Selection frame:

S	E	T		D	I	F	F	.	-	T	I	M	E
(T	I	M	E	Z	O	N	E)		Y	/	N

Input frame:

				D	I	F	F	.	-	T	I	M	E		
				>	+	0	1	:	0	0	<				

Difference Time Europe (CET)

The operational sign indicates the direction in which the local time differs from the world time:

- '+' Corresponds to East of the Null Meridian (Greenwich)
- '-' Corresponds to West of the Null Meridian (Greenwich)

Since most countries of the world count their time offset in whole hours, the input is also in one hour steps. The difference time may be up to ± 14.00h.

e.g. + 05:00 or - 11:00

However, some countries also use smaller time intervals. Therefore it is also possible to input the data in one minute steps:

e.g. + 05:30 or - 08:45

The time offset always relates to the **local standard time (winter time)**, even if commissioning or input of the time offset takes place during daylight saving time.

Standard time (winter time)	⇒	adjusted diff.-time
Daylight saving time (DST)	⇒	adjusted diff.-time +1h

Example for Germany:

UTC	Local Time	Time offset to be set:	Comment
13:00:00	14:00:00 (winter time)	+01:00	
13:00:00	15:00:00 (Daylight Saving Time (DST))	+01:00	The time offset of two hours is made up of +01:00h time offset and +01:00h for the daylight saving time offset (changeover points of time must be set for this purpose).

5.2.4 Input Daylight Saving Time (DST) Changeover

This input is used to define the points of time at which the changeover is made to daylight saving time (DST) or to standard time throughout the course of the year. The hour, weekday, week of the month and month in which the daylight saving time (DST) changeover (daylight saving time / standard time changeover) is to take place are given here. The exact points of time are then calculated automatically for the current year.



After the turn of the year the switching times for daylight saving time and winter time are automatically calculated by the Clock System, which do not require any user interaction.

The parameters are selected in such a way that the changeover can take place at any point of time. For control purposes, the exact date for the current year is indicated in the **SHOW** functions.

If the DST changeover is **not** to be activated all values have to be entered as 0. The System 6844(RC) then only operates with the standard time (winter time) set via the time offset.

Selection frame:

S	E	T		C	H	A	N	G	E	_	O	V	E	R	
D	A	T	E	S	-	>	D		Y	/	N				

 For winter / summer time changeover
(Standard time \Rightarrow Daylight saving time)

Input frame:

S	-	>	D		h	h	/	d	/	w	/	M	M		
					>	0	2	/	7	/	5	/	0	3	<

Selection frame:

S	E	T		C	H	A	N	G	E	_	O	V	E	R	
D	A	T	E	D	-	>	S		Y	/	N				

 For summer / winter time changeover
(Daylight saving time \Rightarrow Standard time)

Input frame:

D	-	>	S		h	h	/	d	/	w	/	M	M		
					>	0	3	/	7	/	5	/	1	0	<

The meaning of the individual items is as follows:

hh	The hour in which the changeover is to take place	00 ... 23 hours
d	The weekday on which the changeover is to take place	1 = Mo ... 7 = Su
w	the appearance of weekday in the month on which the changeover is to take place	1 ... 4 \Rightarrow 1.-4. appearance 5 \Rightarrow last appearance in the month
MM	The month in which the changeover is to take place	

The entry is completed by pressing the **ENT** key.

Input example for Germany (CET/CEST):

Standard time (CET) ⇒ DST (CEST) at the 2nd hour on the last Sunday in March.

Input: 02/7/5/03

Changeover standard time ⇒ DST (daylight saving time)

Local time	UTC	Offset UTC ⇒ local time
01:59:58	00:59:58	+1 hour
01:59:59	00:59:59	+1 hour
03:00:00	01:00:00	+2 hours
03:00:01	01:00:01	+2 hours

DST (CEST) ⇒ Standard time (CET) at the 3rd hour on the last Sunday in October.

Input: 03/7/5/10

Changeover DST (daylight saving time) ⇒ standard time

Local time	UTC	Offset UTC ⇒ local time
02:59:58	00:59:58	+2 hours
02:59:59	00:59:59	+2 hours
02:00:00	01:00:00	+1 hour
02:00:01	01:00:01	+1 hour

5.2.5 Input Position (GPS only)

The geographical position of the equipment is entered with this function. This function is helpful during the first commissioning and shortens the first synchronization of the GPS receiver.

Selection frame:

S	E	T	P	O	S	I	T	I	O	N		
			Y	/	N							

Input frame:

L	T	.	N	5	1	°	1	2	,	6	9	0	0	'	
L	N	.	E	0	0	7	°	3	9	,	7	9	0	0	'

position of the **hopf** company

The entries for the latitude and longitude positions take place in degrees and minutes and seconds.



After entering the position the Systems sets the two last digits automatically to "00".

The operational sign for the degrees of latitude - **LT.** is:

- N** Northern hemisphere
- S** Southern hemisphere

and for the degrees of longitude - **LN.**:

- E** East of the Null Meridian (Greenwich)
- W** West of the Null Meridian (Greenwich)

The latitude position is entered first under **PGG°MM,SSSS**, where the meanings are as follows:

- P** N or S, North or South
- GG** Degrees of **Latitude** from 00 - 89
- MM** Minutes of **Latitude** from 00 - 59
- SSSS** Minutes of **Latitude** decimal places 0000 - 9999

There then follows the entry of the longitude position under **pGGG°MM,SSSS**, where the meanings are as follows:

p	E or W, East or West	
GGG	Degrees of Longitude from	000 - 179
MM	Minutes of Longitude from	00 - 59
SSSS	Minutes of Longitude decimal places	0000 - 9999

The position of **hopf** Elektronik GmbH is given in the above example.

The entry is completed by pressing the **ENT** key.

In order to speed up the synchronization of the GPS receiver it is sufficient for the position to be input to an accuracy of 1-2 degrees (without minutes or decimal places).



If the position is unknown **0** should be entered in all places and **N** and **E** for the direction.



If the position is incorrectly set and the GPS receiver synchronizes with this position in the Position-fix mode, there may be a time leap under sync. status "R" if, in the meantime, the GPS receiver picks up enough satellites to calculate its correct position.

5.2.6 Input SyncOFF Timer - Delayed Change of Sync.-Status

This value is used to bridge reception failures for error message-free operation in difficult reception conditions.

In the event of reception failure of the synchronization source, System synchronization to Quartz Status 'C' is delayed by the set value. During this time, the System continues to run in synchronization status 'r' on the internal, high-precision regulated quartz basis.

This timer is of particular importance when certain System outputs are linked to a specific System status.

The timer can be adjusted from 2min. to 99h and 59min.

Selection frame:

S	E	T	S	y	n	c	O	F	F	
T	I	M	E	R				Y	/	N

Input frame:

S	y	n	c	O	F	F	>	h	h	:	m	m	<
							>	9	9	:	5	9	<

Default value : 00:55

The desired value is entered via the keyboard. The input is accepted by pressing the **ENT** key.



The associated **SHOW menu** can display whether the SyncOFF timer is active and the current value of the timer.

5.2.7 Input Serial Interface Parameters

The interface parameters and the output mode can be entered separately for each of the two serial interfaces. The following selection frames will be displayed (for configuration see **Chapter 6 COM0 / COM1 Serial Interfaces**).



Using the COM0 interface as Remote-Interface (RC Systems) and COM1 interface as synchronisation interface (Sub-Master Systems) the interfaces are not available for any other functions.

5.2.7.1 Selection Frames for Parameters of Serial Interface COM0

Setting serial Parameter

Selection frame:

S	E	T	C	O	M	0	S	E	R	I	A	L
P	A	R	A	M	E	T	E	R	Y	/	N	

The parameters for **B**aud rate, **W**ord length, **P**arity bit and **S**top bit must be entered in sequence in the following input frame:

Input frame:

B	d	:	0	9	6	0	0	W	:	8		
P	:	N	S	:	1							_

Setting Mode Byte 1

Selection frame:

			S	E	T	C	O	M	0						
			M	O	D	E	B	Y	T	E	_	1	Y	/	N

Input frame:

M	o	d	B	_	1	7	6	5	4	3	2	1	0	
C	O	M	0			>	1	1	0	0	1	1	0	0

Setting Mode Byte 2

Selection frame:

			S	E	T	C	O	M	0						
			M	O	D	E	B	Y	T	E	_	2	Y	/	N

Input frame:

M	o	d	B	_	1	7	6	5	4	3	2	1	0	
C	O	M	0			>	1	1	1	0	1	1	0	0



Depending on the selected string, **Mode Byte 3** is also available in the menu for the required configuration of the string.

Setting Mode Byte 3

Selection frame:

			S	E	T	C	O	M	0						
			M	O	D	E	B	Y	T	E	_	3	Y	/	N

Input frame:

M	o	d	B	_	3	7	6	5	4	3	2	1	0	
C	O	M	0			>	0	0	0	0	0	0	0	1

5.2.7.2 Selection Frames for Parameters of Serial Interface COM1

S	E	T		C	O	M	_	1		S	E	R	I	A	L
P	A	R	A	M	E	T				Y	/	N	_		

The parameters for the COM1 interface are entered in the same way as for COM0.



The parameter settings have no effect on the serial interface COM1 in case of synchronisation of System via serial interface by the **hopf** Master/Slave string. At this, the parameters are firmly adjusted to 9600baud, 8 data bit, no parity and 1 stop bit.



Received data on the serial interface that are not specified in the pertinent data string might disturb and interrupt the cyclic string output. The receiving synchronization interface should be set to "transmitting on request" for Sub-Master (Slave) Systems.

5.2.8 Input LAN Board Parameters (Option)

Further information and an explanation of the parameters are available in the respective LAN Board description.

5.2.8.1 Selection Frames for LAN Board 1 Parameters



After configuring LAN_1 the data input **must** be confirmed with **ENT** and the SET menu must be left with **BR** for data acquisition.

Setting the IP address

Selection frame:

S	E	T		L	A	N	_	1							
I	P	-	A	D	R	.				Y	/	N			

Input frame:

L	A	N	_	1		I	P	-	A	D	R	.			
>	1	9	2	.	1	6	8	.	2	0	2	.	2	1	0

Setting the Gateway address

Selection frame:

S	E	T		L	A	N	_	1							
G	A	T	E	W	A	Y	-	A	D	R	.		Y	/	N

Input frame:

L	A	N	_	1		G	W	-	A	D	R	.			
>	1	9	2	.	1	6	8	.	2	0	2	.	0	1	0

Setting the Network Mask

Selection frame:

S	E	T		L	A	N	_	1							
N	E	T	M	A	S	K				Y	/	N			

Input frame:

L	A	N	_	1		N	E	T	M	A	S	K			
>	2	5	5	.	2	5	5	.	2	5	5	.	0	0	0

Setting the Control Byte

Selection frame:	SET LAN_1								
	CTRL.-BYTE	Y/N							
Input frame:	CTRL.-B	7	6	5	4	3	2	1	0
	LAN_1	>	0	0	0	0	0	0	0

5.2.8.2 Selection Frames for LAN Board 2 Parameters



After configuring the LAN_2 the data input **must** be confirmed with **ENT** and the SET menu must be left with **BR** for data acquisition.

Selection frame:	SET LAN_2								
	IP-ADR.	Y/N							

This display frame shows the configuration of the LAN Board coded as Board 2 (if available in the System).

The parameters for LAN Board 2 are entered in the same way as for LAN Board 1.

5.2.8.3 Selection Frame Parameters of the LAN Management Board/Module (System 6844RC only)



After configuring the LAN_MNG the data input **must** be confirmed with **ENT** and the SET menu must be left with **BR** for data acquisition.



The menu is only visible on System 6844RC when the LAN Management Board / Module is activated.
The LAN Management Board / Module is activated in the **INI Menu**.

Setting the IP address

Selection frame:	SET LAN_MNG								
	IP-ADR.	Y/N							
Input frame:	LAN_MNG	IP-ADR.							
	>	192	.	168	.	202	.	210	

Setting the Gateway address

Selection frame:	SET LAN_MNG								
	GATEWAY-ADR.	Y/N							
Input frame:	LAN_MNG	GW-ADR.							
	>	192	.	168	.	202	.	210	

Setting the Network Mask

Selection frame:

S	E	T	L	A	N	_	M	N	G			
										Y	/	N

Input frame:

L	A	N	_	M	N	G		N	E	T	M	A	S	K	
>	1	9	2	.	1	6	8	.	2	0	2	.	2	1	0

Setting the Control Byte

Selection frame:

S	E	T	L	A	N	_	M	N	G				
											Y	/	N

Input frame:

C	T	R	L	.	-	B		7	6	5	4	3	2	1	0
L	A	N	_	M	N	G	>	1	0	1	0	0	0	0	1

5.2.9 Input Frequency Output (Option)

When the System is extended with the Frequency Output Board, the frequency output can be set between 1Hz and 10MHz in steps of 1Hz using this function.

The input mode is explained in the description of the Frequency Output Board.

Frequency Input

Selection frame:

S	E	T	F	R	E	Q	U	E	N	C			
											Y	/	N

Input frame:

F	R	E	Q	U	E	N	C	,		H	Z	
>	1	0	.	0	0	0	.	0	0	0	H	Z

 ⇔ corresponds to 10MHz

Frequency Output Delay

Selection frame:

S	E	T	F	R	E	Q	U	E	N	C														
											T	i	m	e	O	N	/	O	F	F		Y	/	N

Input frame:

T	i	m	e	O	N	/	O	F	F	,		m	i	n
>	0	0	0	/	0	0	2	<						

The output behaviour of the Frequency Board can be defined with **TimeON** and **TimeOFF**.

The **TimeON** timer defines how long the System has to run in synchronization status "R" before the output is enabled. This setting can be used to ensure that the base System is in a precisely regulated state.

The **TimeOFF** timer can be used to define how long the transmission should continue although the System has changed synchronization status from "R" to "C".

Timer	Input values
TimeON	0 .. 255min.
TimeOFF	2 .. 255min.



This function is not available via the Remote-Interface (**hmc**) in RC-Systems.

5.2.10 Input Status and Pulse Output

A programmable output is available on the internal connector (pin **8C**) which can be assigned with status message, cyclical pulse or DCF77 pulse (1 Hz).



The setting must not be changed by 1U devices; otherwise the status output of the status LEDs and error relays will be faulty. Set value for 1U Systems = 0000 0001

Programming takes place by entering a byte. The input is selected with the following selection frame:

Pulse configuration

Selection frame:

		S	E	T	P	U	L	S	E		
		O	U	T					Y	/	N

Input frame:

P	U	L	S	E			7	6	5	4	3	2	1	0
B	Y	T	E				>	0	0	0	0	0	0	0

⇔ Reference value for 1U

In the second line, the individual bits can now be set to "0" or "1", whereby "1" is to be seen as a start-up function.

The meanings of the individual bits are as follows:

B7	Pulse Level Direction
0	Not inverted (⇒ low active)
1	Inverted (⇒ high active)



- If all bits in Mode 1, 2 and 3 are set to "0" (zero), Modes are disabled ⇒ there is no output on the pulse output.
- After disabling the Modes, it is recommended to trigger a program re-set.



- Only one Mode can be enabled.
- Enabling of several Modes is prohibited. In the event of a prohibited configuration there is no output on the pulse output.
- If a function is set in the corresponding Mode, the bits of the other Modes must be set to "0" (zero).

The following selections are available:

Display	Input
German	0
English	1

5.2.13 Input SYSTEM-Byte

Functions can be switched on and off with the individual bits in the System byte.

Selection frame:	<table border="1"> <tr> <td>S</td><td>E</td><td>T</td><td>S</td><td>Y</td><td>S</td><td>T</td><td>E</td><td>M</td><td>B</td><td>Y</td><td>T</td><td>E</td> </tr> <tr> <td></td><td></td><td></td><td></td><td></td><td></td><td></td><td></td><td></td><td></td><td></td><td>Y</td><td>N</td> </tr> </table>	S	E	T	S	Y	S	T	E	M	B	Y	T	E												Y	N		
S	E	T	S	Y	S	T	E	M	B	Y	T	E																	
											Y	N																	
Input frame:	<table border="1"> <tr> <td>S</td><td>Y</td><td>S</td><td>T</td><td>E</td><td>M</td> <td>7</td><td>6</td><td>5</td><td>4</td><td>3</td><td>2</td><td>1</td><td>0</td> </tr> <tr> <td>B</td><td>Y</td><td>T</td><td>E</td> <td>></td><td>0</td><td>0</td><td>0</td><td>0</td><td>0</td><td>0</td><td>0</td><td>0</td><td>0</td> </tr> </table>	S	Y	S	T	E	M	7	6	5	4	3	2	1	0	B	Y	T	E	>	0	0	0	0	0	0	0	0	0
S	Y	S	T	E	M	7	6	5	4	3	2	1	0																
B	Y	T	E	>	0	0	0	0	0	0	0	0	0																

⇒ Sync.-Mode GPS

In the second line only "0" or "1" can be set for the individual bits whereby "1" is considered as switch-on function.



Unused bits should be set to "0" for compatibility reasons.

B7	free, not used at present
B4	free, not used at present
B3	free, not used at present

5.2.13.1 Service Function for the GPS-Module-Update (via COM0) – Bit 6

A service function for a GPS Module update on interface COM0 can be activated by bit 6.

This service function is deactivated by default and will be deactivated **only** after a reset.

B6	Service function for GPS-Module-Update (via COM0)
0	disabled (only after a system reset)
1	activated



When this function has been activated:

- There is no synchronization via GPS possible.
- The interface COM0 can only be used for the GPS-Module-Update.
- No GPS data in the system such as satellites/position are updated (frozen data are displayed)
- In the ERROR-Byte the bits 1 and 0 are set to 1 by the system

5.2.13.2 Test mode - Simulation system status "synchronous - R" – Bit 5

The test mode can be enabled by bit 5 which simulates the internal condition of the clock system "synchronous - R". All system outputs behave the same as in a completely synchronized system. For the activation a plausible system time is needed (internal condition of the clock system C, r or R).

The system 6844(RC) is not synchronized by the connected sync sources when the simulation is activated. There is no new time input approved via the keypad, display, or remote.

The enabled simulation is signalized in the ERROR-Byte (see **Chapter 5.3.1 ERROR-Byte**).

For the termination of this simulation the System 6844(RC) must be restarted e.g. via hardware reset or turning off and on the system voltage.

The service function is deactivated by default.

B5	Test mode - Simulation system status "Synchronous – R"
0	disabled (by default)
1	activated



Connected systems cannot distinguish between **simulated** and **real system status "synchronous - R"**.

5.2.13.3 Synchronization Mode (Sync.-Mode) – Bit 0-2

B2	B1	B0	Sync.-Source
0	0	0	GPS - (Master) System synchronization via GPS
0	0	1	Serial Interface (COM1) - (Sub-Master (Slave)) Synchronization via serial hopf Master/Slave-String
0	1	0	Serial Interface (COM1) + PPS - (Sub-Master (Slave)) Synchronization via serial hopf Master/Slave-String with additional PPS
0	1	1	DCF77 Pulse (CET) - (Sub-Master (Slave)) Synchronization via DCF77 pulse
1	0	0	DCF77 Pulse (worldwide) - (Sub-Master (Slave)) Synchronization via DCF77 pulse
1	0	1	free, currently GPS
1	1	0	Special Sync. via serial interface with LOCAL time (FE1000) Serial Interface (COM1) - (Sub-Master (Slave)) Synchronization is processed via a serial hopf Master/Slave-String: <ul style="list-style-type: none"> - Time basis of the synchronization signal: Local Time - The difference time can be freely adjusted in the system (independent from IRIG-B signal) - The summer-/winter time switch-over is processed by the switching points set in the system so far they have been entered (independent from IRIG-B signal)
1	1	1	Special Sync. via serial interface with UTC time (FE1000) Serial Interface (COM1) - (Sub-Master (Slave)) Synchronization is processed via a serial hopf Master/Slave-String: <ul style="list-style-type: none"> - Time basis of the synchronization signal: UTC - The difference time can be freely adjusted in the system (independent from IRIG-B signal) - The summer-/winter time switch-over is processed by the switching points set in the system so far they have been entered (independent from IRIG-B signal)

For further information see **Chapter 2 System 6844(RC) Synchronization**.



The Sync.-Mode is not changed or reset by releasing a FACTORY DEFAULT.

5.2.14 Keyword Function for Keypad

The System can be protected by a key-word against unauthorized changes via the keypad to the settings.



Warning: In the case of Systems 6844, if the keyword is lost this can only be reset at the *hopf* factory.

In 6844RC Systems, the keyword for the keyboard can be reset by triggering a factory default via the remote interface.



In order to avoid delays during commissioning, the keyword should only be set after commissioning has been completed. The keyword should be kept in a safe place and protected against unauthorized access.

If a keyword has been set then this is requested after a selection has been made from the main menu.

If the keyword is entered correctly then the display changes to the selected menu. The keyword protection is then deactivated until the selected menu has been exited. The keyword protection is automatically reactivated after exiting the menu by pressing **BR** or after 255 seconds without pressing a key.

No keyword is set up in the factory.

Selection frame:

		S	E	T		K	E	Y	P	A	D		
		K	E	Y	W	O	R	D		Y	/	N	

Input frame:

S	E	T	/	E	N	T	E	R						
K	E	Y	W	O	R	D			>	7	2	5	9	<

A 4 digit number can now be entered as the keyword. The entry must be completed by pressing the **ENT** key. The number sequence **0000** is an exception.

Input frame:

S	E	T	/	E	N	T	E	R						
K	E	Y	W	O	R	D			>	0	0	0	0	<

With this sequence of numbers the current keyword (if set) **is deleted** and the keyword protection is deactivated.

The keyword becomes active when the next selection is made from the main menu.

Input frame:

K	E	Y	-	W	O	R	D		>	*	*	*	*	<
---	---	---	---	---	---	---	---	--	---	---	---	---	---	---

A star is displayed for each digit entry and is always automatically completed by an arrow after the fourth entry.

The keyword is confirmed by pressing the **ENT** key. If the keyword is correct entry is gained to the corresponding menu item.

Error Bit 4 = 1 (incomplete data set for daylight saving time (DST) changeover)

The data for the daylight saving time (DST) changeover were not entered in full. There is no calculation possible

Error Bit 3 = 1 (Error when writing in the EEPROM)

After multiple writing of the data in the EEPROM the verification failed. An error-free system functionality cannot be guaranteed. The system remains in sync status 'C' (crystal) because of this mistake.

Error Bit 2 = 1 (Error in the adjustment of the quartz frequency)

There is an error in the internal adjustment of the quartz frequency. The specified system accuracy and freewheel stability can't be guaranteed. According to these error the system stays in Sync.-Status 'C' (crystal).

Error bit 1 = 1 (Protocol / Time information of the Sync.-Source is not plausible)

The protocol being read or rather the time information of the Sync.-Source cannot be evaluated nor used.

By default the error bit "Sync.-Protocol" is always set after a system reset. After system start the error bit is set or rather cancelled according to the received Sync.-Protocol. This error bit is separately operated for each Sync.-Mode. All used Sync.-Protocols of the respective Sync.-Mode may cause the setting of this failure bit.

Below the behaviour of the quality counter and the single Sync.-Modes are described:



The respective quality counter verifies the received Sync.-Protocol to the following scheme **every second**:

Value range of the quality counter: 0-60

Quality counter +1 ⇒ all verifications are POSITIVE

Quality counter -5 ⇒ at least one verification is NEGATIVE

After a system reset:

Initial value of the quality counter = 0

Value of the quality counter = 0-30 ⇒ **Error in the Sync.-Protocol**

If the quality counter has been >30 one time during operation:

Quality counter = 0 ⇒ **Error in Sync.-Protocol**

Quality counter ≠ 0 ⇒ **No error in Sync.-Protocol**

Sync.-Mode GPS**Serial String (Interval = every second)**

The internal string is controlled once per second for:

- Plausibility of the strings structure
- Plausibility of the time information
- Existence of a VISIBLE error (see menu SHOW Satellites)

All criteria of the string are met, the quality counter is raised;
at least one not met criteria leads to a countdown of the counter.

PPS (Interval = every second)

The PPS is controlled once per second for:

- The next PPS follows within 1000msec ±10msec
- Deviation of the pulse width of the PPS is max. ±40msec compared to the recent PPS
- The pulse width of the PPS is max. 800msec

All criteria of the string are met, the quality counter is raised;
at least one not met criteria leads to a countdown of the counter.

Sync.-Mode *hopf* Master/Slave

Serial String (Interval = every second or minute)

The internal string is controlled once per second respectively once per minute for:

- Plausibility of the strings structure
- Plausibility of the time information

All criteria of the string are met, the quality counter is raised;
at least one not met criteria leads to a countdown of the counter.



Every minute protocols **do not use a quality counter**. Here the error bit can be set every minute or cancelled depending on the result of the verification.



Received data on the serial interface that are not specified in the pertinent data string might disturb and interrupt the cyclic string output. The receiving synchronization interface should be set to "transmitting on request" for Sub-Master (Slave) Systems.

Sync.-Mode *hopf* Master/Slave with PPS

Serial String (Interval = every second or minute)

The internal string is controlled once per second for:

- Plausibility of the strings structure
- Plausibility of the time information

All criteria of the string are met, the quality counter is raised;
at least one not met criteria leads to a countdown of the counter.



Every minute protocols **do not use a quality counter**. Here the error bit can be set every minute or cancelled depending on the result of the verification.

PPS (Interval = every second)

The PPS is controlled once per second for:

- The reception cycle is within 1000msec \pm 10msec
- Max. deviation of the pulse width \pm 40msec
- Pulse width max. 800msec

All criteria of the string are met, the quality counter is raised;
at least one not met criteria leads to a countdown of the counter.

Sync.-Mode DCF77 Pulse (CET and worldwide)

DCF77 pulse (Interval = every minute)

The DCF77 time telegram is controlled once per second for:

- Plausibility of the strings structure
- Plausibility of the time information
- Plausibility of pulse length
 - DCF77 pulse low = 100msec. \pm 20msec.
 - DCF77 pulse high = 200msec. \pm 20msec.



Every minute protocols **do not use a quality counter**. Here the error bit can be set every minute or cancelled depending on the result of the verification.

Error bit 0 = 1 (no signal on the adjusted Sync.-Channel (input))

On the input of the adjusted Sync.-Source no signal nor activity is detected.

By default the error bit "Sync.-Channel" is **not** set after a System reset.

After system start the error bit is set or rather cancelled according to the activity on the Sync.-Channel. This error bit is separately operated for each Sync.-Mode. All used Sync.-Channels of the respective Sync.-Mode may cause the setting of a failure bit.

Based on no activity on a used Sync.-Channel, the error bit "Sync.-Channel" is set at the end of the **Sync.-Channel - Time OUT**. Each detected activity on this Sync.-Channel resets the Sync.-Channel - TimeOUT and thus the error bit.

Sync.-Mode	Sync.-Channel	Sync.-Channel - TimeOUT
GPS	Serial String	181 seconds
	PPS	61 seconds
hopf Master/Slave	Serial String	181 seconds
hopf Master/Slave with PPS	Serial String	181 seconds
	PPS	61 seconds
DCF77 pulse (CET and worldwide)	DCF77 Pulse	25 seconds

5.3.2 ERROR-Byte 2

Erroneous functions or modules are displayed in the ERROR-Byte for faster fault analysis. Logic "0" indicates that the function or module is operating perfectly. Logic "1" indicates that there is a fault condition.

Selection frame:

S	H	O	W	E	R	R	O	R	B	Y	T	E	_	2	
													Y	/	N

Display frame:

E	R	R	O	R		7	6	5	4	3	2	1	0		
B	Y	T	E	_	2	>	0	0	0	0	0	0	0	0	0

At present the following bits are allocated in the Error Byte:

B7-2	Without function at present
0	no error
1	Without function at present
B1	Redu Power Supply 2
0	no error
1	Error Redu Power Supply 2
B0	Redu Power Supply 1
0	no error
1	Error Redu Power Supply 1

Error-bit 1 (option) = Redu Power Supply 2 Error

There is an error in the Redu Power Supply 2. Redu Power Supply 2 is not available as power supply.



The verifying of the Redu Power Supply ex stand "H8 program version 06.00" is available.

Error-bit 0 (option) = Redu Power Supply 1 Error

There is an error in the Redu Power Supply 1. Redu Power Supply 1 is not available as power supply.



The verifying of the Redu Power Supply ex stand "H8 program version 06.00" is available.

5.3.3 Satellite Values (GPS only)

This display function indicates the number of satellites that theoretically lie in the visibility range of the antenna (V - visible); the actual number of received satellites (T - tracked); the satellites that are being received (PRN - satellite no.) and a relative measurement of reception performance.

This information is particularly helpful during installation and analysis of synchronisation problems (see **Chapter 9 System Indicators / Fault Analysis / Troubleshooting**).

If the System is set for 3D synchronization it is necessary for a minimum of four satellites to be in the visibility range of the antenna (tracked) in order to synchronize the GPS System 6844(RC) with UTC and to calculate the position. Under optimum conditions approx. 9-14 satellites are in the visibility range of the antenna, of which 12 can be received in parallel.

In the Position-fix mode at least one satellite is required for synchronization (however the position is not calculated in this case).

Selection frame:

SHOW SATELLITES											
											Y/N

If values are available in the System then the display frame may appear as follows (example):

Display frame 1:

V	20	:	095	13	:	090					
10	07	:	077	25	:	075					

Display frame 2:

T	10	:	068	03	:	063					
07	17	:	051		:						

10 satellites are theoretically within visibility range, of which satellite 20 is captured by the GPS receiver with a relative signal/noise ratio of 95 and satellite 7 with a relative signal/noise ratio of 77, etc.

A maximum of eight satellites can be shown on the display. This takes place on two frames which are shown alternately **every three seconds**.



The **Y** key can also be used to manually switch between these two frames.

V (visible)

The number of satellites which are visible at this location with a theoretically optimum antenna position appears under **V** (visible). During the first reception process or after a lengthy voltage failure the value **00** appears under **V**.

Visible Value **0-14** is the number of satellites that can theoretically be picked up under optimum reception conditions, as calculated by the GPS receiver.

In addition, Visible Value **15-19** can represent an error message from the GPS receiver, if required. The error message output changes every second between "**V = 0**" and "**V = error message**".



If there are no figures under **V** ⇒ there is a fault on the GPS receiver.

T (tracked)

T (tracked) shows the number of satellites that the System is actually receiving.



The situation may temporarily arise that, due to an unfavourable constellation, the receiver may well pick up satellites that cannot however be used to calculate the highly accurate time information. In such cases, it may occur that an adequate number of satellites are received but **synchronization of the System does not take place**.

Pseudo-Random-Number

The figure before the colon is the Satellite Pseudo Random Number. The satellites are not identified by 1, 2, 3 etc. but by the Pseudo Random Number under which the satellite radiates its information. If a satellite fails a reserve satellite can be activated under the same number.

Signal/Noise Ratio

The number after the colon indicates the signal/noise ratio as a relative value. This should vary between 0 and max. 110.

After the first installation it can take up to 30 minutes under the most unfavourable conditions until anything is presented on the display frame. This is dependent on the start information which the System receives (see Input Time, Position etc.) as well as the antenna position, e.g. no free antenna visibility to the sky.

Meaning of the Display Values	Signal/Noise Ratio
No satellite received	~~~
Under poor signal/noise conditions the values lie between resp. are not shown	000 - 030
Under satisfactory to good signal/noise conditions the values lie between	033 - 048
Under very good signal/noise conditions the values are	≥ 051

5.3.4 Position (GPS only)

The input position of the equipment (antenna) or the position updated by GPS is shown on this display frame. The position data is updated by GPS every second (the display frame is only updated after the menu item has been called up again or by pressing Y).

Selection frame:

S	H	O	W	P	O	S	I	T	I	O	N				
												Y	/	N	

Display frame:

L	T	.	N	5	1	°	1	2	,	6	9	9	3	'	
L	N	.	E	0	0	7	°	3	9	,	7	9	9	4	'

LT = Degree of latitude, LN = Degree of longitude

In the above example the position of **hopf**Elektronik GmbH is displayed.

5.3.5 Time Offset (Time Zone)

This display frame can be used to view the currently set time offset between local standard time (time zone) and UTC time.

Selection frame:

S	H	O	W	D	I	F	F	.	-	T	I	M	E
(T	I	M	E	Z	O	N	E)	Y	/	N	

After entering Y the following image is displayed, e.g.:

Display frame:

				D	I	F	F	.	-	T	I	M	E		
				>	+	0	1	:	0	0	<				



Only the pre-set time offset to the local standard time (winter time) is ever displayed. No account is taken of any additional offset due to summer time.

5.3.6 Daylight Saving Time (DST) Changeover

The DST changeover points of time for the current year, calculated from the customer input, can be viewed with this display frame.



After a year change the clock system automatically recalculates the daylight saving time changeover points of time.

Time Zone Changeover S ⇒ D

This function shows the changeover point of time from **Standard** time (winter time) to **Daylight** saving time (summer time).

Selection frame:

S	H	O	W	C	H	A	N	G	E	O	V	E	R
D	A	T	E	S	-	>	D	Y	/	N			

After entering Y the following frame appears (example):

Display frame:

S	-	>	D	T	I	M	E	>	0	2	:	0	0					
				S	U				2	8	/	0	3	/	2	0	1	0

The changeover takes (took) place on Sunday 28 March 2010 at 02.00 a.m.

Time Zone Changeover D ⇒ S

This function shows the changeover point of time from Daylight saving time (summer time) to Standard time (winter time).

Selection frame:

S	H	O	W		C	H	A	N		O	V	E	R
	D	A	T	E		D	-	>	S		Y	/	N

After entering Y the following frame appears (example):

Display frame:

D	-	>	S		T	I	M	E		>	0	3	:	0	0
	S	U		3	1	/	1	0	/	2	0	1	0		

The changeover takes (took) place on Sunday 31 October 2010 at 03.00 a.m.

If no changeover dates are set in the System, the following frame appears in response to both requests:

Display frame:

N	O		C	H	A	N	G	E		O	V	E	R
			D	A	T	E							

5.3.7 SyncOFF Timer - Delayed Change of Sync. Status

The current value set for the SyncOFF timer can be viewed with this display frame.

Also displayed is whether the SyncOFF timer is enabled and, if so, the remaining time until the timer expires and thus until the System synchronization status changes if no new synchronization was carried out up to this point of time.

Selection frame:

S	H	O	W		S	y	n	c	O	F	F					
	T	I	M	E										Y	/	N

After entering Y the following image is displayed, e.g:

Display frame:

S	y	n	c	O	F	F		x	=	h	h	:	m	m
A	=	0	0	:	5	0		S	=	0	1	:	0	0

This display frame means that the SyncOFF timer was set to one hour and that this timer is active and will run for a further 50 minutes.

The timer is enabled as soon as the System ceases to be synchronized by the synchronization source. Dependent on the synchronization source, the timer can then countdown to 00:00 in order to then lower the System status from "r" to "C"; alternatively it is again disabled if re-synchronization takes place by the synchronization source (see the following display frames).

Display frame:

S	y	n	c	O	F	F		x	=	h	h	:	m	m
A	=	-	-	:	-	-		S	=	0	1	:	0	0

 Timer not active

Display frame:

S	y	n	c	O	F	F		x	=	h	h	:	m	m
A	=	0	0	:	0	0		S	=	0	1	:	0	0

 Timer lapsed

5.3.8 Serial Interface Parameters

With this menu the serial interface parameters can be shown.

5.3.8.1 Display Frames for the COM0 Serial Interface Parameters

The configuration of the COM0 interface is shown with these display frames. The significance of the configuration can be found in **Chapter 6 COM0 / COM1 Serial Interfaces**.

COM 0 Interface Parameter Displays

Selection frame:

S	H	O	W	C	O	M	0	S	E	R	I	A	L
P	A	R	A	M	E	T	E	Y	/	N			

Display frame:

B	d	:	0	9	6	0	0	W	:	8			
P	:	N	S	:	1								

Mode Byte 1 Displays

Selection frame:

		S	H	O	W	C	O	M	0					
		M	O	D	E	B	Y	T	E	_	1	Y	/	N

Display frame:

M	o	d	B	_	1			7	6	5	4	3	2	1	0
C	O	M	0					>	1	1	0	0	0	0	0

Mode Byte 2 Displays

Selection frame:

		S	H	O	W	C	O	M	0					
		M	O	D	E	B	Y	T	E	_	2	Y	/	N

Display frame:

M	o	d	B	_	2			7	6	5	4	3	2	1	0
C	O	M	0					>	0	0	0	0	1	1	0



Depending on the selected string, **Mode Byte 3** is also available in the menu for the required configuration of the string.

Mode Byte 3 Displays

Selection frame:

		S	H	O	W	C	O	M	0					
		M	O	D	E	B	Y	T	E	_	3	Y	/	N

Display frame:

M	o	d	B	_	3			7	6	5	4	3	2	1	0
C	O	M	0					>	0	0	0	0	0	0	0

5.3.8.2 Display Frames for the COM1 Serial Interface Parameters

The configuration of the COM1 interface is shown with these display frames. The display functions are analogue to the COM0 interface display.



The parameter settings have no effect on the serial interface COM1 in case of synchronisation of System via serial interface by the **hopf** Master/Slave string. At this, the parameters are firmly adjusted to 9600baud, 8 data bit, no parity and 1 stop bit.

5.3.9 LAN Board Parameters

Further information and an explanation of the parameters can be found in the description of the LAN Board.



The LAN Board parameters are cyclically updated (approximately every 10 seconds) in Control Board 6844(RC), as these can also be changed via the WebGUI of the respective Board.

5.3.9.1 Display Frames for LAN Board 1 Parameters

The configuration of the LAN Board coded as Board 1 is displayed on this display frame.

IP Address Displays

Selection frame:

S	H	O	W	L	A	N	_	1			
I	P	-	A	D	R	.			Y	/	N

Display frame:

L	A	N	_	1		I	P	-	A	D	R	.			
>	1	9	2	.	1	6	8	.	2	0	2	.	2	1	0

Gateway Address Displays

Selection frame:

S	H	O	W	L	A	N	_	1						
G	A	T	E	W	A	Y	-	A	D	R	.	Y	/	N

Display frame:

L	A	N	_	1		G	W	-	A	D	R	.			
>	1	9	2	.	1	6	8	.	2	0	2	.	0	1	0

Network Mask Displays

Selection frame:

S	H	O	W	L	A	N	_	1			
N	E	T	M	A	S	K			Y	/	N

Display frame:

L	A	N	_	1		N	E	T	M	A	S	K			
>	2	5	5	.	2	5	5	.	2	5	5	.	0	0	0

Control Byte Displays

Selection frame:

S	H	O	W	L	A	N	_	1				
C	T	R	L	.	-	B	Y	T	E	Y	/	N

Display frame:

C	T	R	L	.	-	B	7	6	5	4	3	2	1	0
L	A	N	_	1		>	0	0	0	0	0	0	1	0

5.3.9.2 Display Frames for LAN Board 2 Parameters

Selection frame:

S	H	O	W	L	A	N	_	2			
I	P	-	A	D	R	.			Y	/	N

The configuration of the LAN Board coded as Board 2 is displayed on this display frame.

The LAN Board 2 parameters are displayed in the same way as for LAN Board 1.

5.3.9.3 Display Frames for LAN Management Board Parameters (System 6844RC only)



Only displayed on System 6844RC when the LAN Management Board / Module is activated.

This display frame shows the configuration of the LAN Management Board.

IP Address Displays

Selection frame:

S	H	O	W	L	A	N	_	M	N	G		
I	P	-	A	D	R	.		Y	/	N		

Display frame:

L	A	N	_	M	N	G		I	P	-	A	D	R	.	
>	1	9	2	.	1	6	8	.	2	0	2	.	2	1	1

Gateway Address Displays

Selection frame:

S	H	O	W	L	A	N	_	M	N	G				
G	A	T	E	W	A	Y	-	A	D	R	.	Y	/	N

Display frame:

L	A	N	_	M	N	G		G	W	-	A	D	R	.	
>	1	9	2	.	1	6	8	.	2	0	2	.	0	1	0

Network Mask Displays

Selection frame:

S	H	O	W	L	A	N	_	M	N	G		
N	E	T	M	A	S	K		Y	/	N		

Display frame:

L	A	N	_	M	N	G		N	E	T	M	A	S	K	
>	2	5	5	.	2	5	5	.	2	5	5	.	0	0	0

Control Byte Displays

Selection frame:

S	H	O	W	L	A	N	_	M	N	G		
C	T	R	L	.	-	B	Y	T	E	Y	/	N

Display frame:

C	T	R	L	.	-	B		7	6	5	4	3	2	1	0
L	A	N	_	M	N	G	>	0	0	0	0	0	0	0	0

5.3.10 Frequency Output (Option)

The frequency set for the Frequency Output Board is displayed on this display frame as also the actual adjusted values for TimeON and TimeOFF.

Frequency Display

Selection frame:

S	H	O	W	F	R	E	Q	U	E	N	C	Y
										Y	/	N

Display frame:

F	R	E	Q	U	E	N	C	Y	,	H	Z	
>	0	9	0	1	2	3	5	0		H	Z	

Frequency Output Delay Display

Selection frame:

S	H	O	W	F	R	E	Q	U	E	N	C	Y	
T	i	m	e	O	N	/	O	F	F		Y	/	N

Display frame:

T	i	m	e	O	N	/	O	F	F	,	m	i	n
>	0	0	0	/	0	0	2	<					

5.3.11 Status and Pulse Output

This display frame shows the configuration byte for the status and pulse output.

Selection frame:

S	H	O	W	P	U	L	S	E				
O	U	T	P					Y	/	N		

Display frame:

P	U	L	S	E		7	6	5	4	3	2	1	0	
B	Y	T	E			>	0	0	0	0	0	0	0	1

⇐ Reference value for the 1U housing version

5.3.12 SYSTEM-Byte

The System Status Byte is displayed with this display frame. The meaning of configuration is described in **Chapter 5.2.13 Input** SYSTEM-Byte

Selection frame:

S	H	O	W	S	Y	S	T	E	M	B	Y	T	E
										Y	/	N	

Display frame:

S	Y	S	T	E	M		7	6	5	4	3	2	1	0
B	Y	T	E				>	0	0	0	0	0	0	0

5.3.13 ADD.Outputs (Digital I/O)

This display screen shows the current status of the 4 internal digital status outputs.

Selection frame:

S	H	O	W	A	D	D	.	O	U	T	S	
										Y	/	N

Display frame:

O	U	T		8	7	6	5		4	3	2	1
				x	x	x	x		1	0	0	1

Output OUT 4 : Summary error message not available	
0	inactive ⇒ summary error message is available (at least one ERROR-Bit is active)
1	active ⇒ summary error message is not available (no ERROR-Bit is set)
Output OUT 3 : SyncOFF Timer not active	
0	inactive ⇒ SyncOFF Time is running (active or lapsed)
1	active ⇒ SyncOFF Time is not running (not active and not lapsed)
Output OUT 2 : Sync.-Status = radio	
0	inactive ⇒ Sync.-Status: invalid (-), quartz (C)
1	active ⇒ Sync.-Status: radio without regulation (r), radio (R)
Output OUT 1 : System time valid	
0	inactive ⇒ Sync.-Status = "-"
1	active ⇒ Sync.-Status = "C", "r", "R"

5.3.14 ADD.Inputs (Digital I/O)

This display screen shows the current status of the 4 internal digital signal inputs.

Selection frame:

S	H	O	W	A	D	D	.	I	N	P	U	T	S
										Y	/	N	

Display frame:

	I	N		8	7	6	5		4	3	2	1
				x	x	x	x		0	0	0	0

No fixed function is currently assigned to these bits.

5.4 S.CLOCK Menu - Control of Slave Clocks with Function Board 7406

After selecting the main menu by pressing the **ENT** key the figure **3** is entered. The following selection frame appears:

Selection frame:

S	L	A	V	E	C	L	O	C	K		
L	I	N	E	1	.	.	4	>	_		

Further information and an explanation of the parameters can be found in the description of the Function Board 7406.

5.5 INI Menu - System 6844(RC) Extended Settings/Functions

Different settings can be configured for special applications and problem solutions using the **INI** menu. These functions are pre-set to Standard ex works.

After selecting the main menu display by pressing the **ENT** key the figure **4** is entered.

Pressing the **BR** key returns the user to the standard display.

5.5.1 Display the Firmware Version of Board 6844(RC)

This function is used to display the current firmware version of Board 6844(RC).

Selection frame:

F	I	R	M	W	A	R	E	V	E	R	.
								Y	/	N	

e.g.

Display frame:

S	Y	S	T	E	M	6	8	4	4		
V	0	1	.	0	0	3	1	/	M	A	Y

5.5.2 Display the PCID (Product Config ID) of Board 6844(RC)

This function is used to display the PCID (Product Config ID) of Board 6844(RC). The PCID is displayed in 3 successive display frames.

Selection frame:

P	R	O	D	U	C	T	C	O	N	F	I	G
I	D	(P	C	I	D)	Y	/	N		

e.g.

Display frame 1:

1	:	0	1	6	8	4	4	0	1	1	1	4	6
D		1		1	0	0	8	1	9	8	2	0	A

Display frame 2:

2	:	0	2	0	0	3	1	0	9	1	1	0	0	2

Display frame 3:

3	:	0	0	0	6	0	0	0	1					

The **+** and **-** keys are used to scroll the display frames up / down.



The PCID allows **hopf** Elektronik GmbH to make decision about the respective System - from the distance - in support cases or, for example, when product extensions are desired. The PCID allows faster and more effective processing in support cases or other issues concerning the System.

5.5.4.1.3 Display and Set DCF77.SYS TimeOFF

The value for **DCF77.SYS TimeOFF** can be set between **002** and **255** minutes, and is used for time-restricted transmission of signal DCF77.SYS after synchronization of the System to Sync.-status "C".

Selection frame:

D	C	F	7	7	.	S	Y	S							
T	i	m	e	O	F	F			Y	/	N				

Display frame:

D	C	F	7	7	.	S	Y	S								
T	i	m	e	O	F	F			>	0	5	5	<	m	i	n

Default value: 55min.



When **DCF77.SYS (/ ADD) TimeOFF = 255 minutes**, the DCF77 signal (pulse / simulation) is always transmitted as soon as a valid time is available in the System.

5.5.4.2 Signal DCF77.ADD (Option)

In System 6844(RC), there is an option to enable a second DCF77 pulse.



The following menu items only appear when signal DCF77.ADD is enabled.

5.5.4.2.1 Display and Set DCF77.ADD Configuration

In this display frame, both the current settings for signal DCF77.ADD are displayed and the new values are entered.

Selection frame:

			D	C	F	7	7	.	A	D	D				
			C	O	N	F	.	B	Y	T	E		Y	/	N

Display frame:

B	Y	T	E		A	=	1	0	0	0	0	0	0	0	0	0
B	7	.	.	0		>	0	1	0	0	0	0	0	0	0	0

Configuration takes place in the same way as for signal DCF77.SYS.

5.5.4.2.2 Display and Set DCF77.ADD TimeOFF

Signal DCF77.ADD has no separate TimeOFF. If signal DCF77.ADD is enabled, DCF77.SYS and DCF77.ADD will be set to the same timer value.

Selection frame:

D	C	F	7	7	.	S	Y	S	/	A	D	D			
T	i	m	e	O	F	F			Y	/	N				

Display frame:

D	C	F	7	7	.	S	Y	S	/	A	D	D				
T	i	m	e	O	F	F			>	0	5	5	<	m	i	n

Default value: 55min.

5.5.5 IRIG-B (Digital) Output

This Chapter describes the structure and configuration of the digital IRIG-B signal that is available in the System.

5.5.5.1 IRIG Time Code, Structure and Timing Diagram

The IRIG time code format consists of a time code with 74 bits and has a repetition rate of one second. The bit frame is 10 msec. The bit rating is represented by pulse width modulation and is a multiple of one millisecond.

In the case of analogue output, the positive zero crossing of a sine wave (carrier frequency 1000 Hz) is modulated with the rising edge of the IRIG signal. The modulation depth should be between 3:1 and 6:1 for signal information of H/L level.

For synchronization at the start of the second, a neutral logical state - referred to as an identifier - is required.

Logic 0 = 2 msec H level
 Logic 1 = 5 msec H level
 Identifier = 8 msec H level

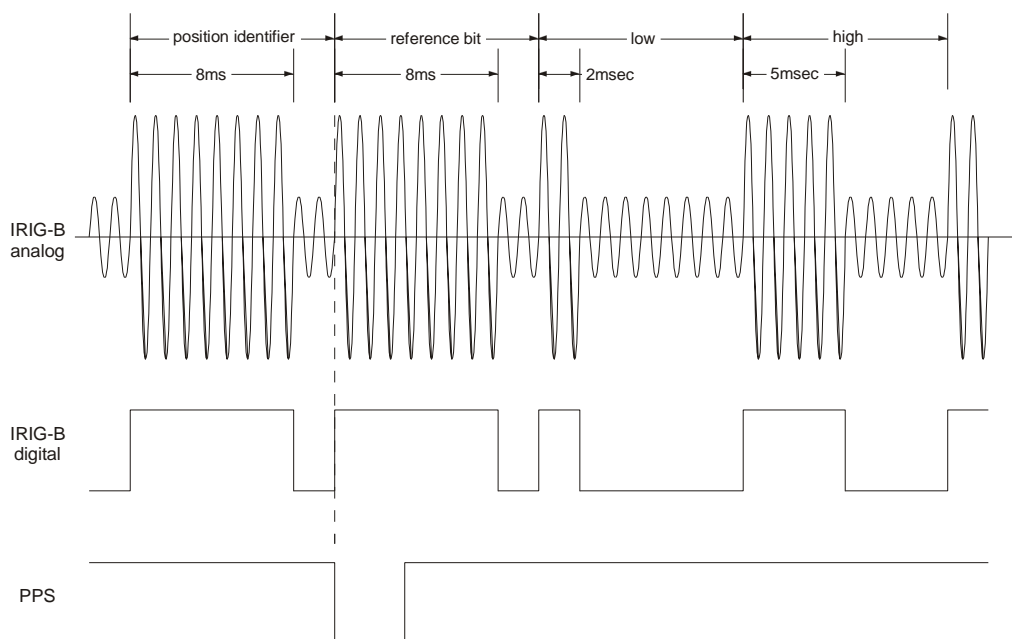

The 74 time code bits are divided into:

30 bits for the BCD value of seconds, minutes, hours, and the current day of the year

27 bits for the input of control information

17 bits for the binary value of the current day seconds

100 bit frames can be transmitted in one second. Unused bit frames are filled with a logical zero.

5.5.5.1.1 IRIG-Bxxx Format Classes in accordance with IRIG Standard 200-04

The signal output can be both digital and analogue with different data content. The variations are identified by attaching a three-digit combination of numbers. The digits indicate the following:

Digit 1	0	= digital output
	1	= analogue output via carrier signal
Digit 2	0	= no carrier signal
	1	= carrier signal 100 Hz
	2	= carrier signal 1000 Hz
Digit 3	0	= time, second of day, control information
	1	= time, control information
	2	= time
	3	= time, second of day
	4	= time, year, second of day, control information
	5	= time, year, control information
	6	= time, year
	7	= time, year, second of day

e.g. **IRIG-B123** = analogue output, carrier signal 1000 Hz
= time information data content and binary seconds of day

5.5.5.1.2 IEEE C37.188 (IEEE 1344)

This IRIG Time Code Standard is based on IRIG Standard 200-89. Fixed data such as year, time offset, etc. are assigned to the 27 bits of the control information field.

IRIG Standard 200-89 is included as a sub-section of IEEE1344.

5.5.5.1.3 AFNOR NFS 87-500

The AFNOR NFS 87-500 Code is similar to the IRIG Time Code Standard. It was established by the French Standards Association. It is based on IRIG Standard 200-89.

IRIG-B Standard 200-89 is included in part as a sub-section of AFNOR NFS 87-500.

5.5.5.2 Display and Set IRIG-B.(1) Configuration

In this display frame, both the current settings for the **IRIG-B Time Code** signal generation for signal IRIG-B.(1) are displayed and the new values are entered.

Selection frame:	IRIG - B . (1)
	CONF . BYTE Y / N
Display frame:	BYTE A = 1 0 0 0 0 0 0 0
	B 7 . . 0 > 1 0 0 0 0 0 0 1

Assignment of the **IRIG-B.(1) CONF.BYTE**

B7	B6	Time Base
0	0	Local time (time zone time with daylight saving time (DST) changeover)
0	1	Standard time (time zone time without summer time)
1	0	UTC
1	1	Not assigned (currently local time)

B5	Not assigned
x	Not assigned

B4	IRIG Time Code Signal Output
0	Not inverted
1	Inverted

B3	Not assigned
x	Not assigned

Bit 2	Bit 1	Bit 0	IRIG Time Code Format
0	0	0	IRIG-B - B002 (time)
0	0	1	IRIG-B - B006 (time, year)
0	1	0	IRIG-B - B003 (time, second of day)
0	1	1	IRIG-B - B007 (time, year, second of day)
1	0	0	IEEE1344
1	0	1	AFNOR NFS 87-500
1	1	0	Not assigned (currently IEEE1344)
1	1	1	Not assigned (currently IEEE1344)



The IRIG-B output is in accordance with **IRIG Standard 200-04**.

5.5.5.3 Display and Set IRIG-B.(1) TimeOFF

The value for **IRIG-B (1) TimeOFF** can be set between **002** and **255** minutes, and is used for the time-limited output of the IRIG time code after synchronization of the System to Quartz Status 'C'.

Selection frame:	IRIG - B . (1)
	TimeOFF Y / N
Input frame:	IRIG - B . (1)
	TimeOFF > 0 0 5 < min

The time can be increased by pressing the **+** key and reduced with the **-** key.

6 COM0 / COM1 Serial Interfaces

The System is equipped with two serial interfaces **without** handshake lines which can be set up individually. Data exchange can take place via RS232c (V.24) or RS422 (V.11) signal levels. The signals can be used, for example, to transmit time telegrams to other computers.



Using the COM0 interface as Remote-Interface (RC Systems) and COM1 interface as synchronisation interface (Sub-Master Systems) the interfaces are not available for any other functions.



The parameter settings have no effect on the serial interface COM1 in case of synchronisation of System via serial interface by the **hopf** Master/Slave string. At this, the parameters are firmly adjusted to 9600baud, 8 data bit, no parity and one stop bit.

Various data strings are available. Customer-specific data strings are available on request. The following settings can be made separately for each serial interface.



Alternatively, System pulses can also be transmitted via the serial interface hardware (see **Chapter 6.1.2.8 Mode Byte 2 / Bit7: Output Mode DATA STRING / PULSES**).

6.1 Configuration of the Serial Interfaces / Pulse Output

The parameterization and functionality of the serial interfaces respectively the selection of pulses is described below.

6.1.1 Serial Transmission Parameters

The interfaces are parameterized via the keypad. The baud rate, data bit, stop bit and parity settings are made by pressing the **ENT** key and selecting the **SET** menu.

The entry for **COM0**, **COM1** or optical interface (not supported in this equipment version) must be selected in the selection dialog. In the following only the **COM0** interface is described. The same settings are applicable to **COM1**.

- Key **ENT**
- Key **1** for **SET** menu
- Pressing Key **N** until the following menu appears

Selection frame:

SET	COM0	SERIAL
PARAMETER	Y/N	

- Key **Y**

The interfaces / parameters dialog appears on the display with the following message:

Input frame:

Bd :									
------	--	--	--	--	--	--	--	--	--

The baud rate must be entered here as a five digit numerical value. Possible inputs are:

- 19200 for 19,200 baud
- 09600 for 9,600 baud
- 04800 for 4,800 baud
- 02400 for 2,400 baud
- 01200 for 1,200 baud
- 00600 for 600 baud
- 00300 for 300 baud
- 00150 for 150 baud

After entering the final figure for the baud rate the following message appears on the display:

Input frame:

B	d	:	0	9	6	0	0		W	:	_									

The number of data bits for the transmission must be given here. Possible settings are:

- 8 for 8 data bits
- 7 for 7 data bits

After entering the figure for the number of data bits the following message appears on the display:

Input frame:

B	d	:	0	9	6	0	0		W	:	8									
P	:	_																		

The type of the parity bit for the transmission must be given here. Possible settings are:

- N for no parity bit
- E for even parity
- 0 (zero) for odd parity

After entering the parity function the following message appears on the display:

Input frame:

B	d	:	0	9	6	0	0		W	:	8										
P	:	N							S	:	1										

The number of stop bits for the transmission must be selected here:

- 1 for 1 stop bit
- 2 for 2 stop bits



No handshake lines for the serial interfaces are available in this version of the device 6844(RC).

The **ENT** key must be activated after the final entry. By doing so a plausibility check of the complete data entry is undertaken. If the data entry is valid the new settings are transferred.

6.1.2 Configuration of the Data String (Mode Byte)

The received time information can be transmitted via the interfaces in several data strings with indication of the internal synchronization status of the clock.

By this means it is possible for the user to synchronize connected computer equipment with a highly precise time. The respectively desired transmission point of time, string construction and the control characters used can be selected via the data in **Mode Bytes 1 and 2**.

The **SET** menu for the **Mode Bytes** can be reached via the following key combination:

- Key
- Key for **SET** menu
- Pressing Key until the following menu appears

Selection frame:

				S	E	T		C	O	M	0				
				M	O	D	E	B	Y	T	E	_	1		Y/N

or

Selection frame:

				S	E	T		C	O	M	0				
				M	O	D	E	B	Y	T	E	_	2		Y/N

and in addition a Mode Byte 3 is available for special strings

Selection frame:

				S	E	T		C	O	M	0				
				M	O	D	E	B	Y	T	E	_	3		Y/N



The SET menu for Mode Byte 3 is only displayed if a string which requires Mode Byte 3 for an expanded configuration was selected via Mode Byte 2.

- Key

The input mask for the **Mode Byte** appears:

Input frame:

M	o	d	B	_	1		7	6	5	4	3	2	1	0	
C	O	M	0				>	_							

The cursor now lies under bit position 7. Each bit should be understood to be a switch with which settings can be made in the operating type (mode) of the serial interface. Depending on the desired serial interface operating type the following entries must be made under the bit positions:

- 0 - for switch off or
- 1 - for switch on

The meanings of the individual bit positions (switches) are described in the following chapters.

6.1.2.1 Mode Byte 1 / Bit7 - Local Time or UTC in the Serial Output

Bit Position 7	Time Zone
off	UTC (Universal Coordinated Time)
on	Local time

6.1.2.2 Mode Byte 1 / Bit 6 - Serial Output Second Forerun

Bit Position 6	Second Forerun
off	With second forerun
on	Without second forerun

See also **Chapter 6.2 Data String Transmission Points of Time.**

6.1.2.3 Mode Byte 1 / Bit 5 - Bit 5 currently no function

Bit Position 5	
off	Not assigned
on	Not assigned

6.1.2.4 Mode Byte 1 / Bit 4 - Last Control Character at Second Change (On-Time Mark)

The last control character (see data string construction) can be transmitted exactly at the next second change with this setting.

Bit Position 4	Control Character at Second Change
off	With control character at second change
on	Without control character at second change

See also **Chapter 6.2 Data String Transmission Points of Time.**



This function is usually used in conjunction with the "with second forerun" setting.

6.1.2.5 Mode Byte 1 / Bit 3 - Reverse Control Characters CR and LF

The character sequence CR and LF can be reversed with this switch.

Bit Position 3	Control Characters CR and LF
off	LF/CR sequence as in string description
on	LF/CR sequence reversed from string description

6.1.2.6 Mode Byte 1 / Bit 2 - Delayed Transmission

The last character of the data string is transmitted directly at the second change and immediately thereafter the new data string, which is valid for the next second change, is transmitted with the setting "Control Character at Second Change". This can be interpreted as an error on some computers with a high working load. With Bit Position 2, transmission of the new data string can be delayed dependent on the baud rate.

Bit Position 2	Transmission Delay
off	With delayed transmission
on	Without delayed transmission

See also **Chapter 6.2 Data String Transmission Points of Time.**

Example:**Baud rate 9600 baud**

<u>Milliseconds</u>	<u>With delay</u>	<u>Without delay</u>
000	End character (ETX)	End character (ETX)
002	–	New data string
025	–	End new data string
930	New data string	–
955	End new data string	–
000	End character (ETX)	End character (ETX)

Baud rate 2400 baud

<u>Milliseconds</u>	<u>With delay</u>	<u>Without delay</u>
000	End character (ETX)	End character (ETX)
002	–	New data string
105	–	End new data string
810	New data string	–
913	End new data string	–
000	End character (ETX)	End character (ETX)

6.1.2.7 Mode Byte 1 / Bit1-Bit0 - Data String Transmission Point of Time

Bit 1	Bit 0	Transmission Point of Time
off	off	Transmit every second
off	on	Transmit on minute change
on	off	Transmit on hour change
on	on	Transmit on enquiry only

6.1.2.8 Mode Byte 2 / Bit7: Output Mode DATA STRING / PULSES

Bit 7	Output Mode
off	Output: Data String
on	Output: Pulses



When the pulse output is activated, all other serial interface settings are ignored.

6.1.2.9 Mode Byte 2 / Bit6-Bit0 - Data String Selection

The transmitted data string is set with this Mode Byte. In this regard, account must be taken of Mode Byte 2 setting bit 7 (see **Chapter 6.1.2.8 Mode Byte 2 / Bit7: Output Mode DATA STRING / PULSES**).



Bits B6-B4 are not currently assigned and must be set to **off**.

Bit Position				
3	2	1	0	Data String Construction
off	off	off	off	hopf Standard String (6021) respectively NTP
off	off	off	on	hopf 2000 - 4 digit year output
off	off	on	off	hopf Master/Slave-String
off	off	on	on	SINEC H1
off	on	off	off	T-String
off	on	off	on	IBM Sysplex Timer Model 1+2 and respectively TimeServ
off	on	on	off	ALOHA
off	on	on	on	SINEC H1 Extended
on	off	off	off	NMEA - GPRMC
on	off	off	on	SAT 1703 Time String
on	off	on	off	NMEA - GPZDA
on	off	on	on	GPS2000
on	on	off	off	IEC-103 (ASDU Type 6)
on	on	off	on	ABB-SPA
on	on	on	off	SPT-String
on	on	on	on	hopf Analysis String 01



The **hopf** Master/Slave-String is always transmitted if a data string is selected that is not assigned in the System

6.1.2.10 Mode Byte 2 / Bit6-Bit0: Pulse Selection

The transmitted pulse is set with this Mode Byte. In this regard, account must be taken of Mode Byte 2 setting bit 7 (see **Chapter 6.1.2.8 Mode Byte 2 / Bit7: Output Mode**).



Bits B6-B4 are not currently assigned and must be set to **off**.

Bit Position				
3	2	1	0	Pulse
off	off	off	off	IRIG-B.(1)
off	off	off	on	IRIG-B.(2) [1]
off	off	on	off	DCF77.SYS
off	off	on	on	DCF77.ADD [1]
off	on	off	off	RC-Pulse IMP1 [1]
off	on	off	on	RC-Pulse IMP2 [1]
off	on	on	off	RC-Pulse IMP3 [1]
off	on	on	on	RC-Pulse IMP4 [1]
on	off	off	off	Frequency 1 [1]
on	off	off	on	Frequency 2 [1]
on	off	on	off	SystemPPS
on	off	on	on	Sync-Source PPS / DCF77 pulse (e.g. PPS from GPS)

[1] Optional functions, dependent on the software / hardware configuration.



A **2Hz disturbing signal** is always transmitted if a pulse is selected that is not available in the System, or not assigned

6.1.2.11 Mode Byte 3 / Bit7-Bit0

The configuration of Mode Byte 3 is dependent on the preset data string. Explanations about this are given in the relevant chapter concerning the data string.

6.1.3 Serial Data String Request

Serial data string requests that are not included in this Chapter are described under Data Strings.

6.1.3.1 Serial Requests with ASCII Characters (*hopf* Standard and *hopf* 2000)

The transmission of a data string can also be triggered by the user on enquiry by means of an ASCII character. The following characters trigger the transmission of the standard string:

- ASCII "D" - for Time / Date (Local Time)
- ASCII "G" - for Time / Date (UTC Time)

The System answers within 1msec. with the corresponding data string.

Since this is often too fast for the requesting computer, it is also possible to realize a response delay in 10msec. steps on request via software. For the delayed transmission of the data string, the requesting computer transmits the lower case letters "d, g" to the clock with a two position multiplication factor.

The clock interprets the multiplication factor as a hexadecimal value.

Example:

The computer transmits **ASCII gFF** (Hex 67, 46, 46)

The clock transmits the Time / Date (UTC Time) data string after approx. 2550 milliseconds.

6.2 Data String Transmission Points of Time

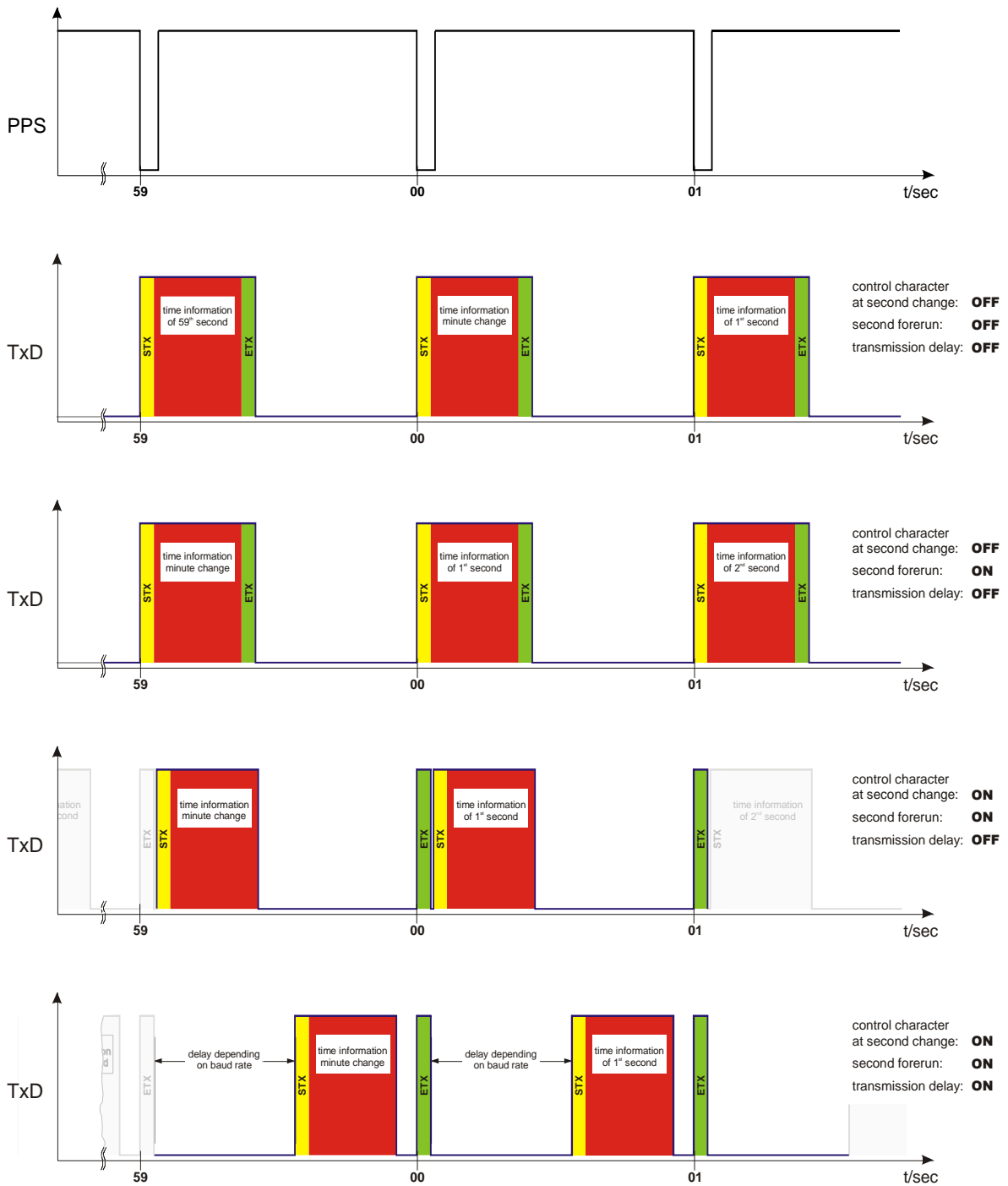

STX ⇨ Start of Text

ETX ⇨ End of Text

6.3 Data Strings

This Chapter describes the data strings supported by this System.

6.3.1 General Information about Data Output of Board 6844(RC)

When "last control character at second change" is set there is a transmission gap of up to 970msec., depending on the baud rate. This should be taken into consideration when programming the time-out on the reception side.

The output of control characters CR and LF can be reversed with **Mode Byte 1** on all data strings

(see **chapter 6.1.2.5 Mode Byte 1 / Bit 3 - Reverse Control Characters CR and LF**).



Received data on the serial interface that are not specified in the pertinent data string might disturb and interrupt the cyclic string output. The receiving synchronization interface should be set to "transmitting on request" for Sub-Master (Slave) Systems.

Possible string-specific settings are specified for all data strings. These are differentiated as follows:

Required:	Required string settings must be set by the customer after selection of a data string in the Mode Byte.
------------------	---

6.3.2 **hopf** Standard String (6021)

Below the **hopf** Standard String is described.

6.3.2.1 Specified Settings

Required:	no
------------------	-----------

6.3.2.2 Structure

Character No.	Meaning	Hex-Value
1	STX (start of text)	\$02
2	status (internal clock status)	\$30-39, \$41-46
3	day of the week (1=Monday ... 7=Sunday) for UTC time bit 3 is set to 1 in the day of the week	\$31-37
4	tens hour	\$30-32
5	unit hour	\$30-39
6	tens minute	\$30-35
7	unit minute	\$30-39
8	tens second	\$30-36
9	unit second	\$30-39
10	tens day	\$30-33
11	unit day	\$30-39
12	tens month	\$30-31
13	unit month	\$30-39
14	tens year	\$30-39
15	unit year	\$30-39
16	LF (line feed)	\$0A
17	CR (carriage return)	\$0D
18	ETX (end of text)	\$03

6.3.2.3 Status

The second and the third ASCII-character contain the status and the day of the week.
The status is decoded binary.

	b3	b2	b1	b0	Meaning
Status:	x	x	x	0	no announcement hour
	x	x	x	1	announcement (DST changeover)
	x	x	0	x	standard time
	x	x	1	x	daylight saving time (DST)
	0	0	x	x	time / date invalid
	0	1	x	x	crystal operation
	1	0	x	x	radio operation
	1	1	x	x	radio operation (high accuracy)

Day of the Week:	0	x	x	x	CEST / CET
	1	x	x	x	UTC - time
	x	0	0	1	Monday
	x	0	1	0	Tuesday
	x	0	1	1	Wednesday
	x	1	0	0	Thursday
	x	1	0	1	Friday
	x	1	1	0	Saturday
	x	1	1	1	Sunday

Status	operation mode	time	announcement SZ-WZ-SZ
0 = 0000	time invalid	winter	no announcement
1 = 0001	time invalid	winter	announcement
2 = 0010	time invalid	summer	no announcement
3 = 0011	time invalid	summer	announcement
4 = 0100	quartz	winter	no announcement
5 = 0101	quartz	winter	announcement
6 = 0110	quartz	summer	no announcement
7 = 0111	quartz	summer	announcement
8 = 1000	radio	winter	no announcement
9 = 1001	radio	winter	announcement
A = 1010	radio	summer	no announcement
B = 1011	radio	summer	announcement
C = 1100	radio	winter	no announcement
D = 1101	radio	winter	announcement
E = 1110	radio	summer	no announcement
F = 1111	radio	summer	announcement

6.3.2.4 Example

(STX)E4123456180702(LF)(CR)(ETX)

- It is Thursday 18.07.2002 - 12:34:56 o'clock.
- radio operation (high accuracy)
- daylight saving time
- no announcement of a changeover
- () - ASCII-control characters e.g. (STX)

6.3.3 Data String for NTP (Network Time Protocol)

NTP or also xNTP is a batch of programmes to synchronise different computers and operating systems with network support. It is the standard for the Internet Protokoll TCP/IP (RFC-1305). Source code and documentation are available as freeware in the internet under the following address:

<http://www.ntp.org>

6.3.3.1 Specified Settings

Required:	<p><u>parameter of transmission:</u></p> <ul style="list-style-type: none"> • baud rate 9600 • 8 data bit • parity no • 1 stop bit <p><u>parameter of transmission:</u></p> <ul style="list-style-type: none"> • hopf Standard String (6021) • UTC as time base • second in advance = on • control character (STX...ETX) enabled • with ETX as On Time Mark • Output time and date • output every second
------------------	--

6.3.3.2 Structure

NTP is according to the **hopf** Standard String (see **Chapter 6.3.2 hopf Standard String (6021)**).

6.3.3.3 Status

The Status is according to the **hopf** Standard String (see **Chapter 6.3.2 hopf Standard String (6021)**).

6.3.3.4 Example

(STX)EB123456061102(LF)(CR)(ETX)

- It is Wednesday 06.11.2002 - 12:34:56 o'clock.
- radio operation (high accuracy)
- UTC
- no announcement for ST/WT changeover (nonexistent in case of UTC)
- () - ASCII control character e.g. (STX)

6.3.4 *hopf*2000 - 4 Digit Year Output

Below the data string *hopf*2000 - 4 Digit Year Output is described.

The structure of the data string is the same as the standard string and differs only in as much as the year is transmitted with 4 digits.

6.3.4.1 Specified Settings

Required:	no
------------------	-----------

6.3.4.2 Structure

Character No.	Meaning	Hex-Value
1	STX (start of text)	\$02
2	status (internal clock status)	\$30-39, \$41-46
3	day of the week (1=Monday ... 7=Sunday) for UTC time bit 3 is set to 1 in the day of the week	\$31-37
4	tens hour	\$30-32
5	unit hour	\$30-39
6	tens minute	\$30-35
7	unit minute	\$30-39
8	tens second	\$30-36
9	unit second	\$30-39
10	tens day	\$30-33
11	unit day	\$30-39
12	tens month	\$30-31
13	unit month	\$30-39
14	thousandths year	\$31-32
15	hundreds year	\$30, \$39
16	tens year tens digit	\$30-39
17	unit year unit digit	\$30-39
18	LF (line feed)	\$0A
19	CR (carriage return)	\$0D
20	ETX (end of text)	\$03

6.3.4.3 Status

The second and the third ASCII-character contain the status and the day of the week. The status is decoded binary. Structure of these characters:

	b3	b2	b1	b0	Meaning
Status:	x	x	x	0	no announcement hour
	x	x	x	1	announcement (DST changeover)
	x	x	0	x	standard time
	x	x	1	x	daylight saving time (DST)
	0	0	x	x	time / date invalid
	0	1	x	x	crystal operation
	1	0	x	x	radio operation
	1	1	x	x	radio operation (high accuracy)
Day of the Week:	0	x	x	x	CEST / CET
	1	x	x	x	UTC - time
	x	0	0	1	Monday
	x	0	1	0	Tuesday
	x	0	1	1	Wednesday
	x	1	0	0	Thursday
	x	1	0	1	Friday
	x	1	1	0	Saturday
	x	1	1	1	Sunday

6.3.4.4 Example

(STX)E412345618072002(LF)(CR)(ETX)

- It is Thursday 18.07.2002 - 12:34:56 o'clock
- radio operation (high accuracy)
- daylight saving time
- no announcement of a changeover
- () - ASCII-control characters e.g. (STX)

6.3.5 *hopf* Master/Slave-String

The *hopf* Master/Slave-String can be used to synchronise slave systems with the time data of the master system.

The *hopf* Master/Slave-String transmits:

- the full time information (hour, minute, second)
- the date (day, month, year [2 digits])
- the difference time local to UTC (hour, minute)
- the day of the week
- status information (announcement of DST changeover, announcement of a leap second and the status of reception of the *hopf* Master/Slave-String source)

6.3.5.1 Specified Settings

Required:	<p>The following settings are required for the synchronisation of the <i>hopf</i> slave-systems:</p> <ul style="list-style-type: none"> • Normally points of time every minute, depending on system also every second • output second forerun • ETX on the second change; selectable: data string at the beginning or at the end of the 59. second. • local time • 9600 baud, 8 bit, 1 stop bit, no parity <p>This setting guarantees the best control of the time basis in the slave systems.</p>
------------------	---



Received data on the serial interface that are not specified in the pertinent data string might disturb and interrupt the cyclic string output. The receiving synchronization interface should be set to "transmitting on request" for Sub-Master (Slave) Systems.

6.3.5.2 Structure

Character No.	Meaning	Hex-Value
1	STX (start of text)	\$02
2	status	\$30-39, \$41-46
3	day of the week	\$31-37
4	tens hour	\$30-32
5	unit hour	\$30-39
6	tens minute	\$30-35
7	unit minute	\$30-39
8	tens second	\$30-36
9	unit second	\$30-39
10	tens day	\$30-33
11	unit day	\$30-39
12	tens month	\$30-31
13	unit month	\$30-39
14	tens year	\$30-39
15	unit year	\$30-39
16	difference time tens hour / operational sign	\$30-31, \$38-39
17	difference time unit hour	\$30-39
18	difference time tens minutes	\$30-35
19	difference time unit minutes	\$30-39
20	LF (line feed)	\$0A
21	CR (carriage Return)	\$0D
22	ETX (end of text)	\$03

The difference time is transmitted in hours and minutes following the year. The transmission is done in BCD. The difference time may be up to $\pm 14.00h$.

The operational sign is shown as the highest bit in the hours.

logic **1** = local time before UTC

logic **0** = local time after UTC

Example:

Data String	Tens Difference Time Nibble	Difference Time
(STX)83123456030196 <u>0</u> 300(LF)(CR)(ETX)	<u>0000</u>	- 03:00h
(STX)83123456030196 <u>1</u> 100(LF)(CR)(ETX)	<u>0001</u>	- 11:00h
(STX)83123456030196 <u>8</u> 230(LF)(CR)(ETX)	<u>1000</u>	+ 02:30h
(STX)83123456030196 <u>9</u> 100(LF)(CR)(ETX)	<u>1001</u>	+ 11:00h

6.3.5.3 Status

	b3	b2	b1	b0	Meaning
Status:	x	x	x	0	no announcement hour
	x	x	x	1	announcement (DST changeover)
	x	x	0	x	standard time
	x	x	1	x	daylight saving time (DST)
	x	0	x	x	no announcement leap second
	x	1	x	x	announcement leap second
	0	x	x	x	crystal operation
	1	x	x	x	radio operation
Day of the Week:	0	0	0	1	Monday
	0	0	1	0	Tuesday
	0	0	1	1	Wednesday
	0	1	0	0	Thursday
	0	1	0	1	Friday
	0	1	1	0	Saturday
	0	1	1	1	Sunday

Status	Operating Mode	Time	DST changeover	Leap Second
0 = 0000	quartz	standard time	no announcement	no announcement
1 = 0001	quartz	standard time	announcement	no announcement
2 = 0010	quartz	DST	no announcement	no announcement
3 = 0011	quartz	DST	announcement	no announcement
4 = 0100	quartz	standard time	no announcement	announcement
5 = 0101	quartz	standard time	announcement	announcement
6 = 0110	quartz	DST	no announcement	announcement
7 = 0111	quartz	DST	announcement	announcement
8 = 1000	radio	standard time	no announcement	no announcement
9 = 1001	radio	standard time	announcement	no announcement
A = 1010	radio	DST	no announcement	no announcement
B = 1011	radio	DST	announcement	no announcement
C = 1100	radio	standard time	no announcement	announcement
D = 1101	radio	standard time	announcement	announcement
E = 1110	radio	DST	no announcement	announcement
F = 1111	radio	DST	announcement	announcement

DST = daylight saving time

6.3.5.4 Example

(STX)841234561807028230(LF)(CR)(ETX)

- It is Thursday 18.07.2002 - 12:34:56 o'clock
- radio operation
- standard time
- no announcement of a changeover
- The difference time to UTC is +2.30 h

6.3.6 SINEC H1

Below the data string SINEC H1 is described.

String request

The data string SINEC H1 can also send by request. The time of output will be set to "send only by request" and the string will be requested with the ASCII character "?".

6.3.6.1 Specified Settings

Required:	no
------------------	-----------

6.3.6.2 Structure

Character No.	Meaning	Hex-Value
1	STX (start of text)	\$02
2	"D" ASCII D	\$44
3	":" colon	\$3A
4	tens day	\$30-33
5	unit day	\$30-39
6	"." point	\$2E
7	tens month	\$30-31
8	unit month	\$30-39
9	"." point	\$2E
10	tens year	\$30-39
11	unit year	\$30-39
12	"," semicolon	\$3B
13	"T" ASCII T	\$54
14	":" colon	\$3A
15	day of the week	\$31-37
16	"," semicolon	\$3B
17	"U" ASCII U	\$55
18	":" colon	\$3A
19	tens hour	\$30-32
20	unit hour	\$30-39
21	"." point	\$2E
22	tens minute	\$30-35
23	unit minutes	\$30-39
24	"." point	\$2E
25	tens second	\$30-36
26	unit second	\$30-39
27	"," semicolon	\$3B
28	"#" or space	\$23 / \$20
29	"*" or space	\$2A / \$20
30	"S" or space	\$53 / \$20
31	"!" or space	\$21 / \$20
32	ETX (end of text)	\$03

6.3.6.3 Status

The characters 28-31 in the data string SINEC H1 tell the synchronisation status of the clock.

The characters mean the following:

character no. 28 = "#" no radio synchronisation after reset, time invalid
 " " (space) radio synchronisation after reset, clock in crystal operation

character no. 29 = "*" time from internal crystal in the clock
 " " (space) time by radio reception

character no. 30 = "S" daylight saving time
 " " (space) standard time

character no. 31 = "!" announcement of a DST or standard time changeover
 " " (space) no announcement

6.3.6.4 Example

(STX)D:18.07.02;T:4;U:12.34.56; _ _ _ _ (ETX) (_) = Space

- It is Thursday 18.07.02 - 12:34:56 o'clock
- radio operation
- standard time
- no announcement of a changeover

6.3.7 T-String

Below the T-String is described.

The T-string can be transmitted in all modes (e.g. **forerun** or **last control characters on the second change**). The data string can be requested by "T".

6.3.7.1 Specified Settings

Required:	no
------------------	-----------

6.3.7.2 Structure

Character No.	Meaning	Hex-Value
1	"T" ASCII T	\$54
2	":" colon	\$3A
3	tens year	\$30-39
4	unit year	\$30-39
5	":" colon	\$3A
6	tens month	\$30-31
7	unit month	\$30-39
8	":" colon	\$3A
9	tens day	\$30-33
10	unit day	\$30-39
11	":" colon	\$3A
12	tens day of the week	\$30
13	unit day of the week	\$31-37
14	":" colon	\$3A
15	tens hour	\$30-32
16	unit hour	\$30-39
17	":" colon	\$3A
18	tens minute	\$30-35
19	unit minute	\$30-39
20	":" colon	\$3A
21	tens second	\$30-36
22	unit second	\$30-39
23	CR (carriage return)	\$0D
24	LF (line feed)	\$0A

6.3.7.3 Status

No status contained in the T-String.

6.3.7.4 Example

T:02:07:18:04:12:34:56(CR)(LF)

- It is Thursday 18.07.02 - 12:34:56 o'clock

6.3.8 IBM Sysplex Timer Model 1+2

This protocol is used for the synchronization of an IBM 9037 Sysplex Timer. The IBM Sysplex Timer expects the time at its input every second.

While starting the Sysplex Timer the ASCII-sign "**C**" is sent to the connected radio controlled clock. The listed protocol in the table is automatically given out every second by that.

6.3.8.1 Specified Settings

Required:	<ul style="list-style-type: none"> • 9600 baud • 8 data bit • odd parity • 1 stop bit • sending on request without forerun and without control characters
------------------	--

The setting UTC or local time is optional.



The above parameters can be changed manually after activating. But after a reset or a system reboot the parameters will be overwritten with the above parameters again.

6.3.8.2 Structure

Character No.	Meaning	Hex-Value
1	SOH (start of header)	\$02
2	hundreds current day of the year	\$30-33
3	tens current year	\$30-39
4	unit current year	\$30-39
5	":" colon	\$3A
6	tens hour	\$30-32
7	unit hour	\$30-39
8	":" colon	\$3A
9	tens minute	\$30-35
10	unit minute	\$30-39
11	":" colon	\$3A
12	tens second	\$30-35
13	unit second	\$30-39
14	Quality Identifier	\$20, 41, 42, 43, 58
15	CR (carriage return)	\$0D
16	LF (line feed)	\$0A

6.3.8.3 Status

The 14th character ("Quality Identifier") informs about the synchronisation status of the clock. Possible values and their meaning are listed below.

"?"	=	question mark	=	no radio controlled time
" "	=	space	=	radio controlled time at hand
"A"	=	Hex 41	=	crystal operation for more than 20 minutes
"B"	=	Hex 42	=	crystal operation for more than 41 minutes
"C"	=	Hex 43	=	crystal operation for more than 416 minutes
"X"	=	Hex 58	=	crystal operation for more than 4160 minutes

6.3.8.4 Example

(SOH)050:12:34:56 _ (CR) (LF) (_) = Space

- It is 12:34:56 o'clock
- radio operation
- 50th day of the year

6.3.9 Data String ALOHA

The ALOAH data string refers to the data string IBM 9037 Sysplex Timer. All settings like transmission parameters and points of transmission can be set freely.

6.3.9.1 Specified Settings

Required:	no
------------------	-----------

6.3.9.2 Structure

Character No.	Meaning	Hex-Value
1	SOH (start of header)	\$02
2	hundreds current day of the year	\$30-33
3	tens current year	\$30-39
4	unit current year	\$30-39
5	":" colon	\$3A
6	tens hour	\$30-32
7	unit hour	\$30-39
8	":" colon	\$3A
9	tens minute	\$30-35
10	unit minute	\$30-39
11	":" colon	\$3A
12	tens second	\$30-35
13	unit second	\$30-39
14	Quality Identifier	\$20, 41, 42, 43, 58
15	CR (carriage return)	\$0D
16	LF (line feed)	\$0A

6.3.9.3 Status

Character number 14 informs about the synchronisation status of the clock. Possible values and their meaning are listed below.

"?"	=	question mark	=	no radio controlled time
" "	=	space	=	radio controlled time at hand
"A"	=	Hex 41	=	crystal operation for more than 20 minutes
"B"	=	Hex 42	=	crystal operation for more than 41 minutes
"C"	=	Hex 43	=	crystal operation for more than 416 minutes
"X"	=	Hex 58	=	crystal operation for more than 4160 minutes

6.3.9.4 Example

(SOH)050:12:34:56 _ (CR) (LF) (_) = Space

- It is 12:34:56 o'clock
- radio operation
- 50th day of the year

6.3.10 SINEC H1 Extended

Below the data string SINEC H1 Extended is described.

String request

The data string SINEC H1 Extended can also send by request. The time of output will be set to "send only by request" and the string will be requested with the ASCII character "?".

6.3.10.1 Specified Settings

Required:	no
------------------	-----------

6.3.10.2 Structure

Character No.	Meaning	Hex-Value
1	STX (start of text)	\$02
2	"D" ASCII D	\$44
3	":" colon	\$3A
4	tens day	\$30-33
5	unit day	\$30-39
6	":" point	\$2E
7	tens month	\$30-31
8	unit month	\$30-39
9	":" point	\$2E
10	tens year	\$30-39
11	unit year	\$30-39
12	"," semicolon	\$3B
13	"T" ASCII T	\$54
14	":" colon	\$3A
15	day of the week	\$31-37
16	"," semicolon	\$3B
17	"U" ASCII U	\$55
18	":" colon	\$3A
19	tens hour	\$30-32
20	unit hour	\$30-39
21	":" point	\$2E
22	tens minute	\$30-35
23	unit minutes	\$30-39
24	":" point	\$2E
25	tens second	\$30-36
26	unit second	\$30-39
27	"," semicolon	\$3B
28	"#" or " " (space)	\$23 / \$20
29	"*" or " " (space)	\$2A / \$20
30	"S", "U" or " " (space)	\$53 / \$55 / \$20
31	!", "A" or " " (space)	\$21 / \$41 / \$20
32	ETX (end of text)	\$03

6.3.10.3 Status

The characters 28-31 in the data string SINEC H1 Extended tell the synchronisation status of the clock.

The characters mean the following:

character no. 28 = "#"	no radio synchronisation after reset, time invalid
" " (space)	radio synchronisation after reset, clock in crystal operation
character no. 29 = "*" "	time from internal crystal in the clock
" " (space)	time by radio reception
character no. 30 = "S"	daylight saving time
"U"	UTC (see chapter 6.1.2.1
" " (space)	Mode Byte 1 / Bit7 - Local Time or UTC in the Serial Output) standard time
character no. 31 = "!"	announcement of a DST or standard time changeover
"A"	announcement of a leap second
" " (space)	no announcement

6.3.10.4 Example

(STX)D:18.07.02;T:4;U:12.34.56; _ _ _ _ (ETX) (_) = Space

- It is Thursday 18.07.02 - 12:34:56 o'clock
- radio operation
- standard time (winter time)
- no announcement of a changeover

6.3.11 NMEA 0183 - GPRMC (V3.00)

The full NMEA format¹ 0183 GPRMC contains the position-, rate- and time data (UTC) calculated by the GPS receiver. The different information are separated in the data string by a comma. If a system information is not available (e.g. by the Sub-Master (Slave) System) only a comma is set as separator.

Data String Format by:

The below transmitted data string contains only the time information in UTC and only by GPS systems additionally the position in the following format:

GPS System

```
$GPRMC,hhmmss.ss,A,WWW.WWWW,w,LLLL.LLLL,l,,,DDMMYY,,,a*CC<CR><LF>
```

Sub-Master (Slave) Systems

```
$GPRMC,hhmmss.ss,A,,,,,,,,,DDMMYY,,,a*CC<CR><LF>
```



The information for the speed, direction and magnetic direction (compass) are not present.

All information are transmitted between the ASCII characters "\$" and "**", followed by two characters for the checksum (EXOR calculated characters between "\$" and "**"). The hexadecimal values of the upper and lower 4 bits of the checksum are transferred into ASCII characters. The binary values **A-F** are transferred to the ASCII characters **"A"- "F"** (41h - 46h).

All information are transmitted as ASCII characters with 8 bit word length, 1 stop bit and no parity.

The structure of string contains the following information:

Information	Format	Description
Time Source	"GP"	Time Source= GPS
String Identifier	"RMC"	Recommended Minimum Sentence C
Time	hhmmss.ss	Hours, Minutes, Seconds & Milliseconds
Status (Character # 18)	A	" A " = synchronous: Status of the clock is "R" or "r" " V " = not synchronous: Status of the clock "-" or "C"
Position Width (GPS systems only)	WWW.WWWW	Degree & Minute Decimal Point and Fractional Digits
Position Width (GPS systems only)	w	Hemisphere: " N "=North, " S "=South
Position Length (GPS systems only)	LLLL.LLLL	Degree & Minute Decimal Point and Fractional Digits
Position Length (GPS systems only)	l	Direction: " E "=East, " W "=West
Mode Indicator (Character # 56)	a	" A " = synchronous: Status of the clock is "R" or "r" " N " = not synchronous: Status of the clock is "-" or "C"
Checksum	CC	The checksum is calculated from the XOR function between "\$" and "**" of all transmitted ASCII characters. All information are transmitted as ASCII characters.

¹ NMEA = National Marine Electronics Association

6.3.11.1 Specified Settings

Required:	<ul style="list-style-type: none"> • baud rate = 4800 baud • word length = 8 bit • stop bit = 1 • parity = no parity • transmission point = every second • second forerun off • control character at second change off • transmission delay off • time base = UTC
------------------	--

6.3.11.2 Structure (GPS / Sub-Master)

GPS System

Character No.	Meaning	Hex-Value
1	"\$" string start	\$24
2	"G"	\$47
3	"P"	\$50
4	"R"	\$52
5	"M"	\$4D
6	"C"	\$43
7	"," comma as separation	\$2C
8	tens hour UTC-time	\$30-32
9	unit hour	\$30-39
10	tens minute	\$30-35
11	unit minute	\$30-39
12	tens second	\$30-35
13	unit second	\$30-39
14	"." point as separation	\$2E
15	tenth second	\$30-39
16	hundredth second	\$30-39
17	"," comma as separation	\$2C
18	"A" respectively "V" Status	\$41,\$56
19	"," comma as separation	\$2C
20	tens width degree	\$30-39
21	unit width degree	\$30-39
22	tens width minute	\$30-36
23	unit width minute	\$30-39
24	"." point as separation	\$2E
25	tenth width minute	\$30-39
26	hundredth width minute	\$30-39
27	thousandth width minute	\$30-39
28	ten thousandth width minute	\$30-39
29	"," comma as separation	\$2C
30	"N" respectively "S"	\$4E,\$53
31	"," comma as separation	\$2C

32	hundreds length degree	\$30-31
33	tens length degree	\$30-39
34	unit length degree	\$30-39
35	tens length minute	\$30-36
36	unit length minute	\$30-39
37	"," point as separation	\$2E
38	0.1 th length minute	\$30-39
39	0.01 th length minute	\$30-39
40	0.001 th length minute	\$30-39
41	0.0001 th length minute	\$30-39
42	"," comma as separation	\$2C
43	"E" respectively "W"	\$45,\$57
44	"," comma as separation	\$2C
45	"," comma as separation	\$2C
46	"," comma as separation	\$2C
47	tens day	\$30-33
48	unit day	\$30-39
49	tens month	\$30-31
50	unit month	\$30-39
51	tens year	\$30-39
52	unit year	\$30-39
53	"," comma as separation	\$2C
54	"," comma as separation	\$2C
55	"," comma as separation	\$2C
56	"A" resp. "N" Mode-Indicator	\$41,\$4E
57	"*" limiting of data string	\$2A
58	tens Checksum	\$30-39
59	unit Checksum	\$30-39
60	CR (carriage return)	\$0D
61	LF (line feed)	\$0A

Sub-Master (Slave) Systems

Character No.	Meaning	Hex-Value
1	"\$" string start	\$24
2	"G"	\$47
3	"P"	\$50
4	"R"	\$52
5	"M"	\$4D
6	"C"	\$43
7	"," comma as separation	\$2C
8	tens hour	\$30-32
9	unit hour	\$30-39
10	tens minute	\$30-35
11	unit minute	\$30-39
12	tens second	\$30-35
13	unit second	\$30-39
14	"." point as separation	\$2E
15	tenth second	\$30-39
16	hundredth second	\$30-39
17	"," comma as separation	\$2C
18	"A" respectively "V" Status	\$41,\$56
19	"," comma as separation	\$2C
20	"," comma as separation	\$2C
21	"," comma as separation	\$2C
22	"," comma as separation	\$2C
23	"," comma as separation	\$2C
24	"," comma as separation	\$2C
25	"," comma as separation	\$2C
26	tens day	\$30-33
27	unit day	\$30-39
28	tens month	\$30-31
29	unit month	\$30-39
30	tens year	\$30-39
31	unit year	\$30-39
32	"," comma as separation	\$2C
33	"," comma as separation	\$2C
34	"," comma as separation	\$2C
35	"A" resp. "N" Mode-Indicator	\$41,\$4E
36	"*" limiting of data string	\$2A
37	tens Checksum	\$30-39
38	unit Checksum	\$30-39
39	CR (carriage return)	\$0D
40	LF (line feed)	\$0A

6.3.11.3 Status

The characters 21-26 in the data string indicate the synchronisation status of the clock.

The characters mean the following:

Character no. 18 =	"A"	synchronous: Status of the clock is "R" or "r"
	"V "	not synchronous: Status of the clock "-" or "C"
Character no. 56 (35) =	"A"	time from internal crystal in the clock
	"N"	time by radio reception

6.3.11.4 Example

GPS System

```
$GPRMC,065517.00,A,5112.7003,N,00739.7908,E,,,210809,,,A*64<cr><lf>
```

- It is Friday 21 August 2009 - 06:55:17h (UTC).
- The clock is synchronous ("r" or "R").
- The position of the antenna is 51°12,7003' latitude north
and 7°39,7908' longitude east
- The clock is synchronous ("r" or "R").

Examples of data strings, before, during and after inserting a any leap-second:

Leap-second turn of the year 2009->2010

```
$GPRMC,235958.00,A,5112.7003,N,00739.7908,E,,,311209,,,A*5E<cr><lf>
$GPRMC,235959.00,A,5112.7003,N,00739.7908,E,,,311209,,,A*5F<cr><lf>
$GPRMC,235960.00,A,5112.7003,N,00739.7908,E,,,311209,,,A*55<cr><lf>
$GPRMC,000000.00,A,5112.7003,N,00739.7908,E,,,010110,,,A*57<cr><lf>
$GPRMC,000001.00,A,5112.7003,N,00739.7908,E,,,010110,,,A*56<cr><lf>
$GPRMC,000002.00,A,5112.7003,N,00739.7908,E,,,010110,,,A*55<cr><lf>
```

Sub-Master (Slave) Systems

```
$GPRMC,065517.000,A,,,,,,,,,210809,,,A*64<cr><lf>
```

- It is Friday 21 August 2009 - 06:55:17h (UTC).
- The clock is synchronous ("r" or "R").

Examples of data strings, before, during and after inserting a any leap-second:

Leap-second turn of the year 2009->2010

```
$GPRMC,235958.00,A,,,,,,,,,311209,,,A*5E<cr><lf>
$GPRMC,235959.00,A,,,,,,,,,311209,,,A*5F<cr><lf>
$GPRMC,235960.00,A,,,,,,,,,311209,,,A*55<cr><lf>
$GPRMC,000000.00,A,,,,,,,,,010110,,,A*57<cr><lf>
$GPRMC,000001.00,A,,,,,,,,,010110,,,A*56<cr><lf>
$GPRMC,000002.00,A,,,,,,,,,010110,,,A*55<cr><lf>
```

6.3.12 SAT 1703 Time String

All modes can be transmitted with the SAT 1703 Time String (e.g. with forerun or end character at second change).

The SAT 1703 Time String can also be sent on request. The point of transmission will be set to "transmission on request". The SAT 1703 Time String can be requested with ASCII-character "?".

6.3.12.1 Specified Settings

Required:	no
-----------	----

6.3.12.2 Structure

Character No.	Meaning	Hex-Value	
1	STX (start of text)	\$02	
2	tens day	\$30-33	
3	unit day	\$30-39	
4	."	\$2E	
5	tens month	\$30-31	
6	unit month	\$30-39	
7	."	\$2E	
8	tens year	\$30-39	
9	unit year	\$30-39	
10	"/"	\$2F	
11	unit day of the week	\$31-37	
12	"/"	\$2F	
13	tens hours	\$30-32	
14	unit hours	\$30-39	
15	":"	\$3A	
16	tens minutes	\$30-35	
17	unit minutes	\$30-39	
18	":"	\$3A	
19	tens seconds	\$30-35	
20	unit seconds	\$30-39	
21	"M" or "M" or "U"	(Standard time, Daylight saving time or UTC)	\$4D, \$4D, \$55
22	"E" or "E" or "T"		\$45, \$45, \$54
23	"Z" or "S" or "C"		\$5A, \$53, \$43
24	" " or "Z" or " "		\$20, \$5A, \$20
25	" " (\$20 ⇒ synchronous) or "*" (\$2A ⇒ not synchronous)	\$20 \$2A	
	" " (\$20 ⇒ no announcement) or "! " (\$21 ⇒ announcement of a DST or standard time changeover)	\$20 \$21	
27	CR (carriage return)	\$0D	
28	LF (line feed)	\$0A	
29	ETX	\$03	

6.3.12.3 Status

The characters 21-26 in the SAT 1703 Time String indicate the synchronisation status of the clock.

The characters mean the following:

Character no. 21-24 =	"MESZ"	Central European Summertime (Daylight Saving Time)
	"MEZ "	Central European Time (standard time / winter time)
	"UTC "	Coordinated Universal Time
Character no. 25 =	"*"	time from internal crystal in the clock
	" " (space)	time by radio reception
Character no. 26 =	"!"	announcement of a DST or standard time changeover
	" " (space)	no announcement

6.3.12.4 Example

(STX) 18.07.02/4/02:34:45UTC__ _ (CR)(LF)(ETX)

- It is Thursday 18.07.02 - 02:34:45 o'clock UTC
- The clock is synchronous

6.3.13 NMEA 0183 - GPZDA (V3.00) (GPS)

The complete NMEA format² 0183 GPRMC includes the time data (UTC) by a GPS receiver. The different information are separated by commas in the data telegram. If an information is missing only the separation comma is transmitted.

Data string format:

This transmitted telegram contains the time information in UTC and the position in the following format:

```
$GPZDA,hhmmss,DD,MM,YYYY,hhh,mm*CC<CR><LF>
```



The information on speed, the track and magnetic directions (compass) are not available.

All information are transmitted between the ASCII characters "\$" and "*", followed by two characters for the checksum (EXOR calculated characters between "\$" and "*"). The hexadecimal values of the upper and lower 4 bits of the checksum are transferred into ASCII characters. The binary values **A-F** are transferred to the ASCII characters "A"- "F" (41h - 46h).

All information are transmitted as ASCII characters with 8 bit word length, 1 stop bit and no parity.

The structure of string contains the following information:

Information	Format	Description
Time Base	GP	Time Base=GPS
String Identifier	ZDA	String for Time & Date
Time	hhmmss	Hours, Minutes, Seconds
Date	DD,MM,YYYY	Day, Month, Year (4 digits)
Local Time	hhh,mm	Hours with pre-sign, Minutes
Checksumme	CC	The checksum is calculated from the XOR function between "\$" and "*" of all transmitted ASCII characters. All information are transmitted as ASCII characters.

² NMEA = National Marine Electronics Association

6.3.13.1 Specified Settings

Required:	<ul style="list-style-type: none"> • baud rate = 4800 baud • word length = 8 bit • stop bit = 1 • parity = no parity • transmission point = every second • second forerun off • control character at second change off • transmission delay off • time base = UTC
------------------	--

6.3.13.2 Structure

Character No.	Meaning	Hex-Value
1	"\$" string start	\$24
2	"G" identifier time basis GPS	\$47
3	"P"	\$50
4	"Z" identifier time information data	\$52
5	"D"	\$4D
6	"A"	\$43
7	"," comma as separation	\$2C
8	tens hour (UTC)	\$30-32
9	unit hour (UTC)	\$30-39
10	tens minute (UTC)	\$30-35
11	unit minute (UTC)	\$30-39
12	tens second (UTC)	\$30-35
13	unit second (UTC)	\$30-39
14	"," comma as separation	\$2C
15	tens day (UTC)	\$30-33
16	unit day (UTC)	\$30-39
17	"," comma as separation	\$2C
18	tens month (UTC)	\$30-31
19	unit month (UTC)	\$30-39
20	"," comma as separation	\$2C
21	thousands digit year (UTC)	\$31-32
22	hundreds digit year (UTC)	\$30, \$39
23	tens year (UTC)	\$30-39
24	unit year (UTC)	\$30-39
25	"," comma as separation	\$2C
26	"+" or "-" sign local time zone	\$2B, \$2D
27	tens hour (local time zone diff.)	\$30-32
28	unit hour (local time zone diff.)	\$30-39
29	"," comma as separation	\$2C
30	tens minute (local time zone diff.)	\$30-35
31	unit minute (local time zone diff.)	\$30-39
32	"*" string limitation	\$2A
33	tens checksum	\$30-39, \$41-46
34	unit checksum	\$30-39, \$41-46
35	CR (carriage return)	\$0D
36	LF (line feed)	\$0A

6.3.13.3 Status

This data string contains no status information.

6.3.13.4 Example

```
$GPZDA,123456,26,09,2003,-02,00*6C(CR)(LF)
```

- Output UTC time
- It is Friday 26 September 2003 - 12:34:56h (UTC)
- Difference Time -2 hours (2 hours east)
=> *Local Time 14:34:56h*

Examples of data strings before, during and after the changeover:

Changeover summer time->winter time (in October 2009/ MEZ time zone)

```
$GPZDA,005957,25,10,2009,-02,00*64<cr><lf>
$GPZDA,005958,25,10,2009,-02,00*6B<cr><lf>
$GPZDA,005959,25,10,2009,-02,00*6A<cr><lf>
$GPZDA,010000,25,10,2009,-01,00*68<cr><lf>
$GPZDA,010001,25,10,2009,-01,00*69<cr><lf>
$GPZDA,010002,25,10,2009,-01,00*6A<cr><lf>
```

Examples of data strings before, during and after inserting of any leap-second:

Leap-second turn of the year 2009->2010 (MEZ time zone)

```
$GPZDA,235958,31,12,2009,-01,00*6E<cr><lf>
$GPZDA,235959,31,12,2009,-01,00*6F<cr><lf>
$GPZDA,235960,31,12,2009,-01,00*65<cr><lf>
$GPZDA,000000,01,01,2010,-01,00*67<cr><lf>
$GPZDA,000001,01,01,2010,-01,00*66<cr><lf>
$GPZDA,000002,01,01,2010,-01,00*65<cr><lf>
```

Examples of data strings before, during and after the changeover:

Changeover summer time->winter time (in March 2009/ MEZ time zone)

```
$GPZDA,005957,29,03,2009,-01,00*69<cr><lf>
$GPZDA,005958,29,03,2009,-01,00*66<cr><lf>
$GPZDA,005959,29,03,2009,-01,00*67<cr><lf>
$GPZDA,010000,29,03,2009,-02,00*65<cr><lf>
$GPZDA,010001,29,03,2009,-02,00*64<cr><lf>
$GPZDA,010002,29,03,2009,-02,00*67<cr><lf>
```

6.3.14 GPS2000 Data String

Below the data string GPS2000 is described.

6.3.14.1 Specified Settings

Required:	<ul style="list-style-type: none"> • 9600 Baud, 8 bit, 1 stop bit, even parity • Output every second • Control characters: standard (direct, without delay) • Time basis and second forerun as required • Transmission time: every second • CR ⇒ LF
------------------	---

6.3.14.2 Structure

Character No.	Meaning	Hex-Value
1	Soh (start of header)	\$01
2	hundreds day in the year	\$30-33
3	tens day in the year	\$30-39
4	unit day in the year	\$30-39
5	: (colon)	\$3A
6	tens hours	\$30-39
7	unit hours	\$30-36
8	: (colon)	\$3A
9	tens minutes	\$30-33
10	unit minutes	\$30-39
11	: (colon)	\$3A
12	tens seconds	\$30-39
13	unit seconds	\$30-39
14	time accuracy	\$3F, \$23, \$2A, \$2E, \$20
15	CR (carriage return)	\$0D
16	LF (line feed)	\$0A

6.3.14.3 Status

Time Accuracy in the GPS2000 Data String

Hex-value	ASCII-value	Description	Meaning, details of accuracy
\$3F	?	question mark	Error greater than 1 msec
\$23	#	double dagger	Error greater than 100 µsec
\$2A	*	star	Error greater than 10 µsec
\$2E	.	point	Error greater than 1 µsec
\$20		space	Error greater than 1 µsec

6.3.14.4 Example

(SOH)042:12:34:56*(CR)(LF)

- It is day of the year 42,
- 12:34:56 o'clock,
- The system time inaccuracy is greater than 10 µsec.

6.3.15 IEC-103 (ASDU Type 6)

Reference: IEC60870-5-103



This data string requires the configuration of **Mode Byte 3** (see **Chapter 6.3.15.4 Initialization String for IEC-103 (ASDU Type 6)**).

6.3.15.1 Specified Settings

Required:	<ul style="list-style-type: none">• baud rate: 9600 Baud• 8 data bit• 1 stop bit• parity: even• transmission point = every minute• control character at second change: off• second forerun: off• transmission delay: off• Mode byte 3 (address): 0 to 255 (\$00-FF)
------------------	---

6.3.15.2 Structure

Character No.	Meaning	Hex-Value
1	Start flag	\$68
2	Length of Information	\$0F
3	Repeated length of Information	\$0F
4	Start flag	\$68
5	Control field	\$44
6	Station address	\$FF
7	Frame Type identification	\$06
8	Variable structure identifier	\$81
9	Cause of transmission	\$08
10	Common address of ASDU	\$FF
11	Function type	\$FF
12	Information number	\$00
13	Milliseconds (Low octet)	\$0000-EA5F
14	Milliseconds (High octet)	
15	Minutes (0..59) + MSB = Invalid Flag	\$00-3B, \$80-BB
16	Hours (0..23) + MSB = SU Summer time Flag	\$00-17, \$80-97
17	Days (1..31)	\$01-1B
18	Months (1..12)	\$01-0C
19	Years (00..99)	\$00-63
20	Checksum (sum of fields 5 to 19 mod 256)	\$00-FF
21	End flag	\$16

MSB of minute: 1 = clock is not synchronous (time invalid or quartz)
 0 = clock is synchronous

MSB of hour: 1 = daylight saving time
 0 = standard time

The seconds are displayed in the value of the milliseconds.

Thus the millisecond value runs from 0 .. 59999 decimal or from 0000 .. EA5F hexadecimal.
 (If output is set to the minute change this value is always 0)

The checksum is the sum of byte 5 to 19 Modulo 256.

6.3.15.3 Example

The length of the data string is fixed to 21 characters. All characters including special characters are allowed. Only binaurally values are transmitted.

The transmitted values are given out hexadecimal:

<68><0f><0f><68><44><ff><06><81><08><ff><ff><00><00><00><05><08><11><87><09><fe><16>

- Time is 08:05:00.000 at 17th July 2009
- daylight saving time
- The clock is synchronous.

6.3.15.4 Initialization String for IEC-103 (ASDU Type 6)

This initialization string is sent with ascending IEC address every second unless the minute change. The IEC address is continuously repeated from 1 to a selectable value of maximal 255 (\$00-FF). Setting up the IEC address is done in **Mode Byte 3**.



Disable the initialization string:

- Setting the IEC address to "0"
- or
- Transmission point: every minute

Mode Byte 3 for Initialization String IEC-103

B7	B6	B5	B4	B3	B2	B1	B0	DEC	HEX	Note
0	0	0	0	0	0	0	0	0	\$00	Initialization deactivated
0	0	0	0	0	0	0	1	1	\$01	
0	0	0	0	0	0	1	0	2	\$02	
0	0	0	0	0	0	1	1	3	\$03	
:	:	:	:	:	:	:	:	:		
:	:	:	:	:	:	:	:	:		
0	0	0	0	1	1	1	1	15	\$0F	
0	0	0	1	0	0	0	0	16	\$10	
0	0	0	1	0	0	0	1	17	\$11	
:	:	:	:	:	:	:	:	:		
:	:	:	:	:	:	:	:	:		
1	1	1	1	1	1	0	0	252	\$FC	
1	1	1	1	1	1	0	1	253	\$FD	
1	1	1	1	1	1	1	0	254	\$FE	
1	1	1	1	1	1	1	1	255	\$FF	Maximum Value

Structure IEC-103

Character no.	Meaning	Hex Value
1	Start flag	10
2	Control field	47
3	IEC-Address	00-FF
4	Checksum (sum of fields 2 & 3 mod 256)	00-FF
5	End flag	16

Example

The length of data string consists of 5 characters. Just binary values are sent.

The hexadecimal values of the transmitted characters are stated:

<10><47><01><48><<16> (String initializes unit with the address 01)

<10><47><02><49><<16>

:

<10><47><0F><56><<16>

<10><47><10><57><<16>

:

<10><47><FE><45><<16>

<10><47><FF><46><<16> (String with maximal valid address)

6.3.16 ABB-SPA Seconds-Clock

The ABB-SPA data string consists of two different data strings: The Time/Date String and the Second Data String. The Time/Date String fades over the seconds data string when the output time is the same.

In case of the setting "without checksum" the ASCII characters for XX are transmitted instead of the checksum. The putout milliseconds state the (calculated) transmission time of the last character of the string.



This data string requires the configuration of **Mode Byte 3**.

6.3.16.1 Specified Settings

Settings Mode Byte 3 for data string ABB SPA

B7	free
x	currently not assigned
B6	free
x	currently not assigned

B5	separator between day and hour in time/date string)
0	space (\$20)
1	dot (\$2E)

B4	checksum
0	without checksum (appropriate position filled with "XX" (\$58 \$58))
1	with checksum

B3	B2	output point of time time/date string
0	0	6 a.m. and 6 p.m.
0	1	every hour
1	0	every 30 minutes
1	1	every minute

B1	B0	output point of time second string
0	0	every second
0	1	every 10 seconds
1	0	every 30 seconds
1	1	every minute

6.3.16.2 Structure

6.3.16.2.1 Date and Time String

Character No.	Meaning	Hex-Value
1	">" ASCII character >	\$3E
2	"9" ASCII character 9	\$39
3	"0" ASCII character 0	\$30
4	"0" ASCII character 0	\$30
5	"W" ASCII character W	\$57
6	"D" ASCII character D	\$54
7	":" colon	\$3A
8	tens year	\$30-39
9	unit year	\$30-39
10	"-" minus	\$2D
11	tens month	\$30-31
12	unit month	\$30-39
13	"-" minus	\$2D
14	tens day	\$30-33
15	unit day	\$30-39
16	"." dot	\$2E
17	tens hour	\$30-32
18	unit hour	\$30-39
19	"." dot	\$2E
20	tens minute	\$30-35
21	unit minute	\$30-39
22	":" semicolon	\$3B
23	tens second	\$30-36
24	unit second	\$30-39
25	"." dot	\$2E
26	1/10 second	\$30-39
27	1/100 second	\$30-39
28	1/1000 second	\$30-39
29	":" colon	\$3A
30	checksum (high nibble)	\$30-3F, \$58
31	checksum (low nibble)	\$30-3F, \$58
32	CR (carriage return)	\$0D

6.3.16.2.2 Second String

Character No.	Meaning	Hex-Value
1	">" ASCII-character >	\$3E
2	"9" ASCII-character 9	\$39
3	"0" ASCII-character 0	\$30
4	"0" ASCII-character 0	\$30
5	"W" ASCII-character W	\$57
6	"T" ASCII-character T	\$54
7	":" colon	\$3A
8	tens second	\$30-36
9	unit second	\$30-39
10	"." dot	\$2E
11	1/10 second	\$30-39
12	1/100 second	\$30-39
13	1/1000 second	\$30-39
14	":" colon	\$3A
15	checksum (high nibble)	\$30-3F, \$58
16	checksum (low nibble)	\$30-3F, \$58
17	CR (carriage return)	\$0D

6.3.16.3 Status

No status contained in data string ABB-SPA.

6.3.16.4 Examples

6.3.16.4.1 Date and Time String

Output with dot between day and second is set.

>900WD:04-12-07.14.27;00.035:37(CR)

- Date: 07.12.2004
- Time: 14:27:00 o'clock, 35 milliseconds
- checksum: 37

6.3.16.4.2 Second String

>900WT:02.019:10(CR)

- 2 seconds, 19 milliseconds

6.3.17 SPT String

Below the data string SPT-string is described.

The SPT-string is a data string which is transmitted every minute. The time of the transmission is selected so that the middle of the first stop bit of the synchronisation signal falls exactly on the 2nd second of every minute.



The specified characteristics are met only with the required string specific settings.

6.3.17.1 Specified Settings

Required:	<ul style="list-style-type: none"> • baud rate: 1200 baud • 8 data bits • 2 stop bits • Parity: even • transmission point = every minute • control character at second change off • second forerun on • transmission delay on
------------------	---

6.3.17.2 Structure

Only binary values are transmitted

Character No.	Meaning	Hex-Value
1	Header	\$FF
2	Header	\$01
3	Status	\$08-1F
4	Begin	\$02
5	Day of the week (1=Monday ... 7=Sunday)	\$01-07
6	Day	\$01-31
7	Month	\$01-12
8	Year	\$00-99
9	Hour	\$00-23
10	Minute	\$00-59
11	Second	\$02
12	End	\$03
13	Synchronisation character	\$16

6.3.17.3 Status

The bits have the following meaning in the transmitted status:

B0	Leap Second
0	no leap second
1	leap second inserted

B1	Reception time
0	reception not disturbed for more than 8h
1	reception disturbed for more than 8h

B2	Reception
0	reception
1	reception disturbed

B4	B3	Time
0	0	UTC
0	1	standard time
1	0	daylight saving time
1	1	invalid

B7 - B5	Free
0	---
1	---

6.3.17.4 Example

FF 01 08 02 04 13 12 12 10 09 02 03 16

- It is Thursday 13.12.2012 - 10:09:02h
- no announcement of a leap second
- reception disturbed for more than 8h
- radio operation is warranted
- standard time

6.3.18 *hopf* Analysis String 01

The *hopf* analysis string 01 should only be used and enabled in case of a problem and after contacting the *hopf* support.

6.3.18.1 Specified Settings

Required:	<ul style="list-style-type: none"> • Time base: Local time without second advance • Control character: direct, without transmission delay
Blocked:	<ul style="list-style-type: none"> • Baud rate smaller than 9600 baud • Time base: UTC • Time with second advance • The output of the last character (LF) is made at the second change • Sequence LF / CR • Activation of the transmission delay



A baud rate smaller than 9600 baud is automatically corrected to 9600 baud by the system. No failure message is indicated.

6.3.18.2 Example

```
(STX)
6844011462;
0202;00;0C07;23/081;13/081;20/081;04/075;02/075;10/069;17/051;00/000;
N051127000;E007397913;+00441;20;0C20050A0307DB;D0133206100311;8100;
0002;0000.0001;91EB;00
*6F(CR)(LF)
```

7 6844RC - Functionality

This Chapter describes the additional functions of System 6844RC compared to standard System 6844.



Subsequent activation of the RC functionality is **not** possible in the field.

System 6844RC is designed for use in conjunction with management systems.

The System can be configured via serial interface and monitored in a network environment by using a LAN Management Board / Module 6844MNG (SNMP/SYSLOG/e-mail notification) and configured via the **hopf** Management Console (**hmc**).

In the 6844RC version, four additional high-precision, programmable internal RC-Pulses are available, which can be configured exclusively via the **hopf** Management Console (**hmc**).

By default the serial connection is made via interface COM0. Optionally, a separate remote interface can also be integrated into the System so that both interfaces COM0 and COM1 are exclusively available for customer applications.

Additional Configuration Channels

In addition to the keyboard, System 6844RC offers other options to configure the System:

- **hopf** Management Console (**hmc**) via serial interface via COM0
- **hopf** Management Console (**hmc**) over the network via LAN Management Board / Module 6844MNG (option)
- Over the network via WebGUI of the LAN Management Board / Module (option)



Also for the access to these access channels a password protection is possible.

Additional Menu Items on the LCD-Display

The following additional menu items are available on System 6844RC:

- Activation of the LAN Management Board / Module in System 6844RC
- Set network parameter (SET) and show the LAN Management Board / Module (SHOW)

Additional Hardware

The following additional hardware is available in System 6844RC:

- Four internal high-precision, programmable RC-Pulses (IMP1-IMP4)
- LAN Management Board / Module
- Prepared slot for a LAN Management Board (option) - (not for 1U)
- Prepared slot for a LAN Management Board with a separate remote RS232 interface for connection to a PC (option) - (not for 1U)

7.1 RC-Pulses IMP 1-4 and RC-Output 1-4

System 6844RC provides four additional RC-Pulses and RC-outputs. These pulses are only configurable via Remote-Software (**hmc**)

The RC-Pulses consist of two elements:

1. The logical signal definition (IMP 1-4)
2. The internal signal outputs in TTL level (RC-output 1-4) on the VG ledge of the control board 6844RC

For use of pulses the following procedure needs to be considered:

1. Assignment of the functional characteristics for the RC-Pulses IMP1-4 (see **hmc** picture 1)

For the RC-Pulses IMP 1-4 the below signals are available:

- Operation
- Status of time
- Cyclic pulses
- Daily pulses
- Individual pulse
- Single / variable pulse (day of the week)

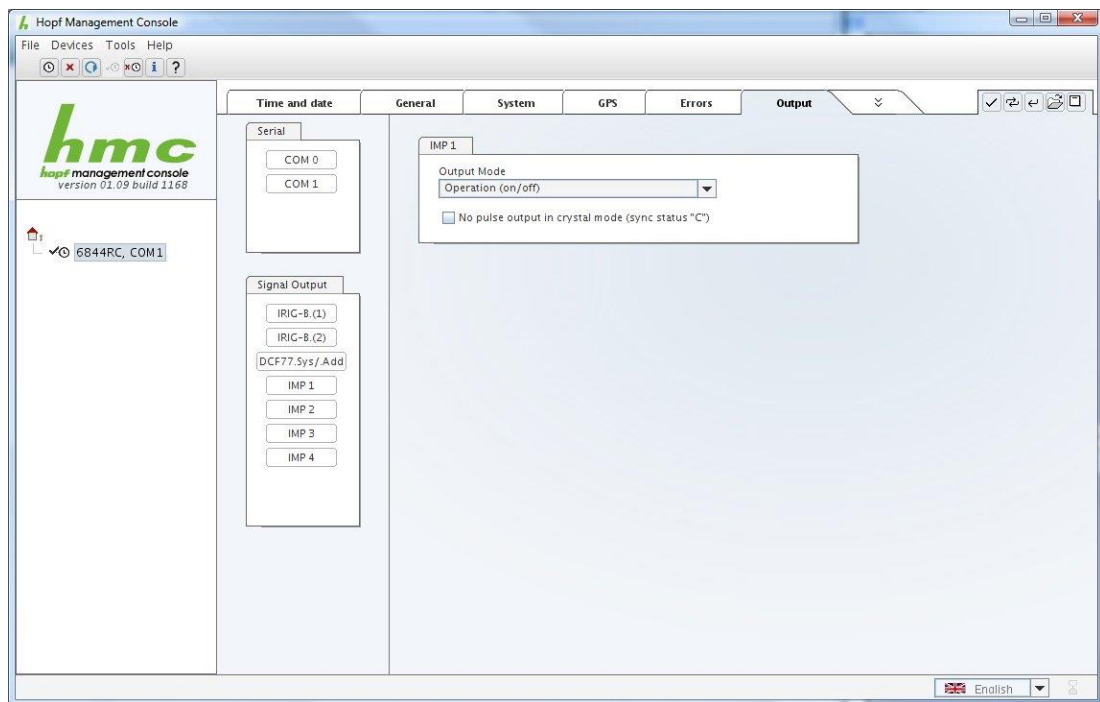

Picture: **hmc** Picture 1

2. Assignment of the pulses to the appropriate RC-outputs 1-4 (see **hmc** picture 2)



By default the RC-outputs are only provided as TTL signals at the internal VG ledge of the control board 6844RC.

The standard version of this unit does not provide any external connections for these outputs.

Should these outputs be needed, the implementation or its upgrading prior to shipment has to be processed by **hopf**. A later upgrade cannot be done by the customer.



Any number of RC-Pulses IMP1-4 can be assigned to the RC-outputs, but also other available signals (such as IRIG-B (1) etc) of the System.

For the RC-outputs the below signals are available:

- IRIG-B.(1)
- IRIG-B.(2) (optional)
- DCF77.Sys
- DCF77.Add (optional)
- RC-Pulse IMP1
- RC-Pulse IMP2
- RC-Pulse IMP3
- RC-Pulse IMP4
- Frequency 1 (optional)
- Frequency 2 (optional)
- System-PPS
- Sync-Source-PPS

For each RC-output (1-4) the signal output is separately invertible.

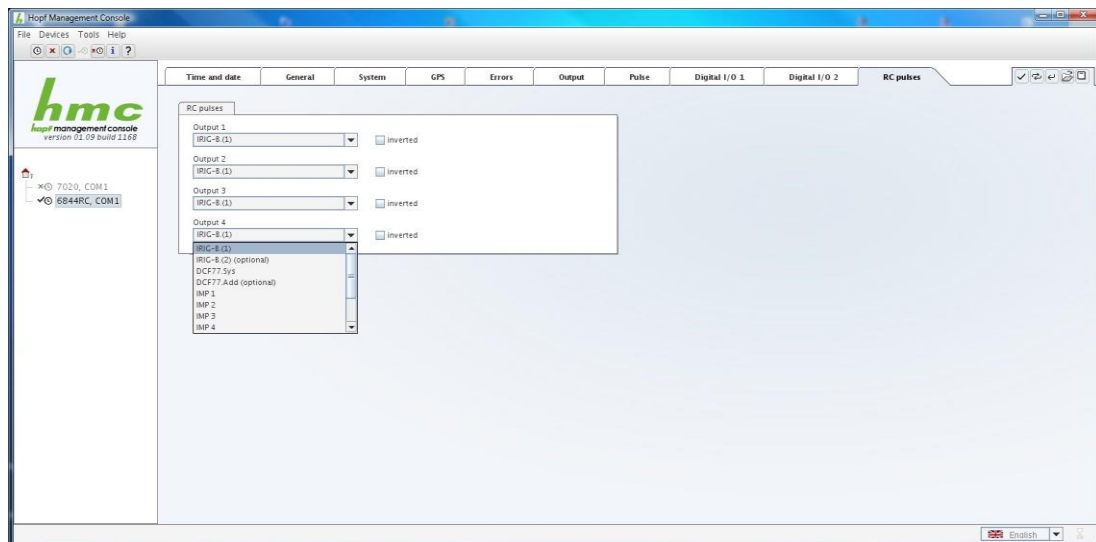

Picture: **hmc** Picture 2

7.1.1 RC-Pulses IMP 1-4 - Operating

In this setting the internal operating status is emitted at IMP 1-4.

The signal output can be inverted.

Imp 1-4	Operating
active	System 6844RC is ready
inactive	System 6844RC is not ready

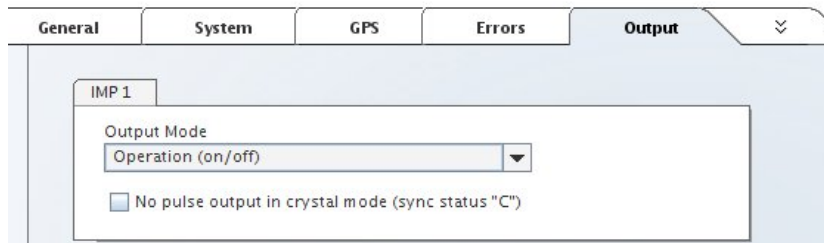

7.1.2 RC-Pulses IMP 1-4 - Time Status

In this setting the internal synchronisation status is emitted at IMP 1-4.

The signal output can be inverted.

Imp 1-4	Sync.-Status
active	radio synchronous (R, r)
inactive	not radio synchronous (C, -)

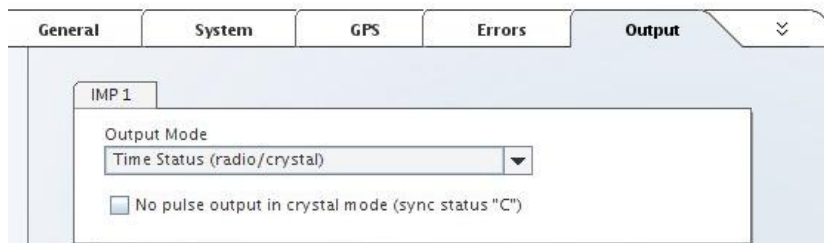

7.1.3 RC-Pulses IMP 1-4 - Cyclical Pulse

In this mode cyclical pulses with adjustable pulse width are generated at IMP 1-4. Following pulse intervals are possible::

every 1, 2, 3, 4, 6, 8, 12, 24 hours

every 1, 2, 3, 4, 5, 6, 10, 12, 15, 20, 30 minutes

every 1, 2, 3, 4, 5, 6, 10, 12, 15, 20, 30 seconds

The pulse length can be selected in the range **1 - 65,500 msec**. The pulse duration should not exceed the cycle time, otherwise the output is switched through permanently.

The signal output can be inverted.

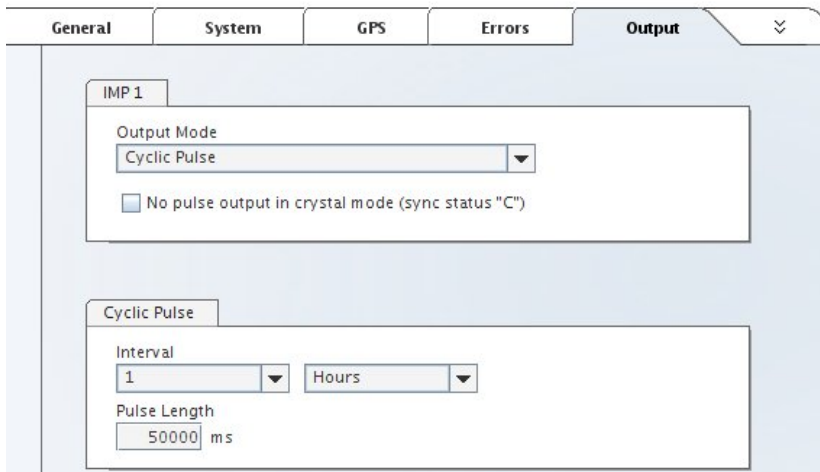

The screenshot shows the 'Output' configuration page for IMP 1. The 'Output Mode' is set to 'Cyclic Pulse'. There is an unchecked checkbox for 'No pulse output in crystal mode (sync status "C")'. The 'Cyclic Pulse' section shows an 'Interval' of '1' with a unit dropdown set to 'Hours', and a 'Pulse Length' of '50000' ms.

7.1.4 RC-Pulses IMP 1-4 - Daily Pulse

This mode generates one single pulse per day at a defined point in time at the output.

The output time of the pulse is entered in hour, minute and second.

The pulse length can be selected in the range **1 - 65,500 msec**.

The signal output can be inverted.

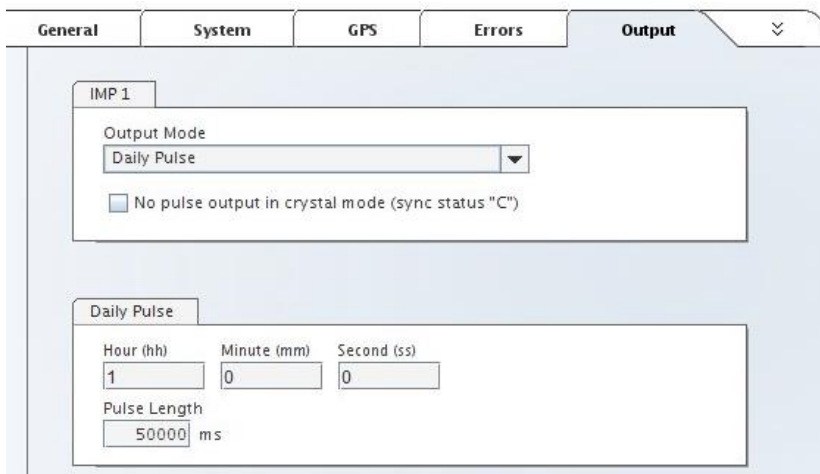

The screenshot shows the 'Output' configuration page for IMP 1. The 'Output Mode' is set to 'Daily Pulse'. There is an unchecked checkbox for 'No pulse output in crystal mode (sync status "C")'. The 'Daily Pulse' section shows three input fields for 'Hour (hh)', 'Minute (mm)', and 'Second (ss)', with values '1', '0', and '0' respectively. The 'Pulse Length' is set to '50000' ms.

7.1.5 RC-Pulses IMP 1-4 - Single Pulse

This mode generates a single pulse per time and date or cyclic pulses at a variable, adjustable date per time and date.

This is the appropriate input field for setting the different values for hour, minute and second of the pulse duration and weekday, month and year of the pulse date by entering or selecting a plausible value.

A configuration of the pulse duration and the pulse date by plausible values results in an accurate output to the second at the appropriate time or rather date with the adjusted pulse length.

Individual values to disable the pulse width / pulse rate for the activation of variable pulses according to the desired pulse output have to be deactivated. These values to calculate the pulse time points are ignored.

This allows the configuration of one pulse output within a certain time and date range.

The pulse lengths can be adjusted in the range of **1 - 65,500 msec**.

The signal output can be inverted.

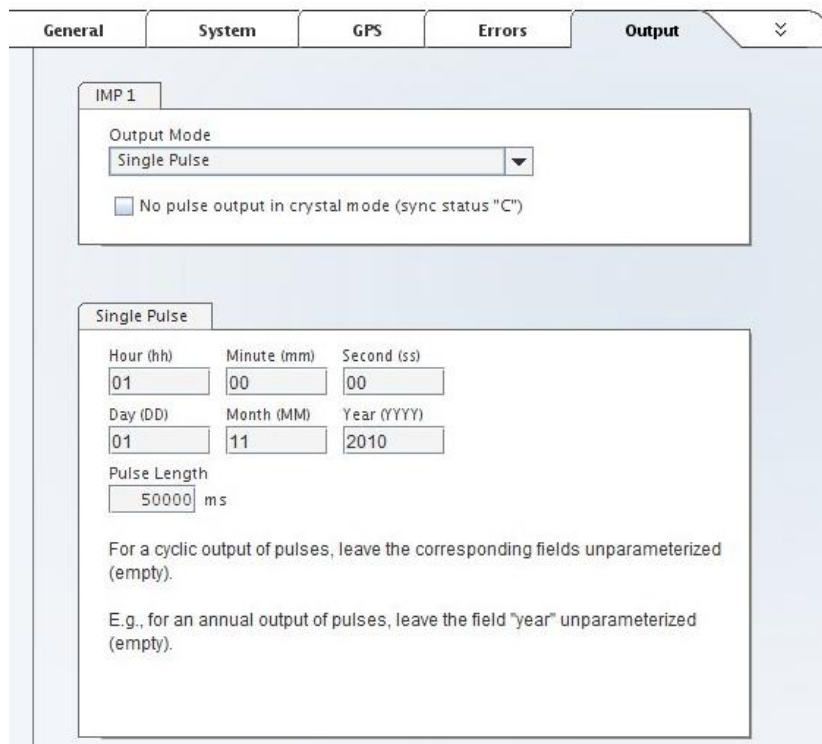

General System GPS Errors **Output**

IMP 1

Output Mode
Single Pulse

No pulse output in crystal mode (sync status "C")

Single Pulse

Hour (hh) Minute (mm) Second (ss)
01 00 00

Day (DD) Month (MM) Year (YYYY)
01 11 2010

Pulse Length
50000 ms

For a cyclic output of pulses, leave the corresponding fields unparameterized (empty).

E.g., for an annual output of pulses, leave the field "year" unparameterized (empty).

Examples: *Single / variable pulse per time/date*

hour	minute	second	day	month	year	pulse length (msec)	Pulse output
00	00	01	01	--	--	50	1. day of the month at 00:00:01 ⇒ pulse length approx. 50msec
05	58	--	--	02	--	1010	every day in February (2. month) at 05:58 ⇒ pulse length approx. 1 minute ⁽¹⁾
12	--	--	--	--	(20)10	10	every day in year 2010 from 12:00 to 13:00 ⇒ pulse every second approx. 10msec
09	--	00	05	--	--	100	Every 5th day of the month at 09:00 in the zero second ⇒ pulse length approx. 100msec

⁽¹⁾ Due to a pulse duration longer than 1000msec (1sec) there is an overlap of the pulse output.

7.1.6 RC-Pulse IMP 1-4 - One Time / Variable Pulse per Weekday

This mode generates a single pulse per time and weekday or cyclic pulses at a variable, adjustable date per time and day of the week.

This is the appropriate input field for setting the different values for hour, minute and second of the pulse duration and weekday by entering or selecting a plausible value.

A configuration of the pulse duration by plausible values results in an accurate output to the second at the appropriate time with the adjusted pulse length.

Individual values to disable the pulse width for the activation of variable pulses according to the desired pulse output have to be deactivated. These values to calculate the pulse time points are ignored.

This allows the configuration of one pulse output within a certain time and weekday range.

The pulse lengths can be adjusted in the range of **1 - 65,500 msec**.

The signal output can be inverted.

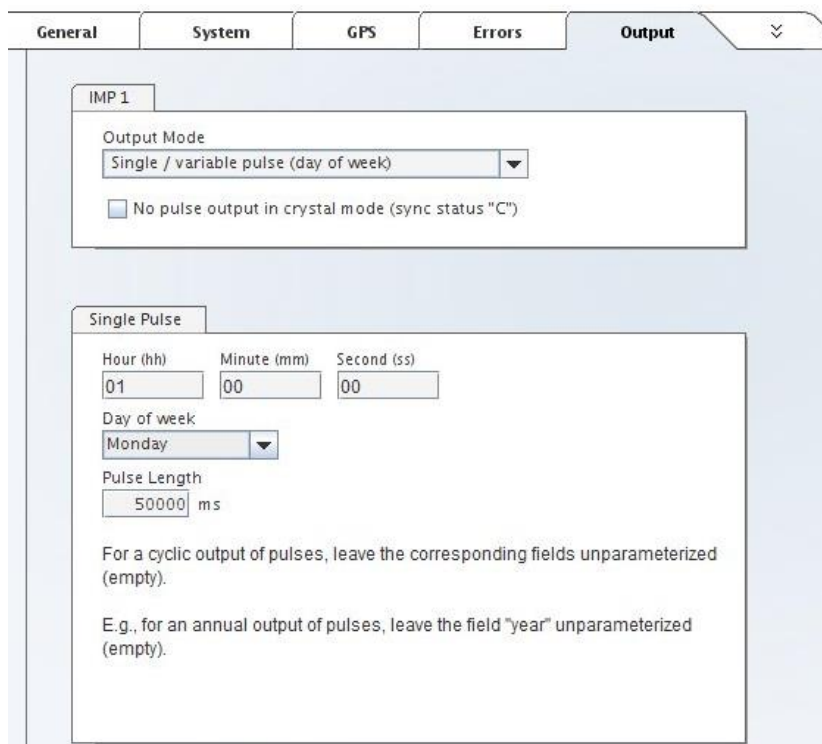

Examples: *Single pulse per weekday*

hour	minute	second	day of the week	pulse length (msec)	Pulse Output
00	00	01	Monday	50	Monday at 00:00:01 ⇒ pulse length approx. 50msec
05	58	--	Wednesday	1010	Wednesday at 05:58 ⇒ pulse length approx. 1 Minute ⁽¹⁾
09	--	--	Friday	1010	Friday at 09:00 ⇒ pulse length approx. 1 hour

- (1) Due to a pulse duration longer than 1000msec (1sec) there is an overlap of the pulse output (e.g. minute pulse)

7.2 LAN Management Board 6844MNG for 3U / Table / Wall Systems

The LAN Management Board is installed as a Function Board with a defined slot in the System-Bus of Control Board 6844RC.



The LAN Management Board subsequently can only be installed in a slot in the System prepared for this purpose (6844MNG/prepared slot).



7.3 LAN Management Module 6844MNG for 1U System

The LAN Management Module is connected to Control Board 6844RC as an integrated component of the System. An later build-in or replacement by the customer is not possible.



Subsequent installation of the LAN Management Module is **not** possible in the field.



The DCF77 antenna simulation (77.5kHz) via BNC connector, female is not applicable with implemented LAN Management Module.

8 Function Boards

These Function Boards are Euro-boards that were designed for integration in 19" Systems. All boards are connected to the System via a VG ledge (DIN41612). The boards receive their power supply and the required data or signals via these VG ledges.

The front panels of the Boards are designed as standard for 3U/19" Systems or they can be used with an adapted panel on the 1U Slim Line System.

Basically this Function Board is available in two types:

- **Function Boards for System-Bus**

These Boards can only operate on a System-Bus. However, account must be taken of board-specific restrictions.

- **Function Boards**

These Boards can operate with or without a System-Bus.

There are some points that must be considered when dealing with Function Boards:

Electrical Properties



The System and Function Boards do **not** support **hot plug** capability.

If it is necessary to exchange a board the System **must** be switched off first. Otherwise the System or Function Board could be damaged.

Power Supply

All Function Boards are powered by the operating voltage via the internal System-Bus or via system internal connections.

Mechanics

Function Boards with suitable front panels are required for installation in 1U-Systems and 3U-Systems.

Configuration

In principle there are two board types:

- Boards which are configured via DIP switches and jumpers only (the board must be configured prior to installation)
- Boards which are configured via the System 6844(RC) menu (and DIP switches or jumpers), (the base configuration of the board must be set prior to installation; the other settings are then carried out via the System 6844(RC) menu).

Factory Pre-wired Slots

In addition, some Function Boards require system-internal wiring in order to achieve the desired functionality. Where boards are to be delivered with this wiring integrated into the System the wiring is carried out in the factory.



The details of slots which are wired at the time of delivery can be found in the System drawing / specifications.

8.1 Function Boards for System-Bus

These Boards have their own onboard microcontroller and can only be used in conjunction with a System-Bus and Control Board. These Boards communicate with the Control Board over the internal System-Bus. The Control Board simultaneously monitors the Function Boards for errors. Due to the onboard microcontroller, these Boards have high performance resources that allow them to compute time-critical operations in real-time and transmit the time information highly accurately.

8.2 Function Boards

These are mostly simple output boards without their own "intelligence". Usually they receive the information to be transmitted from any desired signal source. These Boards do not necessarily need a System-Bus. However, most of these Boards can pick up the information available on the System-Bus (PPS pulse, DCF77 pulse (1 Hz)) and transmit this in a hardware format specific to the Board.

8.3 Function Boards Summary

In principle all the Function Boards presented here can be retrofitted by the customer, provided that suitable slots are available in the System. However, for certain functionalities some boards require system-internal wiring.

The following summary describes the Function Boards that are currently available and the customer retrofit information:

Function Boards for System-Bus (max. 2 Boards per System possible)	
• 7272/7273	LAN Board for NTP/SINEC H1 LAN BUS - Suitable for retrofit
• 7265	IRIG-B Output Board - Suitable for retrofit
• 7266	IRIG-B Output Board - Suitable for retrofit
• 7406	Slave Clock Board - limited suitability for retrofit (external line voltage feed required)
• 7530	Frequency Output Board - Suitable for retrofit (max. 1 Board per System)
• 7112	Optical Coupler Board for Pulse Output - Suitable for retrofit
• 7121	Relay Board for Pulse Output - Suitable for retrofit



To expand 6844(RC) Systems with **Function Boards for System-Bus**, a slot with Bus-Bridge Boards must be available for each Board.

Function Boards	
• 7318	DCF77 Antenna Distributor - Suitable for retrofit
• 7248	FO Converter F-ST - limited suitability for retrofit (for PPS and DCF77 pulse output only (1Hz))
• 7170	Optical Coupler Board - limited suitability for retrofit (for PPS and DCF77 pulse output only (1Hz))
• 6841H1	Converter Board to TTL, on enquiry
• 6841H2	Converter Board to FO-plastic on enquiry



To expand with **Function Boards**, a slot with Bus-Bridge Board or suitably prepared slot must be available for each Board.



The list of available Function Boards is continuously being increased. If you require a function that is not covered by the Function Boards listed please ask us!

8.4 Exchanging a Function Board

To exchange a Function Board for an identical board model whilst retaining all previous functions requires the following steps:

- Switch the equipment off
- Remove all connections to the Function Board to be exchanged
- Unscrew the Function Board and pull it out of the System
- Transfer all DIP and jumper settings from the old Function Board to the new board
- Insert the new Function Board into the System and tighten the screws
- Remake all connections
- Switch the equipment back on
- Set Function Board to the desired configuration via the System 6844(RC) menu if necessary



Software settings must **always** be set after replacing a function board by using the menu in order that the new function board takes over the parameters. Otherwise the parameters of the old board will be displayed but the new board doesn't take over the new one.

8.5 Installation of an Additional Function Board

In principle every Function Board can be installed at any desired point on the System 6844(RC).

Exceptions:

- Slave Line Board 7406 with any internal line voltage wiring.
If the System is not prepared for the Board 7406 in the factory then the required line voltage must be made available for the Board 7406 externally.
- Function Boards with any system-internal wiring.



The details of slots which are wired at the time of delivery can be found in the System drawing / specifications.



To expand 6844(RC) Systems with **Function Boards for System-Bus**, a slot with Bus-Bridge Boards must be available for each Board.



To expand with **Function Boards**, a slot with Bus-Bridge Board or suitably prepared slot must be available for each Board.

A slot with a Bus-Bridge Board must be available.

- Switch the equipment off.
- Unscrew the Bus-Bridge Board (or blind panel) and pull it out of the System.
- Set all DIP and jumper settings for the desired functions on the Function Board.
- Insert the new Function Board into the System and tighten the screws.
- Make all connections to the Function Board.
- Switch the equipment back on.
- Configure the Function Board via the System 6844(RC) menu as necessary.

8.6 Removing Function Boards

The following steps are required in order to remove a Function Board from the System:

- Switch the equipment off.
- Isolate all connections to the Function Board to be removed.
- Unscrew the Function Board and pull it out of the System.
- Insert the Bus-Bridge Board (or blind panel) into the System and tighten the screws.
- Switch the equipment back on.



A removed **Function Board with System-Bus must** be replaced by a Bus-Bridge Board in order to guarantee the operation of the System.

9 System Indicators / Fault Analysis / Troubleshooting

The System 6844(RC) provides a variety of indicators for presenting the System status and for problem analysis. This status information can also be used for monitoring the clock system by means of a supervisory management system.

The System 6844(RC) monitors itself and the installed Function Boards for System-Bus for faults. These may be, for example, reception failures or Function Board errors.

Faults that arise are displayed or transmitted via various elements.

9.1 Status and Fault Indicators

The System status und faults arising can be identified with the aid of the following elements:

9.1.1 Status LEDs

The 1U System has Status LEDs on both the front and rear sides (see **Chapter 1.2.3.4 Status LEDs**).

9.1.1.1 "Power" LED (1U Systems only)

The "Power" LED lights up as soon as the System is provided with power and switched on. This LED goes out if the operating voltage fails, the System is switched off or the power supply unit is faulty.

9.1.1.2 "Sync. Status" LEDs (1U Systems only)

The "Sync." LED lights up as soon as the System attains "Sync" status (r, R on the display). A change from ON (green) to OFF (red) signals the loss of synchronization. The action of the LEDs can be influenced by the "SyncOFF Timer" setting (see **Chapter 5.3.7 SyncOFF Timer - Delayed Change of Sync. Status**).

9.1.1.3 LED Power Supply Unit (not for 1U)

The standard power supply unit has an LED that lights up as soon as power is available to the power supply unit (except 1U).

9.1.2 LCD-Display

A variety of status information can be read and fault analysis carried out with the aid of the LCD-Display.

9.1.2.1 System Status on the Display

The synchronization status can be read directly on the display (see **Chapter 4.3.2 Standard Display with Valid Time**).

9.1.2.2 Number of Satellites (GPS only)

An analysis of reception can be carried out with the display of satellite values. It can be seen whether the GPS receiver is receiving satellites and, if so, their reception values (see **Chapter 5.3.3 Satellite Values (GPS only)**).

9.1.2.3 Position Display (GPS only)

Depending on the position entered manually by the user, it can be identified from the position display whether the GPS receiver calculated the position correctly and was / is therefore synchronous.

The last two digits of the item on manual entry are always 00. After synchronization of the clock system, 00 should no longer be displayed on at least one of the two lines; rather, the complete position as computed by the GPS receiver should be displayed.

9.1.2.4 SyncOFF Timer

The SyncOFF timer display shows whether the timer is running (the System outwardly displays status "r" but is no longer synchronized by the synchronization source).

It is also possible to read whether the timer has expired or was not yet activated.

9.1.2.5 Display of ERROR-Byte

Internal System errors or other problems can be identified during a faulty synchronization by means of the Error Byte (see **Chapter 5.3.1 ERROR-Byte**).



If at least one bit in the ERROR byte is active, an "E" is displayed on the bottom right of the display and the backlight flashes while the standard display is in the 1Hz pulse.

9.1.2.6 Settings of the SYSTEM-Byte

The correct settings for below functions can be checked by the display of the SYSTEM-Byte:

- Synchronisation mode
- GPS-Module-Update (no synchronization / no output via COM0)
- Simulation system status "synchronous - R"

In case of faulty system behaviour the SYSTEM-Byte should always be checked for correct parameterization.

9.1.3 Error Relays (1U Systems only - Optional for 3U / Table-Top / Wall)

There is a SUB-D connector with two relay outputs for the status output on the rear side of the System (see **Chapter 3.2.7 Error Relays Connection**).

9.1.3.1 "Power" Relay

The "Power" error relay is activated as soon as the System is supplied with the operating voltage. This relay drops out if

- the operating voltage fails,
- the System is switched off or
- the power supply unit is faulty.

9.1.3.2 "Sync" Relay

The "Sync" error relay is activated as soon as the System reaches "Sync" status (r, R on the display). A fall-off signals the loss of synchronization. The action of the relay can be influenced by the "SyncOFF Timer" setting (see **Chapter 5.3.7 SyncOFF Timer - Delayed Change of Sync. Status**).

9.1.4 Send LED



Only Boards for the System-Bus have Send LEDs (see **Chapter 8 Function Boards**)

Function Boards without a Send LED

Function Boards without a Send LED are supplied with the appropriate time information such as DCF77 pulse and PPS directly from the Control Board. The output of serial strings is also possible for this board type (additional system-internal wiring is required).

Function Boards with a Send LED

Function Boards with a Send LED have their own processor. They are provided with information via the System-Bus. These boards can prepare this time information and output it in the respective board-specific form.

9.1.5 Auto-Reset Logic (System-Bus)

The System has circular auto-reset logic. This means that each board inserted into the System-Bus (System-Bus boards only) is integrated into a reset circuit. In the event that:

- a board is removed from the System
- a board is defective
- a Function Board is in an undefined condition (program malfunction)

then this is recognized by the Control Board 6844(RC) and the System triggers a system-wide hardware-reset.

Bus-Bridge Boards installed in the factory are integrated into the auto-reset circuit and can be replaced by suitable Function Boards without system-internal modifications.

Auto-Reset Logic Operating Principle

There is a watch-dog module on the Control Board 6844(RC). An output signal transmitted from the Control Board to the System-Bus must be fed back to this module; otherwise a cyclical hardware-reset is triggered on the System-Bus.

This signal is forwarded from one Function Board to the next Function Board on the System-Bus. The signal is fed back to the Control Board from the last board via a bus termination.

In the event that a fault (e.g. program malfunction) arises on a board or the auto-reset circuit is broken (board was removed from the System), then the signal is no longer forwarded by this board and the Control Board triggers a system-wide hardware-reset via the System-Bus. After this all boards perform a defined program restart.

All boards with their own processor are actively integrated into the System's auto-reset logic. On boards without a processor the circulating signal is bridged and by this means the pulse is forwarded directly to the next board.

9.1.6 Serial Output of Data Telegrams

Many serial data telegrams contain status information that also contains the synchronization status of the System.

The status of the clock system can be ascertained in a connected System by means of this status (see **Chapter 6.3 Data Strings**).



Systems 6844 without remote interface enables the recording of these data telegrams (e.g. via "hyper terminal") a long-term analysis of the reception status.

9.1.7 RC-Functionality (6844RC Systems only)

With RC functionality, further options are available for error analysis and monitoring.

Additional Channels for Status Information

- **hmc** Management Console via serial interface via COM0
The different System statuses can be displayed and reception records performed here.
- **hmc** Management Console over the network via LAN Management Board/Module 6844MNG (option)
The different System statuses can be displayed and reception records performed here.
- Over the network via WebGUI of the LAN Management Board/Module (option)
The different System statuses can be displayed here.

9.2 Error Patterns

This Chapter describes various error patterns which enable the customer to make a preliminary problem analysis. In addition they provide an indication about how to describe the error when contacting **hopf**Support.



Basically, for an initial error analysis in each problem case, if possible, the ERROR byte should be checked.



If an active ERROR byte is present, the backlight on the LCD display FLASHES in the 1Hz pulse.

9.2.1 Complete Failure

Description

- The "Power" / power supply LED is off
- "Power" error relay has tripped (1U Systems only)
- Display not active

Cause / Problem Solution

- Equipment is switched off
- Power supply failure
- Power supply unit defective

9.2.2 "Power" / Power Supply LED "ON" - No Display and No Output

Description

- The "Power" / power supply LED lit
- Display not active
- The complete System is not functioning

Cause / Problem Solution

- The Control Board is faulty
- The voltage provided by the power supply unit is too low
 - ⇒ The external power supply is too low
 - ⇒ The power supply unit is set incorrectly / faulty

9.2.3 Power LED "ON" - No Display but Valid Signal Output

Description

- The "Power" / power supply LED lit
- Display not active or shows only dark bars
- Send LEDs of all function boards for System-Bus light up cyclically
- Data Strings are available on the serial interfaces

Cause / Problem Solution

- The display is faulty
- The connection cable between the Control Board and the display is not plugged in correctly or is faulty

9.2.4 Power LED "ON" - Cyclical Flickering of the Displays

Description

- The "Power" / power supply LED lit
- The System start frame appears on the display for a short time and then resets permanently
- Function Boards start up for a short period

Cause

- System running in auto-reset

Problem Solution

- There is a board missing in one of the function board slots for the System-Bus
- A function board for the System-Bus that is integrated into the System is faulty

9.2.5 No GPS Reception / No Synchronization

Description

- System Status "C" is on the display
- The red Sync.-Status OFF LED lights (1U Systems only)
- "Sync" error relay has tripped (1U Systems only)
- Quartz status is transmitted in the serial strings

Cause / Problem Solution

- System was not initialized correctly / completely
- Check for errors in the Error Byte (see **Chapter 5.3.1 ERROR-Byte**)
- Check settings of SYSTEM-Byte for GPS module update
- Verification of the System byte referring to correct selection of the Sync.-Source (Sync.-Mode)

The following describes various effects and their possible causes on a non-synchronizing system:

Case 1 (GPS):

Effect: After the first installation, no satellite appears on the display after several hours and **00** is displayed under **V**.

Possible errors:

- The antenna cable is too long
- An incorrect cable type was used for the length of the antenna equipment
- The antenna cable is faulty
- The antenna cable is not connected
- The antenna is faulty
- The lightning protector is faulty
- The antenna cable is connected to the wrong BNC socket (e.g. "DCF-SIM" socket instead of "Antenna")

Case 2 (GPS):

Effect: There are 7 satellites in the visibility range (**V=07**) but a maximum of 2 appear on the display frame. However, the value of these satellites is 70 or above.

Possible error:

- The visibility range of the antenna to the sky is limited

Case 3 (GPS):

Effect: The equipment was working perfectly but has not been receiving for several days. 7 satellites appear in the visibility range (**V=07**). However no satellite is displayed.

Possible errors:

- The cable has been damaged
- There was excess voltage on the antenna equipment and the indirect lightning protector is faulty
- Antenna faulty
- The GPS receiver of Control Board 6844(RC) is faulty
- A building change has had an effect on the antenna equipment (e.g. shading of the antenna caused by subsequent building installation, or the laying of cables with a high electrical alternating field in the immediate vicinity of the GPS antenna cable)
- Electronic equipment with an interference effect on the GPS signal has been put into operation in the vicinity of the GPS antenna equipment / GPS receiver (e.g. transmitter for pagers)

Case 4 (Sub-Master):

Effect: The display does not become synchronous (Status "R")

Possible errors:

- SYSTEM-Byte set to wrong Sync.-Source
- Defective wiring of the Sync.-Signal from the Master System
- Disturbed Sync.-Signal

Further information on the subject of the GPS antenna equipment can be consulted in the manual "Antenna Equipment GPS".

9.2.6 No DCF77 Antenna Simulation (77.5kHz) / DCF77 Pulse (1Hz)

Description

- A System that is connected to the DCF77 Antenna Simulation or DCF77 pulse does not synchronize.

Cause / Problem Solution

- The System is not synchronous and the timer for the DCF77 Antenna Simulation has lapsed.

9.2.7 No or Incorrect Serial Output

Description

- The connected Systems do not receive a serial string
- The connected Systems receive serial strings with a time that differs from the System

Cause / Problem Solution

- The serial interfaces are not configured correctly (e.g. only transmit on enquiry, UTC output, etc.).
- The connection to the serial interfaces is not correct (e.g. TxD and RxD cables transposed).

9.2.8 Incorrect Time Output

A wrong configuration can cause errors on the output of the local time as well as of the UTC time.



Only the local time can be entered by means of the keypad.

Local Time Description

- Transmitted **local time** is different from the actual local time

Cause / Problem Solution

- UTC/local time offset set incorrectly or not set
- DST changeover points of time set incorrectly or not set
- Time was set manually, System running in quartz mode
- Time has drifted because the System has been running in quartz mode for a long period
- Local time to UTC time offset differs from the time offset configured in the System 6844(RC) ⇒ Fault on Control Board 6844(RC)

UTC Time Description

- **UTC time** transmitted differs from the actual UTC time

Cause / Problem Solution

- Time has drifted because the System has been running in quartz mode for a long period
- Time was set manually, System running in quartz mode
Cause of incorrect UTC time on manual setting: incorrect local time entered (the local time must always be entered when setting)
or System incorrectly configured (time offset, DST changeover)

9.2.9 No Daylight Saving Time (DST) Changeover

Description

- "D" for "daylight saving time" (summer time) does not appear on the display
- The bit "daylight saving time" is not set in the status of the data string.

Cause / Problem Solution

- Changeover points of time not set or set incorrectly
- Output/display was configured for UTC and not for local time

9.2.10 Output and Function Errors of individual Function Boards

The respective board description should be consulted for error analysis of an individual Function Board.

9.3 Support from the *hopf* Company

Should the System demonstrate error descriptions other than those listed in **Chapter 9.2 Error Patterns**, please contact Support at *hopf* Elektronik GmbH with an exact description of the fault and the following information:

- With PCID (Product Config ID) or if not possible with the Serial number of the System
- Occurrence of the error during commissioning or operation
- Values of ERROR-Byte
- Value of SYSTEM-Byte
- Exact error description
- Setting Sync.-Mode
- In the case of GPS reception/synchronization problems ⇒ description of the antenna equipment used:
 - Components used (antenna, indirect lightning protector, etc.)
 - Cable type used
 - Total length of the antenna equipment
 - Sequence of components and cable lengths between the components
 - Antenna installation position (e.g. signal shading by building) and

Please write to the following E-mail address with the above information:

support@hopf.com



Providing a detailed description of the error and the information listed above avoids the need for additional clarification and leads to faster processing by our Support team.

10 Maintenance / Care

The System 6844(RC) is generally maintenance-free. The following points should be noted if it is necessary to clean the System 6844(RC):

10.1 General Guidelines for Cleaning

The following **must not** be used to clean the System 6844(RC):

- Fluids
- Cleaning agents containing solvents
- Cleaning agents containing acids
- Abrasive media

The use of such cleaning agents or media could damage the System 6844(RC)



Do not use a wet cloth to clean the System 6844(RC).
There is the danger of an electric shock.

To clean the System 6844(RC) use a cloth that is:

- Antistatic
- Soft
- Non-fabric
- Damp

10.2 Cleaning the Housing



Make sure that connections or cables are not loosened whilst cleaning the housing of an active system. There is a risk that the system could become damaged and lose functionality.

10.3 Cleaning the Display and Keypad

Minimum pressure should be exerted when cleaning the display and keypad. Excessive pressure may cause mechanical damage.



When cleaning the active System 6844(RC) make sure that System functions are not altered by accidentally pressing a key.

11 Technical Data

11.1 Specific Technical Data for 3U / Table-Top / Wall

Technical Data - System 6844(RC) 3U / Table-Top / Wall		
Housing construction:	Sheet steel / aluminium, closed 3U and Table-Top with ventilation openings for convection on top and bottom	
Housing measurement:	Dimensions are housing specifically / see Chapter 1.2.2.1 19 Inch Rack 3U/42HP and 3U/84HP, 1.2.4.1 ½ 19 Inch Table Top Housing 3U/42HP and 1.2.5.1 ½ 19 Inch Wall Housing 3U/42HP	
Housing protection class:	IP20	
Protection class:	I, with PE connection. Additional earth screw for cables up to 16mm ²	
Cooling:	Convection	
Weight:	Dependent on housing	
AC Power Supply (with Standard Power Supply)		
Nominal input voltage:	115 / 230V AC / 47-63Hz Connection via input connector compliant with IEC/EN 60320-1/C14 incl. EMI line filter	
Current consumption (at nominal values):	approx. 0.7A (115V AC) / 0.4A (230V AC)	
Mains failure bridging at nominal load:	> 20msec.	
Insulation voltage (EN60950) Input / Output:	3000V _{eff}	
Output Data (intern only)		
Internal nominal output voltage:	5V DC	
Nominal output current I _N 0°C .. +55°C:	6A (U _{OUT} = 5V DC)	
Efficiency:	> 70%	
Function display (Power LED):	LED green	
DC Power Supply 24V or 48V (Option)		
Nominal input voltage:	24V DC or 48V DC	110/220V DC
Input voltage range:	18-36V DC or 36-72V DC	100-250V DC
Current consumption (at nominal values):	2.5A or 1.3A	approx. 0,8 / 0.4A
Mains failure bridging at nominal load:	> 3msec.	> 20msec.
Insulation voltage (EN60950) Input / Output:	2.000V _{eff}	3000V _{eff}
Output Data (intern only)		
Internal nominal output voltage:	5V DC	5V DC
Nominal output current I _N 0°C .. +55°C	6A (U _{OUT} = 5V DC)	6A (U _{OUT} = 5V DC)
Efficiency:	> 70%	> 70%
Function display (Power LED)	LED green	LED green

11.2 Specific Technical Data for 1U

Technical Data - System 6844(RC) 1U	
Housing construction:	Sheet steel / aluminium, closed
Housing measurement:	see Chapter 1.2.3.1 19 Inch Rack 1U/84HP
Housing protection class:	IP20
Protection class:	I, with PE connection. Additional earth screw for cables up to 16mm ²
Cooling:	Active cooling by fans, temperature-controlled. Air inlets left / right
Weight:	approx. 3kg

AC Power Supply (with wide input range)	
Nominal input voltage:	100-240V AC / 47-63Hz Connection via input connector compliant with IEC/EN 60320-1/C14 with EMI line filter and switch
Input voltage range:	85-264V AC
Frequency:	47-63Hz
Current consumption (at nominal values):	ca. 0.37A (120V AC) / 0.23A (230V AC)
Starting current:	typ. 15A (I _o = 100%) 120V AC typ. 30A (I _o = 100%) 230V AC
Mains failure bridging at nominal load:	> 20msec. (> 100V AC)
Turn-on time after application of mains voltage:	< 500msec.
Transient overvoltage protection:	Overvoltage category II (EN 60664-1)
Input fuse - internal:	2A (equipment protection)
Recommended pre-fuse:	Line protection switch 6A, 10A characteristic B (EN 60898)
PE leakage current:	< 0.75mA (60Hz, compliant with EN 60950)
Insulation voltage input / PE:	2000V AC, 1 minute, residual current = 10mA, 500V DC, 50MΩ at least (at room temperature)
Output Data (internal only)	
Internal nominal output voltage:	5V DC
Nominal output current I _N 0°C .. +55°C:	6A (U _{OUT} = 5V DC)
Efficiency:	> 74% (at 230V AC and nominal values)
Function display (Power LED):	LED green

DC Power Supply (Option)			
Nominal input voltage:	24V DC	48V DC	110/220V DC
Input voltage range:	18-36V DC	36-76V DC	110-250V DC
Current consumption (at nominal values):	1.36A	0.68A	0.40A
Turn-on time after application of mains voltage:	< 200msec.	< 200msec.	< 500msec.
Input fuse - internal (equipment protection):	4A fast-acting	2A fast-acting	2A
Insulation voltage input / output:	1.500V DC 1 minute, 500V DC 50MΩ at least (20°C ±15°C)	1.500V DC 1 minute, 500V DC 50MΩ at least (20°C ±15°C)	2000V AC, 1 Minute, residual current = 10mA, 500V DC, 50MΩ at least (at room temp.)

Output Data (internal only)			
Internal nominal output voltage:	5V DC	5V DC	5V DC
Nominal output current I _N 0°C ... +55°C	6A (U _{OUT} = 5V DC)	6A (U _{OUT} = 5V DC)	6A (U _{OUT} = 5V DC)
Efficiency:	> 90%	> 90%	> 74%
Function display (Power LED)	LED green	LED green	LED green
Status relays Sync/Power			
Status relays:	Max. switching current: 1,0A at 30V DC 0,3A at 60V DC 0,5A at 125V AC Max. switching voltage: 60V DC / 125V AC Mechanical switching cycles / at load: 10 Millions / 10.000		

11.3 General Technical Data 6844(RC)

General Data	
Operation:	<ul style="list-style-type: none"> • 6844 <ul style="list-style-type: none"> ○ Via keypad and LCD-Display (illuminated) • 6844RC (Option) <ul style="list-style-type: none"> ○ hmc Manangement Console via serial interface with COM0 or separated optional remote interface • 6844MNG (Option) <ul style="list-style-type: none"> ○ hmc Manangement Console via network with LAN Management board/module 6844MNG ○ WebGUI of the LAN Management board/module via Network
Display:	<ul style="list-style-type: none"> • LCD-Display 2x16 digit • Character height 5mm • Display type: alphanumeric • Background illuminated
Keypad:	<ul style="list-style-type: none"> • 3U/Table-Top/Wall: 25 keys • 1U: 20 keys

Environmental Conditions		
Temperature range:	Operation:	0°C to +55°C At higher temperatures, an active cooling / ventilation is recommended. Other temperature ranges can be obtained from the hopf company.
	Storage:	-20°C to +75°C
Humidity:	max. 95%, not condensed	

CE compliant in accordance with EMC Directive 89/336/EEC and Low Voltage Directive 73/23/EEC	
Safety / Low Voltage Directive:	DIN EN 60950-1:2001 + A11 + Corrigendum
EMC (Electromagnetic Compatibility) / Interference Resistance:	EN 610000-4-2 /-3/-4/-5/-6/-11
Interference voltage EN 55022:	EN 55022 Class B
Interference radiation EN 55022:	EN 55022 Class B

GPS Data	
Receiver type:	12 channel phase tracking receiver, C/A code
Evaluation:	L1 frequency (1575.42MHz)
Sensitivity Acquisition: Tracking:	-143dBm -156dBm
Synchronization time:	<ul style="list-style-type: none"> • Cold start: 5min - 30min (first initialization without position input) • Warm start: < 1min (power down < 3 days)
Antenna connection:	<ul style="list-style-type: none"> • Via BNC connector, female • For active antennas, $U_b = 5V$ DC • Antenna power fed via Board 6844(RC) BNC connector

Backup Clock	
Maintenance free buffering	at least 3 days / typ. 7 days / max. 10 days
Time offset (accuracy)	< ± 2 msec
Crystal accuracy (32.768kHz)	± 25 ppm at +10°C to +50°C

Board 6844	MTBF in [h]	MTBF in Years [a]
Complete Board 6844(RC) incl. GPS receiver	77,767	8.9
Board 6844(RC) incl. GPS receiver without keypad and display	680,000	> 77.6

11.3.1 Internal System Accuracy

General Character	
Aging (system quartz)	< $\pm 5 \cdot 10^{-6}$ / year

GPS-System

Internal System Accuracy (System-PPS) ⁽¹⁾ (absolute to UTC \Rightarrow radiated from GPS)	
Accuracy ⁽²⁾	< ± 150 ns
Jitter ⁽²⁾	< $\pm 3 \cdot 10^{-8}$
Freewheel stability ^(2, 3)	< $\pm 1 \cdot 10^{-7}$

Sub-Master System

Synchronisation source: **DCF77 pulse** (**hopf** GPS System 6844RC)

Internal System Accuracy (System-PPS) ⁽¹⁾	
Accuracy ^(2, 4)	< ± 80 ns
Jitter ⁽²⁾	< $\pm 3 \cdot 10^{-8}$
Free wheel stability ^(2, 3)	< $\pm 1 \cdot 10^{-7}$

Synchronisation Source: **DCF77 pulse** (**hopf** DCF77 System 6855)

Internal System Accuracy (System-PPS) ⁽¹⁾	
Accuracy ^(2, 4)	< ± 1 msec
Jitter ⁽²⁾	< $\pm 10 \cdot 10^{-6}$
Freewheel stability ^(2, 3)	< $\pm 2 \cdot 10^{-6}$

Synchronisation Source: hopfMaster/Slave String every second
(hopf GPS System 6844RC)

Interne System Accuracy (System-PPS) ⁽¹⁾ hopf Master/Slave String every second with ETX at second change at 9600Baud	
Accuracy ^(2, 4)	< + 7µsec
Jitter ⁽²⁾	< ± 3 * 10 ⁻⁶
Freewheel stability ^(2, 3)	< ± 5 * 10 ⁻⁷

Synchronisation Source: hopfMaster/Slave String every minute
(hopf DCF77 System 6855)

Interne System Accuracy (System-PPS) ⁽¹⁾ hopf Master/Slave String every second with ETX at second change at 9600Baud	
Accuracy ^(2, 4)	< ± 60µsec
Jitter ⁽²⁾	< ± 1 * 10 ⁻⁶
Freewheel stability ^(2, 3)	< ± 2 * 10 ⁻⁶

Synchronisation Source: hopfMaster/Slave String + PPS
(hopf GPS System 6844RC)

Interne System Accuracy (System-PPS) ⁽¹⁾	
Accuracy ^(2, 4)	< ± 80ns
Jitter ⁽²⁾	< ± 3 * 10 ⁻⁸
Freewheel stability ^(2, 3)	< ± 1 * 10 ⁻⁷

Comment

- (1) The System crystal frequency is the leading factor for the generation of system-PPS and 1 kHz (msec) and is thus crucial for the system accuracy.
- (2) after at least 30 minutes of continuous synchronization at constant temperature
- (3) after 30 minutes synchronisation loss at constant temperature
- (4) absolute to input signal
- (5) During synchronized operation aging is compensated by the internal crystal control

11.3.2 Signal Outputs

Serial Independent Full-duplex Interfaces in RS232 and RS422 COM0 und COM1		
Serial strings with ETX at second change	Baud rate	Accuracy ETX (at System-PPS)
	2400 Baud	+350µs .. +750µs
	4800 Baud	+240µs .. +450µs
	9600 Baud	+190µs .. +300µs
	19200 Baud	+160µs .. +220µs
hopf Master/Slave String (intern) mit ETX zum Sekundenwechsel	9600 Baud	see System PPS

Signal Outputs (internal)	
System-PPS	<ul style="list-style-type: none"> • Accuracy: see internal system accuracy • Signal level: TTL (5V) • Pulse duration: 10msec
1kHz (msec)	<ul style="list-style-type: none"> • Offset (at System-PPS): $< \pm 2\mu\text{s}$ • Jitter/Stability: see System-PPS • Signal level: TTL (5V) / low active⁽¹⁾
DCF77.SYS pulse	<ul style="list-style-type: none"> • Offset (at System-PPS): $0\mu\text{s} < \text{Offset} < 8\mu\text{s}$ • Jitter/Stability: see System-PPS • Signal level: TTL (5V) / low active⁽¹⁾
DCF77.ADD pulse	<ul style="list-style-type: none"> • Offset (at System-PPS): no Offset • Jitter/Stability: see System-PPS • Signal level: TTL (5V) / low active⁽¹⁾
IRIG-B.(1)	<ul style="list-style-type: none"> • Offset (at System-PPS): see 1kHz (msec) • Jitter/Stability: see 1kHz (msec) • Signal level: TTL (5V) / low active⁽¹⁾
IRIG-B.(2)	<ul style="list-style-type: none"> • Offset (at System-PPS): see 1kHz (msec) • Jitter/Stability: see 1kHz (msec) • Signal level: TTL (5V) / low active⁽¹⁾
Signals from status and pulse output	<ul style="list-style-type: none"> • Offset (at System-PPS): $90\mu\text{s} < \text{Offset} < 110\mu\text{s}$ • Jitter/Stability: $< \pm 5\mu\text{s}$ • Signal level: TTL (5V) / low active⁽¹⁾
RC-Output OUT1-OUT4 (6844RC only)	<ul style="list-style-type: none"> • Offset (at System-PPS): see selected pulse • Jitter/Stability: see selected pulse • Signal level: TTL (5V) / low active⁽¹⁾
Signal Outputs (external)	
DCF77 Antenna Simulation (77.5kHz):	Via BNC connector, female <ul style="list-style-type: none"> • Accuracy: see DCF77.SYS pulse • Signal level: 3-5mV_{pp} at 50Ω • Carrier frequency: 77.5kHz \pm 25ppm

Special production:

Modifications can be made to hardware and software in accordance with customer specifications.



The **hopf** Company reserves the right to modify hardware and software at any time.

Comment

(1) Notification to TTL Low active: $5V = \text{Log}_0 / 0V = \text{Log}_1$

12 Appendix

12.1 Factory-Default Values

The following values are set in the system after triggering a DEFAULT:

Function	Legend, Value
Keyword for System-Keypad	is deleted / deactivated
Keyword for hmc	is deleted / deactivated
Keyword for LAN MNG	is deleted / deactivated
Language of the time display on the LCD display	engl. Day of the week / month abbreviation
Time basis for the LCD display	Local time
Daylight saving time / standard time changeover	deactivated (00 00 0000)
Difference time	+ 00 hours 00 minutes
SyncOFF Timer	00 hours 55 minutes [hex 0037]
GPS reception mode	Position Fix
GPS Position	N 000° 00,0000 / E 000° 00,0000
Status and pulse output configuration (optical coupler)	output: time status (quartz / radio)
DCF77.SYS configuration	time basis: local time [hex 00]
DCF77.ADD Configuration	time basis: UTC [hex 80]
DCF77 High pulse length	200 msec [hex C8]
DCF77 Low pulse length	100 msec [hex 64]
DCF77 TimeOFF Timer	55 minutes [hex 3C]
IRIG-B.(1) digital configuration	local time, not inverted, IEEE1344 [hex 04]
IRIG-B.(1) digital TimeOFF Timer	55 minutes
IRIG-B.(2) digital configuration	UTC, not inverted, IEEE1344 [hex 84]
IRIG-B.(2) digital TimeOFF Timer	55 minutes [hex 3C]
COM0/1 ⇒ phys. Parameter	9600 baud, 8 bit, 1 stop bit, no parity [hex 06]
COM0/1 ⇒ output parameter	time basis: local, output without second forerun, ETX immediately, no delay dependent on baud rate, transmission every second [hex D4]
COM0/1 ⇒ output string	hopf 6021 [hex 00]
COM0/1 ⇒ Mode Byte 3	00 [hex 00]
RC-Pulse configuration IMP 1 .. 4	not inverted; mode 2: time status (radio/quartz)
Digital outputs 1 .. 4 (Routing)	RC output 1: IMP1 digital RC output 2: DCF77.Sys digital RC output 3: IRIG-B.(2) digital RC output 4: DCF77.Add digital
Quartz value	centre of the quartz value [hex 5A00]



The following settings are not changed by activating the default setting:

- SYSTEM-Byte ⇒ Sync.-Mode
- Activation resp. deactivation of the LAN MNG board for 6844RC
- Configuration of the LAN board 7270 / 7271 / 7272 / 7273
- Configuration of the slave line board 7406
- Configuration of the frequency board 7530

12.2 GPS (Global Positioning System)

Satellites circumnavigate the earth about twice per day at an altitude of approximately 20,000 km, on 6 different courses and at different angles.

The GPS system was developed based on 18 satellites with 3 replacement satellites. In order to prevent short-term gaps in coverage the number was increased during development to 21 satellites with 3 replacement satellites. Above any point on the skyline, therefore, there are always between 6 and 11 satellites visible. Highly precise atomic clocks are on board every satellite (accuracy min. $1 \cdot 10^{-12}$).

A base frequency of 10.23 MHz is taken from the atomic clocks. The two carrier frequencies used, L1 and L2, are produced from this base frequency.

- Transmission frequency L1 = $154 \cdot \text{Base frequency} = 1575.42 \text{ MHz}$
- Transmission frequency L2 = $120 \cdot \text{Base frequency} = 1227.60 \text{ MHz}$

Each satellite sends all important navigation and system data by modulation on these two carrier frequencies. In the public domain, data transmitted on L1 frequency may be evaluated. The precise time can be calculated from this data by defining the position via the antenna.

The GPS antenna receives the signals of all satellites that are within sighting range above the skyline and forwards them to the GPS receiver via a coaxial cable. 4 satellites are required for continuous time evaluation.

hopf GPS radio-controlled clocks have a **Position-fix function** for difficult antenna positions that do not permit continuous reception from 4 satellites (where satellite signals may be screened by surrounding buildings or in mountain valleys, for example). This function also permits synchronization with only one satellite.

Time calculation

The GPS receiver calculates world time UTC (Universal Coordinated Time) from GPS world time (GPS-UTC) radiated by the satellite, by subtracting the leap seconds; at present (status: January 1999) world time is running 13 seconds behind GPS-UTC time. The difference is not constant and changes with the insertion of leap seconds.

The current standard time for the respective time zone is calculated by the addition of a time offset to the UTC time. The time offset is the time difference between UTC time and the time zone in which the clock system is situated, is set in the clock system by the user during commissioning of the clock.

Any daylight saving time (DST) changeover that is due in the time zone is carried out via a switching function that is to be configured in the clock system.

Advantages/Disadvantages GPS:

- + High accuracy
- + High security against interference
- + Worldwide application possible
- + High security against failure (terrestrial transmitters are often switched off when bad weather conditions prevail at the transmission location)
- + High independent clock accuracy
- Outdoor antenna required
- Limited antenna cable lengths

12.3 DCF77 (German Long-Wave Transmitter Frankfurt 77.5kHz)

DCF77¹ is a time signal that is radiated via a terrestrial long-wave transmitter in Frankfurt, Germany, with a carrier frequency of 77.5kHz.

The transmission of the data is amplitude modulated whereas the transmission of the time information is bit serial.

12.3.1 DCF77 General

The DCF77 signal transmits central European time (CET) or central European summer time (CEST). This time is calculated from UTC plus one hour (CET) or two hours (CEST).

The DCF77 signal contains complete time information: minute, hour, day-of-week and date. The following information is transmitted:

- Local time
- Current time zone (daylight saving time or standard time)
- Announcement bit for daylight saving time (DST) changeover
- Announcement bit for the leap second

If UTC is to be calculated from the local time transmitted by DCF77 then the receiver must know the time offset (local time to UTC). In the CET zone this is +1 hour in an easterly direction. A **hopf** system calculates the correct UTC time from the local time, via the internally set time offset and the DST changeover points.

12.3.1.1 DCF77 Signal Structure

The complete time information is transmitted in every minute. A part of time information is transmitted every second of every minute, with the exception of the 59th second. The missing signal in this second gives notice of an impending minute change in the next second.

The amplitude of the 77.5kHz carrier frequency is reduced from 100% to 25% at the beginning of every second for a duration of 100 or 200ms (amplitude modulation). The beginning of each reduction marks the precise second change.

The duration of reductions of 100 and 200ms (binary 0 and 1) is converted into a BCD code and in this way decodes the transmitted time telegram.

The data string is sub-divided into different groups. Three of them followed by a parity check:

- P1 = parity of minutes
- P2 = parity of hours
- P3 = parity of current day-of-year, day-of-week, month and year

The binary 1s' of a group are calculated and supplemented with the parity bit to form an even number.

When valid time information is transferred from CEST, the 17th second mark has a duration of 200ms. One hour before changeover from CEST to CET, or vice-versa, the 16th second mark has a duration of 200ms.

¹ DCF77: **D** = Deutscher (German), **C** = Long-wave transmitter, **F** = Frankfurt, **77** = frequency

The coding is shown in the following illustration:

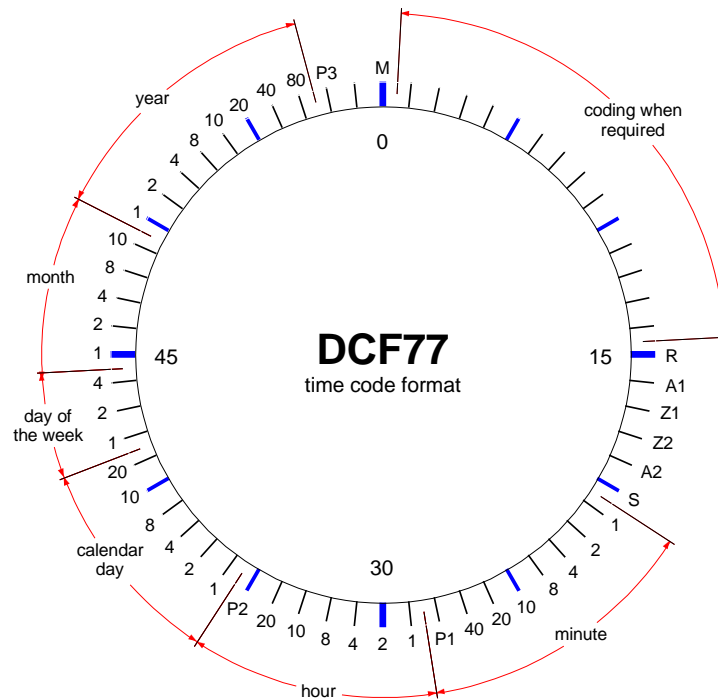

- M** Minute mark (100msec.)
- R** The second mark no. 15 has a duration of 200msec. when radiation takes place via the standby antenna.
- A1** Announcement of an imminent change from CET to CEST or vice-versa.
- Z1, Z2** Time zone bits
- A2** Announcement of a leap second
- S** Start bit of the coded time information
- P1, P2, P3** Test bits

12.3.1.2 Advantages and Disadvantages DCF77

- + DCF77 receivers are generally less expensive than GPS receivers
- + Reception of the legal time in Germany
- + The antenna can be installed inside a building under favorable conditions (no lightning protection or expensive laying of antenna cable is necessary)
- Sensitive to interference signals (atmospheric interference or radiation from electric motors, monitors or other switched, inductive loads)
- Installation limited to within approx. 1500km of Frankfurt, Germany
- Transmitter may be switched off when there is bad weather at the transmission location
- Lower short-term accuracy when compared with GPS

12.3.2 DCF77 Generation by *hopf* Clocks

hopf clocks can simulate the DCF77 signal for other clocks in order to operate DCF77 clocks in locations where the DCF77 signal is not available.

This can be realized as DCF77 antenna simulation (77.5kHz) and also as DCF77 pulse (1Hz).

12.3.2.1 DCF77 Signal Simulation

An analogue, amplitude-modulated carrier signal is generated by the clock system. A connected, standard DCF77 radio-controlled clock is unable to differentiate this signal from an "original" DCF77 signal received via an antenna. It is also possible to use time bases other than only CET/CEST to simulate the signal.

The term **DCF77 Antenna Simulation** or, in short, **DCF77 Sim** is commonly used in *hopf* literature to describe this term.

12.3.2.2 DCF77 Pulse (1Hz)

The DCF77 pulse uses the same coding procedure as that used by the DCF77 signal radiated by the transmitter. The difference lies in the fact that an amplitude-modulated carrier signal is not used for transmission. The 100 and 200msec. long reductions are represented by logical signal levels.

In this digital form the signal can then also be transmitted via a fiber optic cable, for example.