

Installation Instructions for the 103SR Series Hall-Effect Position Sensor

ISSUE 3

PK 88782

GENERAL INFORMATION

103SR Series Hall-effect position sensors are completely sealed in threaded aluminum bushings, and meet NEMA 3, 3R, 3S, 4, 4X, 12 and 13 requirements.

Output can be directly connected to most electronic circuitry such as microprocessors, integrated logic, discrete transistors and SCRs with compatible voltage specifications.

ABSOLUTE MAXIMUM RATINGS*

Parameters	4.5 VDC to 5.5 VDC	6 VDC to 24 VDC	4.5 VDC to 24 VDC
Supply Voltage (Vs)**	-1.2 VDC to +10 VDC	-1.2 VDC to +24 VDC	-1.0 VDC to +25 VDC
Voltage Externally Applied to Output	+10 VDC max. (OFF only) -0.5 VDC min. (ON or OFF)	+20 VDC max. (OFF only) -0.5 VDC min. (ON or OFF)	+25 VDC max. (OFF only) -0.5 VDC min. (ON or OFF)
Output Current	20 mA max.	40 mA max.	20 mA max.
Temperature Operate & Storage	-40°C to +100°C (-40°F to +212°F)	-40°C to +100°C (-40°F to +212°F)	-40°C to +100°C (-40°F to +212°F)

* Absolute maximum ratings are the extreme limits that the device will withstand without damage to the device.

However, the electrical and magnetic characteristics are not guaranteed as the maximum limits (above recommended operating conditions) are approached, nor will the device necessarily operate at absolute maximum rating.

** Vs is the unregulated supply voltage.

TABLE 1 LEADWIRE LENGTH

Catalog Listing	Description
103SR11A-1	152,4 mm (6 in.), Type 1
103SR11A-2	1 meter (39.37 in.), Type 2
103SR11A-3	203,2 mm (8.0 in.), Type 1
103SR12A-1	152,4 mm (6 in.), Type 1
103SR12A-2	1 meter (39.37 in.), Type 2
103SR12A-3	1,52 meters (60 in.), Type 1
103SR12A-4	304,8 mm (12 in.), Type 1
103SR12A-7	3,66 meters (12 ft.), Type 2
103SR12S-2	1 meter (39.37 in.), Type 2
103SR13A-1	152,4 mm (6 in.), Type 1
103SR13A-2	1 meter (39.37 in.), Type 2
103SR13A-4	1 meter (39.37 in.), Type 1
103SR13A-6	3,05 meters (120 in.), Type 1
103SR13A-8	1 meter (39.37 in.), Type 2 w/SST bushing
103SR13A-9	3 meters (118 in.), Type 3
103SR13A-10	142,24 mm (5.60 in.), Type 2
103SR13A-11	1 meter (39.37 in.), Type 3
103SR13A-12	2005,58 mm (78.96 in.), Type 2
103SR13A-13	152,4 mm (6 in.), Type 1
103SR13A-14	304,8 mm (12 in.), Type 1
103SR13A-16	355,6 mm (14 in.), Type 1
103SR14A-1	152,4 mm (6 in.), Type 1
103SR14A-2	1 meter (39.37 in.), Type 2
103SR17A-1	152,4 mm (6 in.), Type 1
103SR17A-2	1 meter (39.37 in.), Type 2
103SR18-1	99,1 mm (3.9 in.), Type 4

TABLE 2 LEADWIRE TYPE

Type	Description
Type 1	24 gage stranded, irradiated Polyethylene insulated
Type 2	22 gage PVC insulated conductor with black molded PVC jacket
Type 3	22 gage insulated conductors with yellow thermoplastic polyurethane jacket
Type 4	24 gage irradiated polyethylene

CAUTION

PRODUCT DAMAGE

- Do not reverse supply voltage polarity
- Do not exceed maximum ratings

Failure to comply with these instructions may result in product damage.

ELECTRICAL AND MAGNETIC SPECIFICATIONS

Refer to Table 1 (Page 1) for leadwire lengths available to individual catalog listings, then order accordingly.
Refer to Table 2 (Page 1) for explanation of different leadwire types.

Listing	103SR11A-x	103SR12A-x	103SR13A-x	103SR14A-x	103SR17A-x	103SR18-x
Supply Voltage	4.5 VDC - 5.5 VDC	6 VDC - 24 VDC	4.5 VDC - 24 VDC	4.5 VDC - 24 VDC	4.5 VDC - 24 VDC	4.5 VDC - 24 VDC
Supply Current	4 mA max.	10 mA max.	10 mA max.	10 mA max.	10 mA max.	10 mA max.
Output Type	Source (PNP)	Source (PNP)	Sink (NPN)	Sink (NPN)	Sink (NPN)	Sink (NPN)
Output Voltage	(Vs - 1.5) V max.	(Vs - 1.5) V max.	0.4 V max.	0.4 V max.	0.4 V max.	0.4 V max.
Output Current	20 mA max.	20 mA max.	20 mA max.	20 mA max.	20 mA max.	20 mA max.

Magnetic Gauss*

Type	Unipolar	Unipolar	Unipolar	Unipolar	Bipolar	Latching
0° C to 70° C Temperature Range						
Max. Op.	735	495	475	—	180	90
Min. Rel.	25	120	135	—	-180	-90
Min. Dif.	50	40	40	—	40	40
-40° C to 100°C Temperature Range						
Max. Op.	—	—	495	160	205	120
Min. Rel.	—	—	200	5	-205	-120
Min. Dif.	—	—	35	8	35	40
+25°C Typ.						
Typ. Op.	350	350	400	90	50	50
Typ. Rel.	215	245	250	45	-50	-50
Typ. Dif.	135	85	85	45	100	80

* Unipolar: sensor has plus maximum operate point, plus minimum release point. One magnetic pole (south) is required to operate and release a unipolar sensor.

Bipolar sensor has plus (south pole) operate point and minus (north pole) minimum release point. Operate and release points can be both positive or both negative. **Latching cannot be guaranteed.** Ring magnets are usually used with bipolar sensors.

Bipolar latching sensor is guaranteed to switch on with plus (south pole) gauss only, and switch off with negative (north pole) gauss only.

INTERFACING SENSING AND CONTROL HALL EFFECT SENSORS

The schematics shown are typical of the outputs with which Sensing and Control Hall effect sensors can be interfaced. Values shown are representative only.

CURRENT SINKING OUTPUTS

(Current flows through load into sensor.) Output terminal is open collector. In the unoperated condition ($I_L = 0$), the output voltage is normally high.

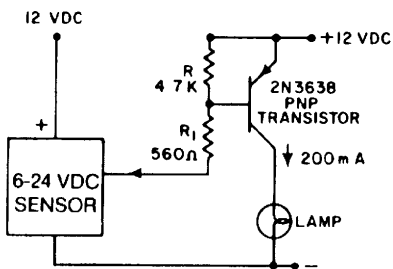
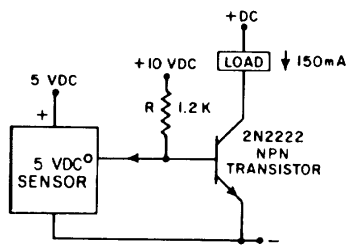
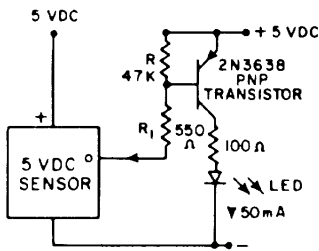
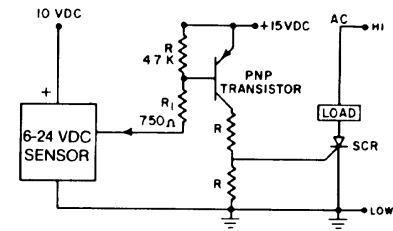

CURRENT SOURCING OUTPUTS

(Current flows from sensor through load.) Output terminal is open emitter. In the unoperated condition ($I_L = 0$), the output voltage is normally low.

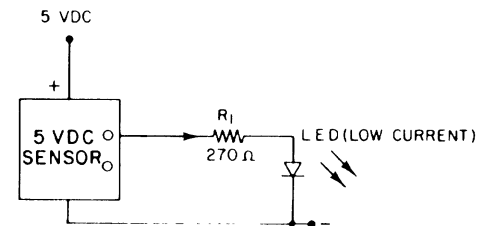
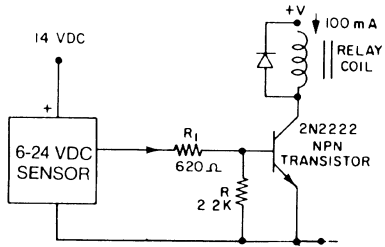
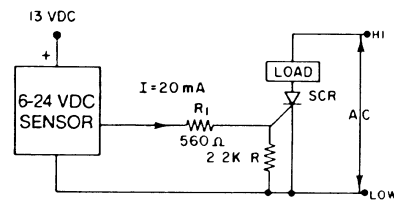
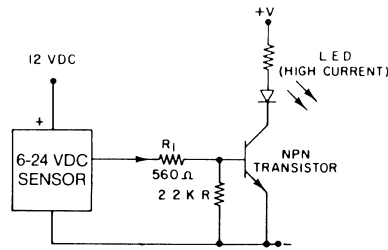

TROUBLESHOOTING

If sensor does not operate, follow these steps:

1. Assure wiring is correct. Load must be connected.
2. Measure supply voltage across Red (+) and Black (-) leads to verify presence of proper voltage.
3. Connect positive voltmeter lead to Green (output) lead, and negative voltmeter lead to Black (ground). With magnet removed (or north pole present), reading should be:

Catalog Listing	Voltage Reading
103SR11A-1	0
103SR12A-1	0
103SR13A-1	Vs
103SR14A-1	Vs
103SR17A-1*	Vs

When magnet (south pole) moves toward sensor face (beyond operating point), output should change state and read:

Catalog Listing	Voltage Reading
103SR11A-1	3.4 V min.
103SR12A-1	(Vs - 2)V min.
103SR13A-1	0.4 V max.
103SR14A-1	0.4 V max.
103SR17A-1*	0.4 V max.

*North magnetic pole must be present to ensure device is OFF due to bipolar magnetic operation.

WARRANTY/REMEDY

Honeywell warrants goods of its manufacture as being free of defective materials and faulty workmanship. Contact your local sales office for warranty information. If warranted goods are returned to Honeywell during the period of coverage, Honeywell will repair or replace without charge those items it finds defective. The foregoing is Buyer's sole remedy and is **in lieu of all other warranties, expressed or implied, including those of merchantability and fitness for a particular purpose.**

Specifications may change without notice. The information we supply is believed to be accurate and reliable as of this printing. However, we assume no responsibility for its use. While we provide application assistance personally, through our literature and the Honeywell web site, it is up to the customer to determine the suitability of the product in the application.

For application assistance, current specifications, or name of the nearest Authorized Distributor, contact a nearby sales office. Or call:

1-800-537-6945 USA

1-800-737-3360 Canada

1-815-235-6847 International

FAX

1-815-235-6545 USA

INTERNET

www.honeywell.com/sensing

info.sc@honeywell.com

MOUNTING DIMENSIONS

(for reference only)

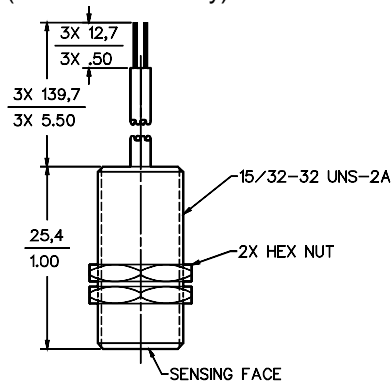

LEADWIRE COLOR CODE

Color	Description
Stranded	
Red	Vs (+)
Black	Ground (-)
Green	Output
Cable	
Red	Vs (+)
Black	Ground (-)
White (Type 2)	Output (digital)
Brown (Type 3)	Output (linear)

Honeywell

Sensing and Control

Honeywell Inc.
11 West Spring Street
Freeport, Illinois 61032



Printed with Soy Ink
on 50% Recycled Paper

PK 88782-3-EN IL50 GLO 0303 Printed in USA

www.honeywell.com/sensing