



DE-STA-CO - Montageanleitung / Assembly instructions / Instrucciones de montaje
 Grundelement / Basic element / Elemento básico

BAGE-0054

Blatt 1/2 Rev.2

ersetzt Rev. 1

Für alle Lagerstellen und Laufflächen,
 ausgenommen selbstschmierende Lagerbuchsen:
 for all bearings and running surfaces,
 except self-lubricating bearings:
 Para todos los cojinetes y superficies de contacto,
 excepto casquillos autolubricantes:

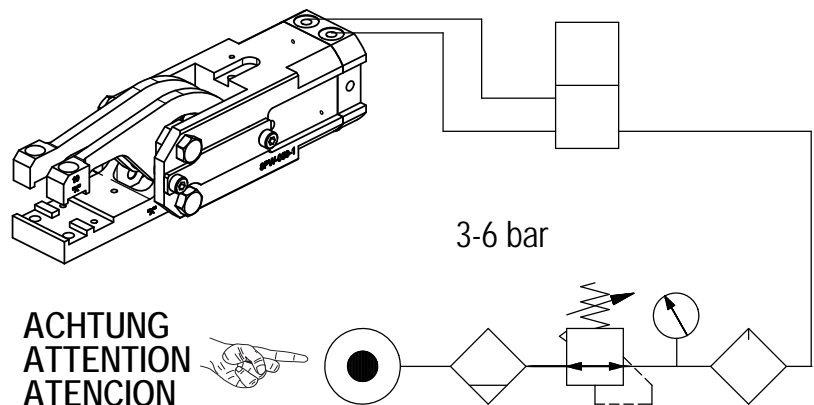
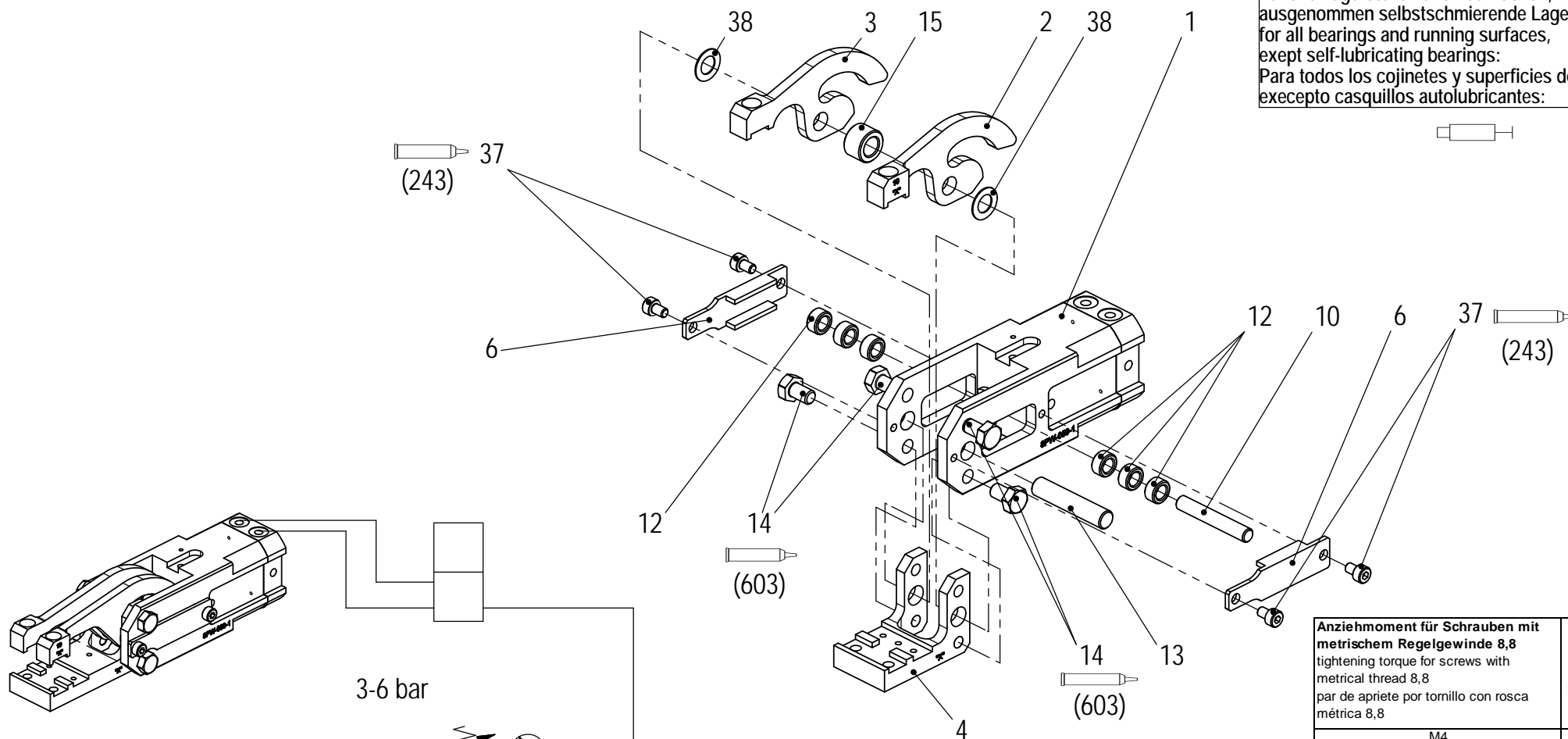

Anziehmoment für Schrauben mit metrischem Regelgewinde 8,8 tightening torque for screws with metrical thread 8,8 par de apriete por tornillo con rosca métrica 8,8	MA (Nm)
M4	3
M5	5,9
M6	10
M8	25
M10	49
M12	85

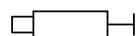

Schmierfett / Lubricant / Lubricante:
 ARAL-Langzeitfett H Typ KP 2K/30
 ARAL-long-time grease H type KP 2K/30
 ARAL-Grasa de larga duración H tipo KP 2K/30

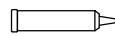

Loctite



Montageanleitung
 Assembly instructions
 Instrucciones de montaje

siehe Ersatzteilliste
 see spare parts list
 véase lista de piezas de recambio



Anziehdrehmoment
 tightening torque
 par de apriete

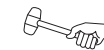

Öffnen bei Druckluftausfall
 open in case of pressure failure
 abrir en caso de falta de presión



DE-STA-CO - Montageanleitung / Assembly instructions / Instrucciones de montaje
 Grundelement / Basic element / Elemento básico

BAGE-0054

Blatt 2/2 Rev.2

ersetzt Rev. 1

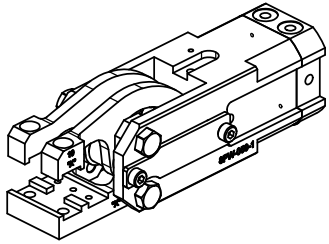

84A2-11
84AT2-11

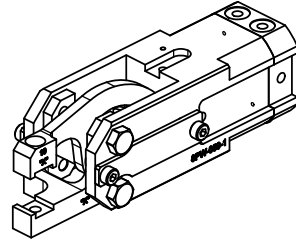

84A2-14
84AT2-14

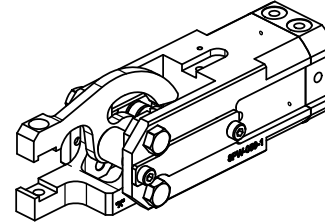

84A2-16
84AT2-16

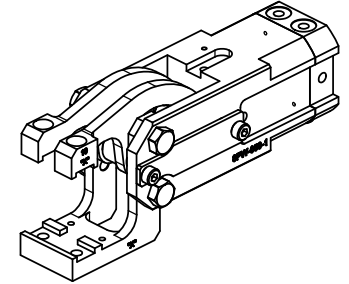

84A2-17
84AT2-17

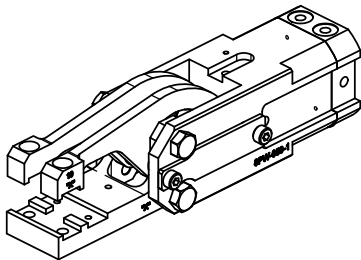

84A2-18
84AT2-18

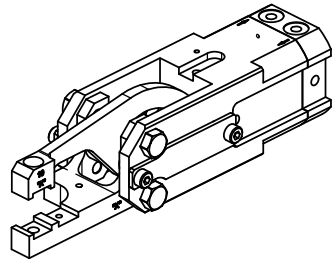

84A2L-18
84AT2L-18

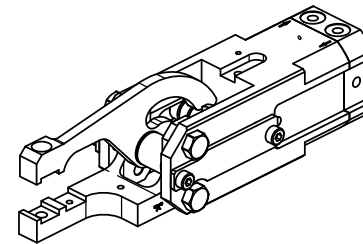

84A2R-18
84AT2R-18

Anziehmoment für Schrauben mit metrischem Regelgewinde 8,8 tightening torque for screws with metrical thread 8,8 par de apriete por tornillo con rosca métrica 8,8	MA (Nm)
M4	3
M5	5,9
M6	10
M8	25
M10	49
M12	85

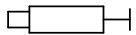

Schmierfett / Lubricant / Lubricante:
 ARAL-Langzeitfett H Typ KP 2K/30
 ARAL-long-time grease H type KP 2K/30
 ARAL-Grasa de larga duración H tipo KP 2K/30

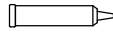

Loctite



Montageanleitung
 Assembly instructions
 Instrucciones de montaje

siehe Ersatzteilliste
 see spare parts list
 véase lista de piezas de recambio

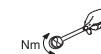

Anziehdrehmoment
 tightening torque
 par de apriete

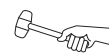

Öffnen bei Druckluftausfall
 open in case of pressure failure
 abrir en caso de falta de presión