



□ Operating Manual

1. Intended Use

Line or outlet pressure regulators- /reducer for Air, gases and liquids which is designed to effect reduction to a downstream pressure independent of the flow rate. Not for use as a flow controller or as a shut-off valve. The regulators from series **R102** are self-contained, spring loaded pressure reducing regulators.

The general function of pressure regulators is shown in the movie link!

[Movie pressure regulators](#)

2. Information on Instructions for use

Any use of the device requires full understanding and strict observation of these instructions. The device is only to be used for purposes specified here.

2.1. Symbole



This symbol points to special data and/or rules and prohibitions concerning damage precaution. These instructions are important for working safety!



This symbol identifies important instructions/regulations or in case of property damage danger.

3 Safety



3.1 Safety Instructions

Do not endanger yourself and other people. Please read the following safety instructions before performing installation, operation and maintenance of fittings. They enable to avoid dangers to people and units. Handling of technical gases – especially flammable or toxic gases – requires knowledge of the subject, observation of instructions for use and special safety measures. In addition, regulations and rules must be followed as applicable. (see 3.2)

Use these units only as intended (see section “Intended Use”). The same is valid for the used gas: improper use can cause damage of the unit or injury and even death of persons.

Use gas detection devices, if you work with dangerous gases. These products detect leakage and warn the personnel.

Wear gas mask, protection glasses and protection gloves, if you work with toxic gases and provide good ventilation. Make sure that venting openings are not clogged and toxic gases will be discharged in use with pressure reducer and plants equipped with relief valves.

Some gases can cause suffocation, because they displace oxygen from air. Ensure good ventilation, if you work with these gases. It is recommended to install detectors which give an alarm if there is a lack of oxygen at the working place.

Oil and grease must never be used at gas control units. Oil and grease ignite easily and can intensely react with some gases under pressure. **In special cases greases can be used, which are specified for the corresponding application.**

The use of AirCom regulator for oxygen applications is permitted only with signed units.

Special safety instructions for pressure reducers.

If devices are connected with the pressure reducer ensure via separate protection equipment that no dangerous pressure will be built up in them. The relief valve of the pressure reducer (if available) is not applicable for these devices as protection means.

When using cylinder pressure reducers the pressure reducer connector must directly mate with the cylinder valve connection. The use of adaptors is not permitted.

When changing the gas type the pressure reducer must be sufficiently purged with inert gas.

3.2 Regulations and Rules



The national rules and regulations concerning the handling of:

- compressed gases
- toxic gases
- flammable gases

are to be observed.

4 Installation

4.1 Transport and Packing

Please check directly after delivery the pressure reducer for any transport damages and deficiencies

The port openings of the pressure reducer are often closed via hole plugs to prevent contamination with dirty particles. Remove plugs just before the assembly.

In case of further disassembly close the port openings again before storing or transporting. Temporarily it can be done using a strip of adhesive tape by sticking it to the opening.

The pressure reducer (e. g. dispatch to customer service) may only be transported in an appropriate, stable packing.

4.2 Preparation

- Turn hand knob of pressure reducer counter clockwise until the range spring is complete released.
- Attach pressure reducer - make sure that connections threads are matching.
- To ensure that the regulator works properly, all lines have to be purged prior to installing the regulator. Deposits and other foreign objects can damage the valve seat and influence the regulator's behaviour.

Do not use any lubricants since this would contaminate the pressure reducer and, in the case that oxygen or nitrous oxide is used, there is danger of combustion.

The regulator has to be installed in the line in such a way that the air flows in the direction of the arrows on the housing (IN to OUT).

An internal filter is provided only to stop random contamination resulting from the installation of the regulator; an auxiliary upstream filter is recommended for use in all but the cleanest of media. Gaseous media should be free of excessive moisture to prevent icing of the regulator at high flow rates.

4.3 Operation

Controlled outlet pressure settings are obtained by adjusting the control knob. Rotating the knob clockwise raises the outlet pressure while a counterclockwise rotation coupled with venting of the downstream side of the regulator plumbing lowers the outlet pressure. Final adjustment should be made in the direction of increasing pressure to obtain the most accurate set points. These regulators will operate with any liquid or gaseous media compatible with the wetted materials.

Pressure regulators Series 231; 232; 233; 239 and R13 are factory setted. The range can't be changed and range spring can't released.

The general function of pressure regulators is shown in the movie link!

[Movie pressure regulators](#)

Final adjustment should be made in the direction of increasing pressure to obtain the most accurate set points. These regulators will operate with any liquid or gaseous media compatible with the wetted materials. Satisfy yourself that the pressure reducers will only be used within their admissible limiting value (see technical data). Operating outside the nominal temperature range could destroy the sealings.

Warning:

By placing and locking the handknob at a corresponding position on the adjusting screw or by placing and locking the adjusting screw at a corresponding position against the bonnet, the maximum output pressure of some regulator types can be increased to a value considerably higher than the maximum output pressure signed on the unit. Using a regulator with a output pressure considerably higher than the output pressure specific by the manufacturer may have the following consequences:

- a load spring compressed nearly to solid height has a different characteristic than an elongated spring, this may negatively affect the regulator's controlling function (the harshly compressed loadspring may prevent a complete shutoff of the main valve, the regulator would show creep). - At the risk of their permanent deformation
- internal regulator parts are exposed to stresses beyond their design. Damages caused by excessive back pressure setting are excluded from warranty.

4.4 Shut-Down Actions

- Close inlet valve.
- Use up the remaining gas or drain completely.
- Turn hand knob counterclockwise until the spring is completely uncharged

5 Maintenance

 **Do not carry out any maintenances / repairs if the pressure reducer will be under pressure.** The maintenance and repair may only be performed by trained experts! The inspection is recommended every 6 months if a system has a normal duty cycle. The device is checked for outside damages and function. More frequent maintenance may be necessary when the system is used under extreme conditions.

5.2 Trouble Shooting

When performing necessary corrective action in the following operations, refer to the "Maintenance" section for the necessary procedure.

1. Problem:

The regulated pressure continues to increase after lock up without a change in control knob position.

Possible cause: Valve seat needs replacement

2. Problem:

Leakage through or around edge of bonnet

Possible cause:

1. Torque on bonnet is insufficient. Retorque bonnet.
2. Inspect for nicks and scratches on piston / diaphragm

Replace diaphragm and/or piston (repairkit)

5.3 Spare Parts

Only original spare parts must be used for repair or overhaul. Replacement only by trained personnel!

You find the repairkits under www.aircom.net

5.4 Repairs

Faulty / damaged units can be send back to AirCom Pneumatic GmbH. After checking the unit we will send you a cost estimate with a first diagnostic. Regulators wich were not in use with air or neutral gases have to be cleaned before you send them back for repair. Furthermore please note the used medium and a short error discription on the delivery note.

| | | |
|---------------------------|--|------------------------------|
| Description | Provides precision regulation in high flow and high relief applications. A sensitive rolling diaphragm and balanced inner valve assure constant outlet pressure even with supply pressure and flow fluctuations. | |
| Media | compressed air or non-corrosive gases | |
| Supply pressure | max. 18 bar, optionally max. 35 bar | |
| Accuracy | response sensitivity: < 2 mbar | |
| Air consumption | 0.5% of volume flow, max. 15 l/min | |
| Adjustment | by T-handle with locknut | |
| Relieving function | relieving, optionally non-relieving | |
| Relief capacity | 1200 l/min at 1.5 bar outlet and 0.35 bar overpressure above setpoint | |
| Gauge port | G¼ for outlet pressure | Mounting position any |
| Temperature range | 0 °C to 90 °C / 32 °F to 194 °F, for appropriately conditioned compressed air down to -40 °C / -40 °F | |
| Material | Body: aluminium die-cast Elastomer: NBR/Buna-N, optionally FKM at 35 bar version Inner valve: stainless steel, brass, aluminium and steel | |

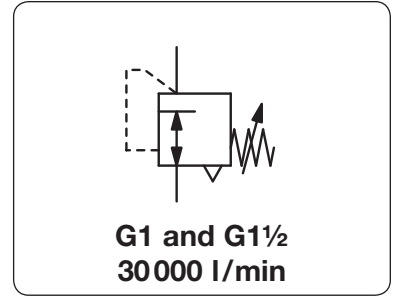

| Dimensions | | | K _v -value (m³/h) | Flow rate m³/h*1 l/min*1 | Connection thread G | Pressure range bar | Order number |
|------------|---|---|---------------------------------|-----------------------------|------------------------|-----------------------|--------------|
| A | B | C | | | | | |

| Precision pressure regulator | | | | | | | supply pressure max. 18 bar, relieving, with constant bleed | R102 |
|------------------------------|-----|----|------|------|-------|-----|---|----------|
| 141 | 287 | 56 | 11.4 | 1680 | 28000 | G1 | 0.001 ... 0.7 | R102-081 |
| | | | | | | | 0.03 ... 2.0 | R102-08A |
| | | | | | | | 0.07 ... 4.0 | R102-08B |
| | | | | | | | 0.14 ... 7.0 | R102-08C |
| | | | | | | | 0.14 ... 10 | R102-08D |
| 141 | 287 | 56 | 12.2 | 1800 | 30000 | G1½ | 0.001 ... 0.7 | R102-121 |
| | | | | | | | 0.03 ... 2.0 | R102-12A |
| | | | | | | | 0.07 ... 4.0 | R102-12B |
| | | | | | | | 0.14 ... 7.0 | R102-12C |
| | | | | | | | 0.14 ... 10 | R102-12D |

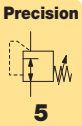

| Special options, add the appropriate letter | | |
|---|---|--------------|
| NPT | connection thread | R102-... N |
| non-relieving | and without constant bleed | R102-... K |
| supply pressure 35 bar | free of non-ferrous metal, FKM elastomer | R102-... X62 |
| tamper-proof cap | aluminium, adjustment by screwdriver, total height 295 mm | R102-... T |

| Accessories | | |
|-------------------------|-------------------------|--------------|
| pressure gauge | Ø 63 mm, 0...*2 bar, G¼ | MA6302-...*2 |
| mounting bracket | made of steel | BW00-30 |

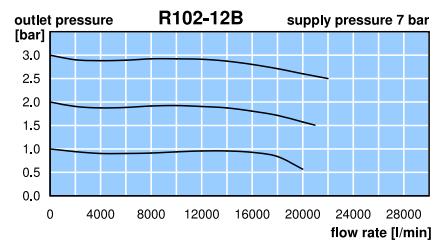
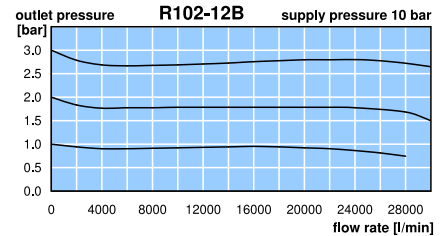
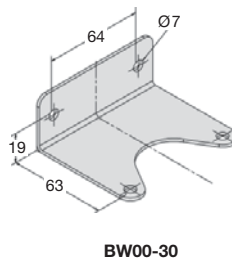
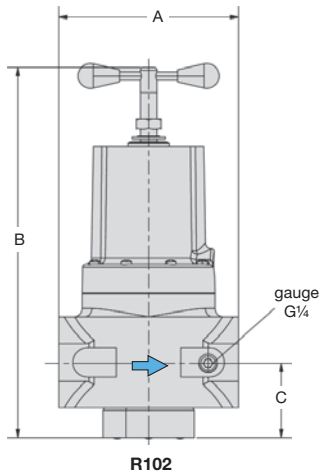
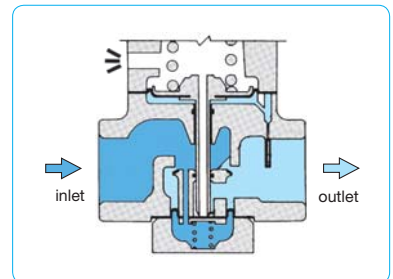

*1 at 10 bar supply pressure and 2.8 bar outlet pressure
*2 01 = 0...1 bar, 02 = 0...2.5 bar, 04 = 0...4 bar, 10 = 0...10 bar