

Magnetostrictive linear position sensor, rod design
LTX2000M-R10-SSi-2-GAF1-X3-H1161

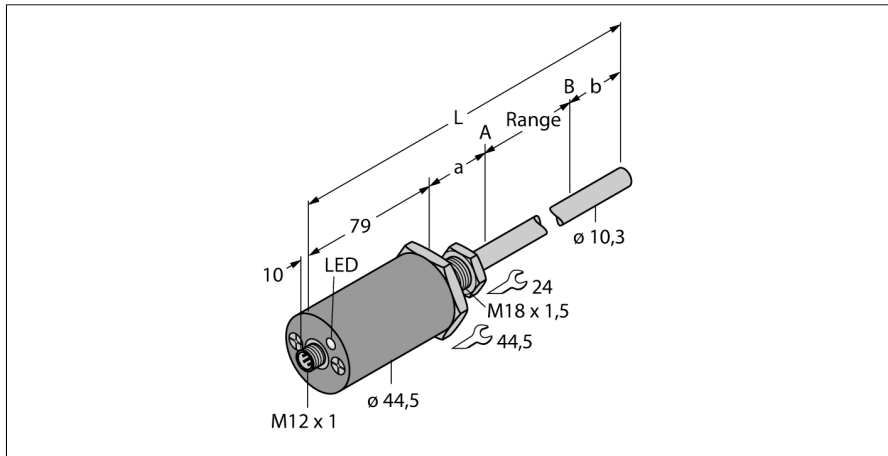

- Suited for hydraulic cylinders
- The sensor is pressure resistant up to 340 bar (permanent), 680 bar (short-term)
- Shock-proof up to 1000g
- Status displayed via 3-colour LED
- Resolution 0.005mm
- Operating temperature rod -40°... +105°C
- Operating temperature electronics -40°... +85°C
- Protection class IP68
- 7...30 V DC power supply
- SSI - output, gray coded, 25 bit
- M12 x 1 connector

Type code	LTX2000M-R10-SSi-2-GAF1-X3-H1161
Ident no.	1543048
Measuring range [A...B]	2000mm
Resolution	0,005 mm
blind zone a	50.8 mm
blind zone b	63.5 mm
Repeatability	≥ ± 0.005 mm
Linearity deviation	≤ 0.01 %
Hysteresis	≤ 0.025 mm
Ambient temperature	-40...+105 °C
Operating voltage	7...30VDC
Residual ripple	≤ 10 % U _s
No-load current I ₀	≤ 40 mA
Short-circuit protection	yes/ cyclic
Output function	6-wire, SSI, 25 Bit, Gray, asynchronous, Forward
Design	cylindrical/smooth, R10
Dimensions	2193 mm
Housing material	metal, AL, black
Material active area	Metal, VA
Connection	male, M12 x 1
Vibration resistance	30 Hz (1 mm)
Shock resistance	1000 g (11 ms)
Protection class	IP68
Measuring range display	multifunction LED

Wiring diagram

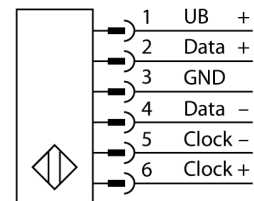

Functional principle

The LTX-R10 is a magneto-strictive sensor, optimized for precise position control in hydraulic cylinders. With the assistance of optional floats, the magnetically actuated position sensors also implement additional fill level monitoring.

The absolute value sensor is very robust and precise, and also saves the position information in the event of a voltage failure, so that additional zeroing is unnecessary. The sensors operate on the non-contact function principle and are thus wear and maintenance free.

**Magnetostrictive linear position sensor, rod design
LTX2000M-R10-SSi-2-GAF1-X3-H1161**

Accessories

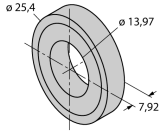
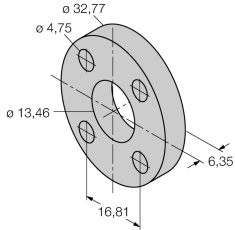
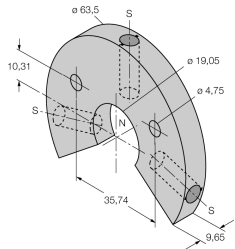
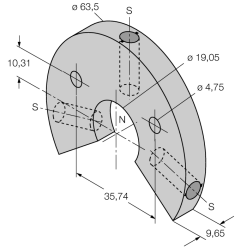
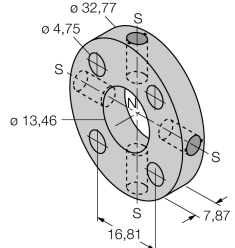
Type code	Ident no.	Description	Dimension drawing
CM-R10	6900416	standard cylinder magnet	
STS-R10	6900411	Standard spacer disc It consists of non-ferritic metal and is used to separate the positioning magnet from the head piece of the hydraulic piston rod.	
LSPM-AL-R10	6900414	large ring magnet with slot, aluminium	
LSPM-SS-R10	6900415	Large ring magnet with slot, stainless steel	
STM-AL-R10	6900409	standard 4-hole magnet, aluminium	

**Magnetostrictive linear position sensor, rod design
LTX2000M-R10-SSi-2-GAF1-X3-H1161**

Accessories

Type code	Ident no.	Description	Dimension drawing
SPM-AL-R10	6900412	Small ring magnet with slot, aluminium	
SPS-R10	6900413	spacer disk for ring magnet with slot	
EF-R10	6900417	Float magnet, stainless steel, specific weight 0.62	
MF-R10	6900418	Small float, stainless steel, specific weight 0.66	
MB-R10	6900419	Sensor head fixing clamp	

**Magnetostrictive linear position sensor, rod design
LTX2000M-R10-SSi-2-GAF1-X3-H1161**

TURCK

Industrial
Automation

Accessories

Type code	Ident no.	Description	Dimension drawing
RB-R10	6900420	Rod fixing clamp	
LB-R10	6900421	Magnet fixing clamp	
WAK4.5-2/P00	8008576	5-pole female M12 x 1 connector without LED	