

QS30LDQP

Photoelectric Sensor – Diffuse Mode Sensor

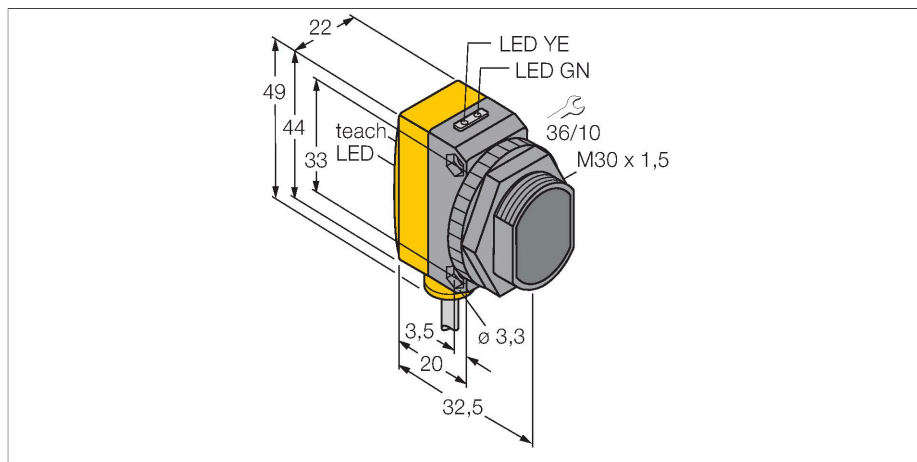

Technical data

Type	QS30LDQP
ID	3072682
Optical data	
Function	Proximity switch
Operating mode	Diffuse
Light type	Red
Wavelength	650 nm
Laser class	▲ 1
Beam diameter	2 mm
Range	0...400 mm
Electrical data	
Operating voltage	10...30 VDC
Residual ripple	< 10 % U _{ss}
DC rated operational current	≤ 150 mA
No-load current	≤ 35 mA
Short-circuit protection	yes
Reverse polarity protection	yes
Output function	NO contact, PNP/NPN
Switching frequency	≤ 1000 Hz
Readiness delay	≤ 1 s
Readiness delay	≤ 1000 ms
Response time typical	< 0.5 ms
Setting option	Push Button Remote Teach
Mechanical data	
Design	Rectangular with thread, QS30
Dimensions	Ø 30 x 35 x 22 x 49 mm

Features

- Cable with male end, M12 × 1, 5-pin, PVC, 150 mm
- Protection class IP67
- LED all-round visible
- Teach button
- 8-segment bargraph
- Operating voltage: 10...30 VDC
- Switching output, bipolar
- Light or dark operation

Wiring diagram

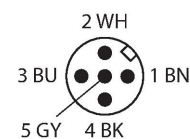
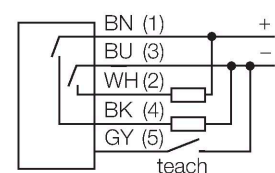

Functional principle

The emitter and receiver are incorporated in the same housing. The light reflection of the target is detected and causes the sensor to switch. Thus the switching distance largely depends on the reflectivity of the target.

Excess gain curve

Excess gain in relation to the distance

Technical data

Housing material	Plastic, Thermoplastic material, Yellow
Lens	plastic, Acrylic
Electrical connection	Cable with connector, M12 × 1, 0.15 m, PVC
Number of cores	5
Ambient temperature	-10...+50 °C
Protection class	IP67
Special features	keep/defer
Power-on indication	LED, Green
Switching state	LED, Yellow
Error indication	LED, green, Flashing
Excess gain indication	LED, red, flashing
Tests/approvals	
MTTF	28 years acc. to SN 29500 (Ed. 99) 40 °C
Approvals	CE

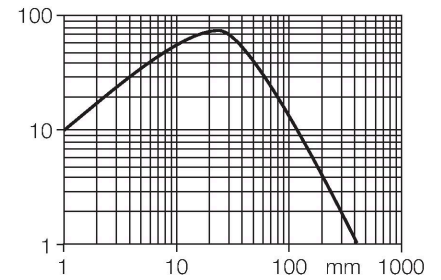

Accessories

SMB30A

3032723

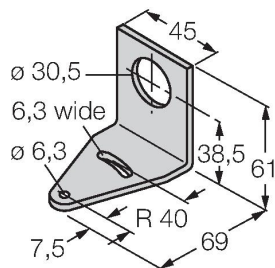

Mounting bracket, rectangular, stainless steel, for sensors with 30mm thread

SMBQS30L

3002809

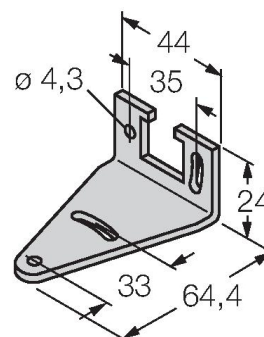

Mounting bracket, stainless steel, for QS30 series

SMB30MM

3027162

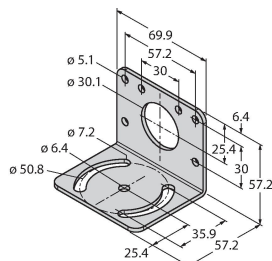

Mounting bracket, rectangular, stainless steel, for sensors with 30 mm thread, wide holes for accurate alignment

SMB30SC

3052521

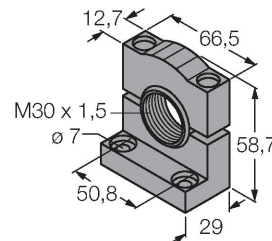

Mounting bracket, PBT black, for sensors with 30 mm thread, rotatable

Accessories

Dimension drawing	Type	ID	
	WKC4.5T-2/TEL	6625028	Connection cable, female M12, angled, 5-pin, cable length: 2 m, sheath material: PVC, black; cULus approval; other cable lengths and qualities available, see www.turck.com
	RKC4.5T-2/TEL	6625016	Connection cable, female M12, straight, 5-pin, cable length: 2 m, sheath material: PVC, black; cULus approval; other cable lengths and qualities available, see www.turck.com