



Screw Fastening Counter

Instruction Manual

DLR5040A - WN

Manufactured by Nitto Kohki Co., Ltd.

Contents

1. Safety Precautions	2
2. Overview	4
3. Product Organization	4
4. Principles of Operation	4
5. Specifications	5
6. Parts Denomination	6
7. Installation	7
8. Making Connections	7
9. Setup	9
10. Operating Instructions	15
11. Usage Tips	17
12. For users of screw fastening counters of old versions	18
13. Troubleshooting	19

* For instructions on how to handle the electric screwdriver, refer to the instruction manual included with the electric screwdriver.

Definitions of Symbols and Signal Terms

Count Collect:	A function of exactly counting the number of successfully-fastened screws using the collection timer
Collection timer:	A timer to set an expected time period required to fasten a screw
Count Return:	A function of decrementing the screw count by one when retightening a fastened screw
Link Connection:	A function of connecting two or more screw-fastening counters to fasten screws in sequence

Definitions of Symbols and Signal Terms

Definitions of the symbols and signal terms appearing at the beginning of a cautionary statement are given below.

Note that even a topic described in  Caution could result in a serious consequence depending on the situation. Be sure to abide by the important instruction given.



Warning

Advises you that incorrect use of the product could result in death or serious personal injury.



Caution

Advises you that incorrect use of the product could result in personal injury or property damage.

Note: Points out important information on installing, operating or maintaining your product.

1. Safety Precautions

- Be sure to abide by the Safety Precautions listed below to prevent accidents, such as fires, electrical shocks, and physical injury.
- Before using the product, please read the Safety Precautions thoroughly to ensure that you use the product correct as instructed.
- After reading the Safety Precautions, keep it in a place that is accessible to anybody who uses the product.



Warnings

1. Keep the installation location clean at all times.

- An installation location or workbench littered with objects can be a source of accidents.

2. Secure the counter in a flat location with good visibility.

- The counter, if located otherwise, could fall out of position. Moreover, working in an unnatural posture could lead to unforeseeable accidents or physical injury.

3. Allow for the ambient conditions in the workshop.

- Keep the workshop fully illuminated.
- Do not use the product in flammable liquid or gas atmospheres.

4. Watch for electrical shock hazards.

- Completely ground the power cord. If the power cord is not grounded, you might get electric shocks.
- Do not touch the power plugs with wet hands. You might get electrical shocks.
- While you use the electric screw fastening counter, take care to keep your body from coming into contact with a grounded object (such as a pipeline in factory, heating apparatus, microwave oven or refrigerator).

5. Keep children out of reach of the product.

- Never allow people other than workers to touch the electric screw fastening counter or cord.
- Never allow people other than workers to gain access to the workshop.

6. Store the product in order when it is out of service.

- Store the product in a dry place out of reach of children or that is locked.

- 7. Do not use the product past its rated capacity.**
 - Work at the speed that is compatible with the capacity of the electric screw fastening counter for optimal work safety and efficiency.
- 8. Use the electric screw fastening counter matched to the kind of work you want to carry out.**
 - Do not use the electric screw fastening counter for purposes other than its intended applications.
 - Make sure the rated voltage is supplied to the screw fastening counter.
- 9. Do not handle the cord (cable) roughly.**
 - Do not carry the electric screw fastening counter by holding its cord (cable) or unplug it from the AC outlet by pulling the cord.
 - Do not keep the cord (cable) close to heat, oils or sharp edges.
- 10. Use discretion in taking care of the screw fastening counter.**
 - Check up the cord from time to time and, when it is found damaged, ask your dealer for repair services.
 - When using an extension cord, check it up from time to time and, when it is found damaged, replace it.
- 11. Turn off the unit switch and unplug the electric screw fastening counter from the AC let in any of these conditions:**
 - When the product is placed out of service
 - When the product is rewired or otherwise reconfigured
 - When any hazards are anticipated
- 12. Check for damaged parts.**
 - Before using the electric screw fastening counter, check for any damages to its parts fully to make sure that the product works correctly and demonstrates its intended functionality.
 - Check all parts of the electric screw fastening counter that may affect its performance.
- 13. Use accessories of the specified types.**
 - Never use accessories other than those recommended in this instruction manual.
- 14. Have the product repaired by an authorized technician.**
 - Do not make modifications to the product, which will void our warranty.
 - Be sure to have your product repaired by your dealer. A product repaired by personnel wanting in the concept or skills of repairs would not only fail to demonstrate its functionality to full satisfaction but could result in physical injury or accidents.
- 15. Do not overhaul or give strong impacts or vibrations to the product.**
 - Do not overhaul the product because it is a precision instrument. If the counter should fail under excessive impacts or vibrations, it would not only fail to demonstrate its functionality to full satisfaction but could result in physical injury or accidents.

2. Overview

The Screw Fastening Counter DLR5040A enables reliable screw fastening management by its built-in screwdriver control function. With a built-in microcomputer, the DLR5040A enables setting of a wide range of screw fastening conditions, prevention of human errors, and high-reliability screw fastening management.

To be available to various assembling jobs, the DLR5040A enables counting of two kinds of parts (up to 9 counts each) in addition to the screw fastening counting. These kinds of counting can be used together. [External count function]

Further, you can build up a simple sequential screw fastening system by connecting the DLR5040A screw fastening counters in series without using any external controller such as a programmable controller. [Link connection function]

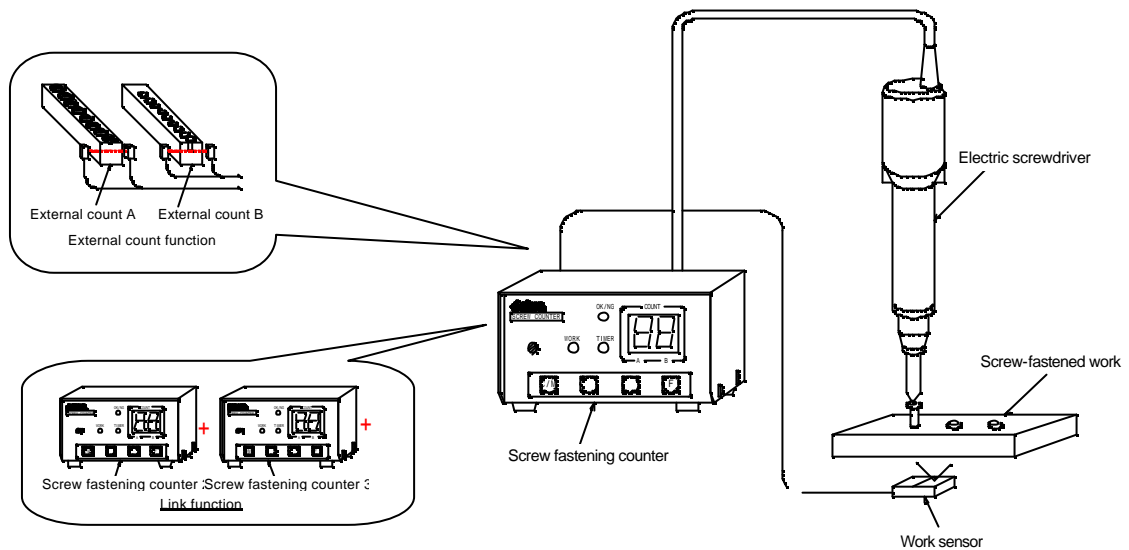

Basic configuration

3. Product Organization

This screw fastening counter works in a pair with any electric screwdriver (DLV7000/7100/7200/8000/8100/8200-SPC Series).

- * Use of the screw fastening counter in conjunction with a work present signal, such as one transmitted from a work sensor, is recommended. Work sensor signal input to the counter enables it to work to your full satisfaction.

Electric screwdriver + **Screw fastening counter** + **Work sensor (third-party's product)**

4. Principles of Operation

The Screw Fastening Counter DLR5040A detects the start signal that is generated by an electric screwdriver and the torque reached signal that is generated at the completion of screw fastening to count fastening times and thus to prevent omissions along with the work sensor signal.

If, because of a fastening error (elevated screw or double fastening), a torque reached signal comes before the fastening time set on the timer built in the counter elapses, no count is recognized (count correction function).

In the event of refastening, a reverse signal that is output from the electric screwdriver reverses the count by one (count return function).

5. Specifications

Item	Specification	Remarks
Count	1 to 99	Set with the front-panel switch (including an external count).
External count input	2 inputs (PARTS_A/PARTS_B)	Set with the front-panel switch (count: 0 to 9 for each input)
Counting method	Count-up/Count-down	Set with the rear-panel DIP switch (DIP-SW1).
Count correction function	Counted only on normal fastening	Not counted if the signal comes before the correct timer times out.
Correct timer setting	0.01 to 0.99 second (With auto collection timer)	In steps of 0.01 second (set with the front-panel switch) The Auto Collection timer automatically selects the minimum value.
Work detection function	Yes (1 input)/No	Set with the rear-panel DIP switch (DIP-SW5).
Work set timer setting	0 to 3.0 seconds	In steps of 0.5 second (set with the front-panel switch)
OK output timer setting	0 to 3.0 seconds	In steps of 0.5 second (set with the front-panel switch)
NG buzzer setting	ON(1)/ON(2)/OFF	Set with the front-panel switch.
OK buzzer setting	ON(1)/ON(2)/ON(3)/OFF	Set with the front-panel switch.
Count return function	ON/OFF	Set with the rear-panel DIP switch (DIP-SW2).
NG evaluation start timing setting	WORK SET/DRIVER ON	Set with the rear-panel DIP switch (DIP-SW3).
Automatic/manual OK evaluation setting	AUTO/MANUAL	Set with the rear-panel DIP switch (DIP-SW4).
Screwdriver lock function	ON/OFF	Set with the rear-panel DIP switch (DIP-SW6).
Link connection	Yes (up to 10 units)	Controlled on a rear-panel terminal block connection.
Terminal block external input	Sensor/RESET/LINK-IN/ PARTS_A/PARTS_B	Photocoupler input (24 VDC 5 mA consumption)
Terminal block external output	OK/NG/LINK-OUT	Open collector output (maximum capacitance 24 VDC 30 mA)
Parameter memory	Parameters stored in internal nonvolatile memory	The memory is initialized by the CM key after the counter is powered on
Power supply	100 VAC to 240 VAC 50/60 Hz	Screwdriver unit matched to the available voltage used
Fuse rating	250 VAC/3A x 2 fuses	φ5 × 20 glass-enclosed fuse
Dimensions	100(W) × 60(H) × 120(D) mm	
Mass	0.6kg	
Screwdrivers	DLV7000/7100/7200 8000/8100/8200-SPC	Dedicated screwdriver with REVERSE signal output
Accessory	Power cord (1.5 meter long)	With UL3P earth

* **Differences between DLR5040-WN and DLR5040A-WN**

DLR5040A-WN differs from DLR5040-WN in the following:

- Improves the count response (Minimum response of the collection timer: 0.05 second 0.01 second)
- Adds OK and NG beep sounds (2 NG sounds and 3 OK sounds, selectable)
- Can set the collection timer at intervals of 0.01 second. (DLR5040-WN sets the collection timer at intervals of 0.05 second.)
- Adds a collection timer function. (DLR5040-WN sets the collection timer only manually.)
With the above functions, some functions of your electric screwdriver may be not available in combination. For more information, see Section 12. (Page 18).
- Substituted the power cord by a power cord with a 3-prong grounded plug.

6. Parts Denomination

Front

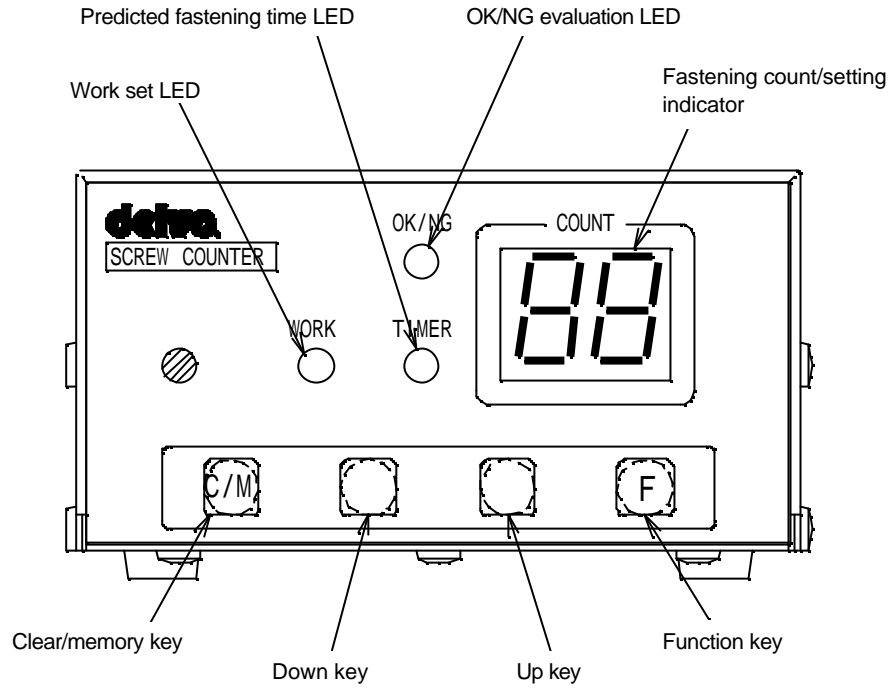

Rear

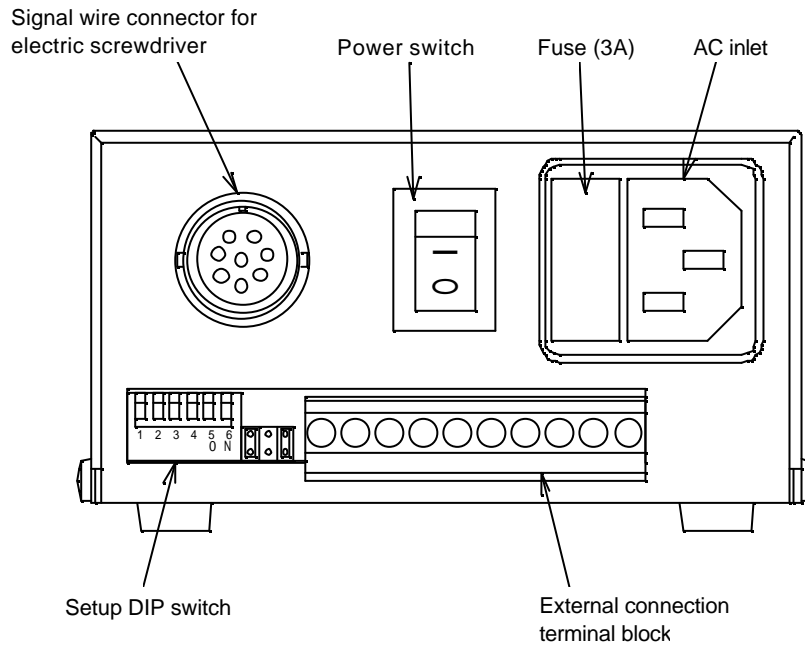

7. Installation

7-1 Installation Location

Install the screw fastening counter in a flat location with good visibility. Lay connections, such as the power cord and the screwdriver cord, along a wall surface or poles and clamp them in firm position.

7-2 Ambient Environment

Install the screw fastening counter in a well-ventilated place indoors that is free from oils, dust, sparks and so forth in the neighborhood.

Particularly, if there is any device installed nearby that generates noises, it could interfere with the counting or OK/NG output performance of the counter. Implement full protection against noises interferences, as by electrical insulation and noise shielding.

8. Making Connections

8-1 Connection of the power cord

Push the connector plug of the power cord firmly into the inlet on the rear of the screw fastening counter.

For safety, be sure to ground the power outlet.

*Do not turn on power now.

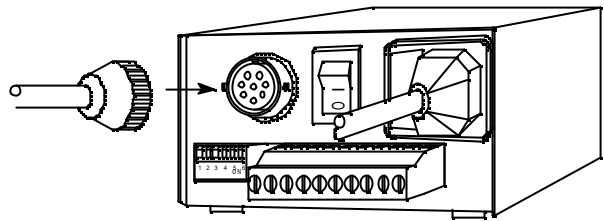

8-2 Connecting an Electric Screwdriver

Use an electric screwdriver dedicated to the screw fastening counter (SPC type).

* The SG type electric screwdriver is not available.

With the counter powered off, insert the metallic connector of an electric screwdriver into the electric screwdriver connection receptacle.

8-3 Connecting External Signal Lines

Connect a work sensor, an OK/NG output signal, an external reset input signal and so forth to the counter rear-panel terminal block. * The terminal block is detachable with connecting the wires.

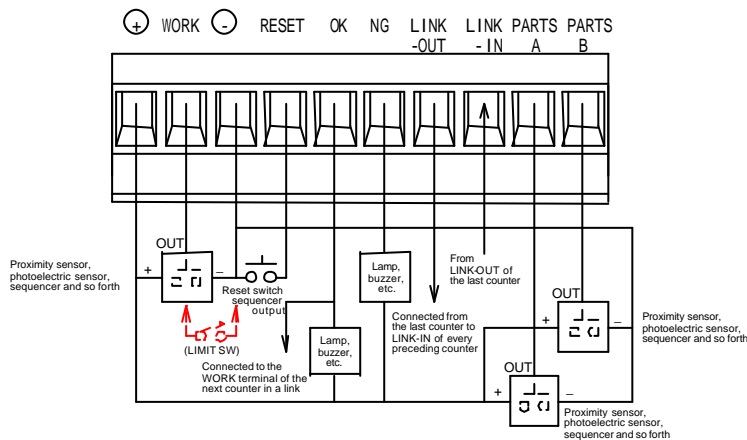

Connection (Example)

- * Sensors connectable as work signals
Three-wire NPN output type sensors recommended, such as photoelectric and proximity sensors
- * Recommended lead wire diameters of signal lines connected to the terminal block
AWG 20 or larger recommended

<Terminal block I/O circuit arrangement>

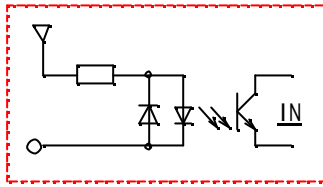

Input circuit (WORK,RESET,LINK IN
PARTS_A,PARTS_B)

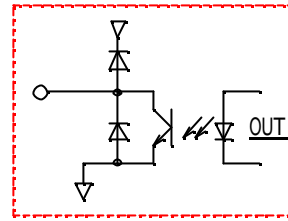

Output circuit (OK, NG, LINK OUT)

* If an external power supply is used

If an external power supply is connected to the I/O terminal of the counter rear-panel terminal block, it is necessary to disconnect the internal power supply of the counter from the terminal block.

Remove two jumper connectors JP1 and JP3 adjacent to the terminal block and connect an external power supply to the ⊕ and ⊖ terminals of the terminal block (power supply: 12 to 24 VDC).

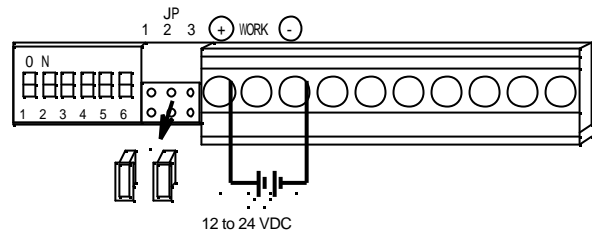

<Terminal block specifications>

No.	Name	I/O	Definition	Signal timing	Remarks
1	⊕		+24 V power supply		Built-in power supply capacity 200 mA max.
2	WORK	Input	Work sensor input	OFF ——— ON	Inputs the ON signal while a work is set.
3	⊖		Common		
4	RESET	Input	External reset input	OFF ——— ON	DIP-SW4 Set to auto: Inputs the ON signal 1 second or longer. Set to manual:Inputs the ON signal 3 seconds or longer.
5	OK	Output	OK evaluation external output	OFF ——— ON	ON until the work is released.
6	NG	Output	NG evaluation external output	OFF ——— ON	ON until the work is set or the RESET switch is pressed.
7	LINK-OUT	Output	Link connection output	ON ——— OFF	Connected from the last counter to LINK-IN of every preceding counter
8	LINK-IN	Input	Link connection input	ON ——— OFF	From LINK-OUT of the last counter
9	PARTS_A	Input	External count input A	OFF ——— ON	Inputs the ON signal when a part is removed.
10	PARTS_B	Input	External count input B	OFF ——— ON	

<I/O specifications>

Input: Photocoupler input (24 VDC max., 5 mA/1 input)

Output: Open collector (No-voltage contact rating: 24 VDC max., 30 mA/1 output)

NOTE

- 1) Before making connections to the terminal block, turn off the power switch to remove concerns over counter failures or electrical shock hazards.
- 2) Sensors may malfunction under the influence of noise interferences depending on where they are installed. Implement full protection against noises interferences, as by grounding. For more details, refer to the sensor maker's instruction manual.









9. Setup

When all the connections are established, set up screw fastening counter with its rear-panel switch being turned on.

Setup items are:

1. Count, timers, and buzzer ON/OFF setup (basic settings) Go to 9-1
2. External count function ON/OFF setup (optional setting) Go to 9-2
3. Count manual preset mode setup (optional setting) Go to 9-3







Follow the steps below to invoke the individual setup modes.

	Setup key	Setup mode	How to reset from setup mode
Setting	 + 	Count, timers, and buzzer setup mode	Press the  key to reset.
	 + 	External count function ON/OFF setup mode	Press the  key to reset.
	 + 	Count manual preset setup mode	Automatic reset

*Settings are stored on reset.

9-1 Count, timers, and buzzer ON/OFF setup (basic settings)

Enter settings to meet work-specific fastening conditions.

- 1) Press the  +  keys to invoke the setup mode.
- 2) Press the  key in sequence to change the setup items (Refer to Table below).
- 3) Press the  or  key to change the setting.
- 4) Press the  key to save the settings and quit.
- 5) To check the set values, press the  key while the counter is standby. The set values are displayed in sequence at an interval of 0.5 second. (When the External Count Input function (see 9-3) is enabled, the External Preset mode is given priority.)

Setup order	Setup item	Indicator	Setup range	Description	Step	Default
 key	Count setting		1 to 99	Sets the number of screws to be fastened	1	1
↓	Work set timer setting	WORK LED (Green) ON	0 to 3.0 sec.	Sets a time period between the setting of a work and the lighting of the WORK lamp (a work recognition time).	0.5	0.0
↓	Correct timer setting	TIMER LED (Orange) ON	0.01 to 0.99 sec.	Sets an expected time period required to fasten a screw.	0.01	0.05
↓	OK output timer setting	OK LED (Green) ON	0 to 3.0 sec.	Sets a time period between the end of screw fastening and the output of an OK signal or the start of the Count Return function.	0.5	0.0
↓	NG buzzer ON/OFF setting	NG LED (Red) ON	0: OFF 1: ON1 2: OFF2	NG1: Beeps when a work is released. NG2: Beeps when a work is released or when a fastening trouble occurs.		1
↓	OK buzzer ON/OFF setting	OK LED (Green) ON	0: OFF 1: ON1 2: ON2 3: ON3	ON1: Outputs a chime sound when the screw fastening job is complete. ON2: Bleeps when a screw is fastened up or outputs two chimes when the screw fastening job is complete. ON3: Outputs a sol-fa sound ("Door, Ray, Me") when the screw fastening job is complete.		1

* If the preset collection timer value is too short, the count may be incremented even by an excessive fastening.

<Collection Timer Auto setting >

In the Collection Timer Auto setting, the Collection Timer function automatically measures a time required to fasten each screw and reflects it on the timer setting value. By repeating screw fastening several times, the minimum fastening time is updated in sequence and the optimum one of the minimum values is selected and displayed.

If the displayed time value is wrong (e.g. quick torque-up by screw gnawing) in the Collection Timer Auto setting, you can cancel the minimum value by pressing the or key. To set an expected screw fastening time, start the Collection Timer Auto setting again from the beginning.

9-2 External count input function ON/OFF setup (optional setting)

You can get both the count of fastened screws and the external count by feeding the External Count Input signal to the PARTS_A or PARTS_B terminal on the rear terminal board.

This function is effective in various small-scale assembling jobs to prevent careless fastening failures.

- 1) Press the **[F]** + **[]** keys to invoke the setup mode.
- 2) The current setting displays first (between 0.0 and 9.9).
- 3) The digit in each position sets a count of PARTS_A or PARTS_B.
(0: Invalid, 1 to 9: External count value)
- 4) Press the **[]** or **[]** key to change the setting.
The setting changes from 0.0 to 0.1 and from 9.8 to 9.9.
(The **[]** key changes the setting in reverse direction)
- 5) Press the **[C/M]** key to save the setting and quit.
- 6) If an external count input signal is enabled, connect an external count input signal line to the appropriate terminal of the counter rear-panel terminal block.
- 7) Enter a sum total of the screw fastening and external counts as a count in 9-1.

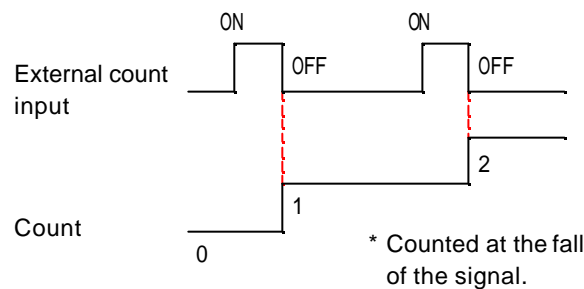
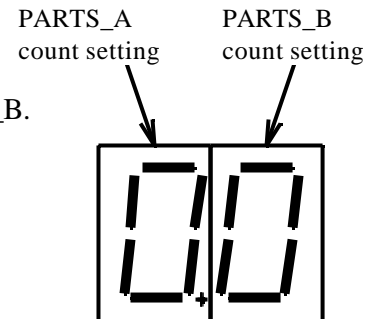

External count input timing

NOTE

- 1) The external count input and the screw fastening count are not prioritized.
- 2) If an external count input comes before work is set when a work present signal is programmed, an NG signal is generated to prevent an unloading error.
In this case, press the **[C/M]** key to reset the NG display.
- 3) The NG signal is output when the counting is complete and a work is released although the External Count Input mode is set. In this case, set the work again and remove the part or press the **[C/M]** key to reset the NG display.
- 4) An NG signal is also generated if an external count input comes after the external count has completed.
In this case, press the **[C/M]** key to reset the NG display.

9-3 Count manual preset mode setup (optional setting)

If a worker needs to change counts frequently during the screw fastening work for a day (high-mix low-volume production), turn on this function to ease the work of changing counts.

- 1) Press the **F** + **C/M** keys to change the setting automatically.
- 2) The setting is enabled if the indication has changed from 00 to 11 and is disabled when the indication has changed from 11 to 00.
- 3) While the counter is in the standby state with the setting enabled, press the or key to change count. To accept the new setting, press the **C/M** key.

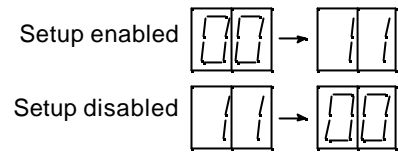

NOTE

- 1) It is recommended that this function be disabled, except when it is needed, to prevent operator mistakes.
- 2) Manual preset mode does not when a work sensor is disabled (SW-5/OFF). Be sure to have work sensor enabled for manual preset mode to take effect.
- 3) Note that, when the Preset mode is enabled, the basic setting check function (when the key is pressed while the counter is standby) is not available because the Preset mode is given priority.

9-4 Setting Counter Rear-Panel DIP Switches

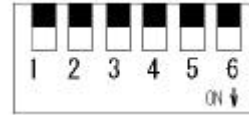

SW	Item	OFF	ON
1	Counting method setting	Count-down mode	Count-up mode
2	Count return function reset	Count return enabled	Count return disabled
3	Count evaluation timing setting	Enabled after work is set	Enabled after the screwdriver rotates
4	Automatic/manual OK setting	OK output (when count = setting)	OK output when work is released
5	Work sensor signal input available/disable setting	Sensor signal input available	No sensor signal input available
6	Screwdriver interlock reset	Interlocked with the setting of work	Interlock reset

<Switch explanation>

SW-1 Counting method setting (when shipped: set to count-down)

The fastening counting method can be changed to count-down (remaining count displayed) or to count-up (fastened count displayed). In most situations, the count-down method would be easiest to manage.

* For users of the screw fastening counters (DLR5031/5030), use of the count-up method is recommended to match the conditions.

SW-2 Count return function reset (when shipped: set to count return enabled)

This screw fastening counter has a built-in function to reverse one count when a screw is loosened after it has been once fastened. If this function is not used, it should be disabled to avoid faulty operations.

* The count would reverse, for example, even if a screwdriver is idled by reversing after it has been fastened.

NOTE

- 1) The count would not reverse if the screwdriver is reversed when it has not been fastened at all. The screwdriver would reverse only one count even if the screwdriver is reversed twice.
- 2) The electric screwdriver of the DLV7000/7100/7200/8000/8100/8200-SG type cannot be connected.

SW-3 NG evaluation start setting (when shipped: set to enable after work is set)

* This setting is enabled only if a work sensor signal line is connected to the counter rear-panel terminal block and the DIP switch (SW-5) is set to work sensor signal input available.)

An NG indication and an NG signal are generated if work is unloaded without the preset count and the fastened count not equaling with the counter set to use a work sensor signal. You can choose when to start the NG evaluation process; that is, start the evaluation process from the moment at which work is mounted on the jig or after the screwdriver is rotated.

If the NG evaluation process is programmed to work after work is set, an NG indication is generated when the work is inadvertently unloaded as a finished product after the fastening work is resumed in case of a pause.

If work has to be temporarily unloaded after it has been set, the NG evaluation might be inconvenient. In this usage mode, the NG evaluation process can be programmed to work after the screwdriver is rotated to suppress the NG evaluation.

SW-4 Automatic/manual evaluation setting (when shipped: set to automatic setting)

With the normal setting (automatic evaluation), an OK indication and an OK output are automatically generated when the preset count and the fastened count equal. The work is unloaded on the basis of the OK indication and fastening of the next work begins. However, equal even though fastening has been carried out at positions other than the specified fastening position, successful fastening would be assumed as long as the two counts equal.

The manual evaluation process lets you visually check the fastening work and then unload then work for OK output. The manual evaluation setting renders an OK evaluation of the work after its fastening has been verified to ensure positive fastening performance.

* If the manual evaluation process is set, an NG evaluation would be generated if work is unloaded without the preset count and the fastened count not equaling. Further, if further fastening is attempted in a 0 count state in count-down mode, 99 would be displayed. If the improperly fastened screw is removed by reversing, an OK evaluation would result with the preset count and the fastened count equaling, but the screw cannot be reversed by the fastened count exceeds the preset count by two or more (only one count return allowed). (This also holds true in count-up mode.)

SW-5 Work sensor signal input available/disable setting (when shipped: set to sensor signal input available)

Though this screw fastening counter evaluates fastening conditions on the basis of the correspondence between the work sensor signal and the fastened count. It can count fastening times in a simplified manner even when work sensor signal input is not available. In this situation, an NG evaluation cannot be produced because only an OK evaluation is displayed and generated when the preset count and the fastened count equal. OK output is produced for the period of time set by the OK output timer in 9-1.

* The combined use of a work sensor signal is recommended to render an NG evaluation.

NOTE

When "Work Detection Disabled" is ON, "Evaluation Auto" is always set independently of the setting of "Evaluation Auto/Manual" (DIP switch SW-4 OFF).

SW-6 Screwdriver ON (interlock)/OFF (reset) (when shipped: set to screwdriver lock interlock)

The screw fastening counter keeps the work powered on only for the duration of its fastening after it is mounted in position (WORK lamp being lit) to prevent fastening errors. Its purpose is to prevent accidents or physical injury caused by screwdrivers in times other than fastening. When using a screwdriver temporarily in operations other than assembly, release the driver lock.

10. Operating Instructions

10-1 Work Sensor Signal Input Available and Normal Fastening

- 1) Connect work sensor output or a work sensor signal to the counter rear-panel terminal block. Connect external I/O signal lines to meet your usage conditions.
- 2) Turn on the power switch but not before verifying the correct connections.
- 3) Set the front-panel setup mode to meet your usage conditions.
- 4) Set the counter rear-panel DIP switches to meet your usage conditions (set DIP-SW5 and 6 to OFF).
- 5) Mount the work to be fastened on the jig.
- 6) When the front-panel WORK lamp (green) lights up after the work is mounted, start fastening. The count on display will count down (up) as the work is fastened successfully.
- 7) The OK lamp (green) lights up when a preset count of fastening has been attained.
- 8) Unload the work from the jig and set new work in its place.

<Fastening NG>

- 1) The NG lamp (red) lights up when the work has been under-fastened or when the work is unloaded without a fastening defect being corrected.
- 2) The OK lamp (green) lights up when the work is remounted on the jig and then refastened to achieve the preset count of fastening after the defect has been verified.
- 3) To remove the work out of line as being defective, press the front-panel **C/M** key or an external reset switch for longer than 1 second (or longer than 3 seconds if DIP-SW4 is ON).

10-2 Work Sensor Signal Input Unavailable and Normal Fastening

- 1) Set the counter rear-panel DIP switch (DIP-SW5) to ON.
- 2) The OK lamp lights up automatically.
- 3) Carry out fastening the same way as described in 10-1.
- 4) The OK lamp (green) lights up when the fastening is completed.

NOTE

- 1) Without work sensor signal input available, no NG evaluation is produced when the work is unloaded. Always watch for the OK signal in fastening work.
- 2) The rear-panel DIP switch DIP-S4 has no effect (fixed to automatic evaluation).

10-3 Using the external count function in screw fastening

- 1) Connect a parts detector or the like to the PARTS_A or PARTS_B terminal on the terminal board.
- 2) See 10-1 for setting to use the work detecting function or 10-2 for setting not to use the function.
- 3) Set external counts with reference to 9-1 and 9-2.
- 4) Make sure the WORK lamp lights and start screw fastening or part removal.
- 5) When the number of fastened screws and the external count reach the preset values, the OK lamp lights.

(If DIP SW-4 is set to the ON position, the OK lamp lights when the work is released.)

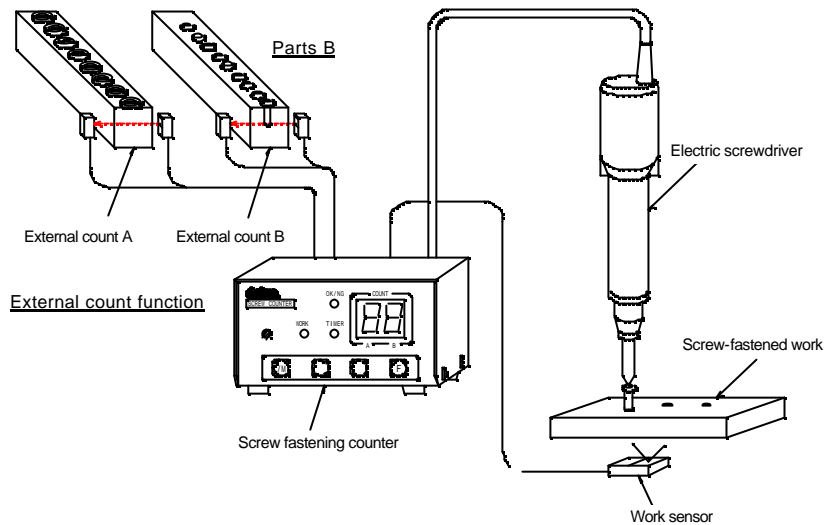

NOTE

- 1) When you remove a part before the WORK lamp lights, the NG lamp lights. In this case, press the **C/M** key and reset the NG status.
- 2) If the OK lamp remains off after the count reaches 0 or the preset count value, the total of the external count and the number of the fastened screws may be the preset value. Check the count setting.
- 3) If the NG lamp lights when you remove a part, the number of parts may be greater than the external count. Check the external count setting.
If the more parts are removed by mistake, press the **C/M** key and reset the NG status.

10-4 Link Connection

Use the **LINK-IN** and **LINK-OUT** terminals of the counter rear-panel terminal block to hook up multiple counters on a single link. Using this function, only worker can fasten multiple screwdrivers in the order in which counters are connected.

* Up to 10 counters can be connected.

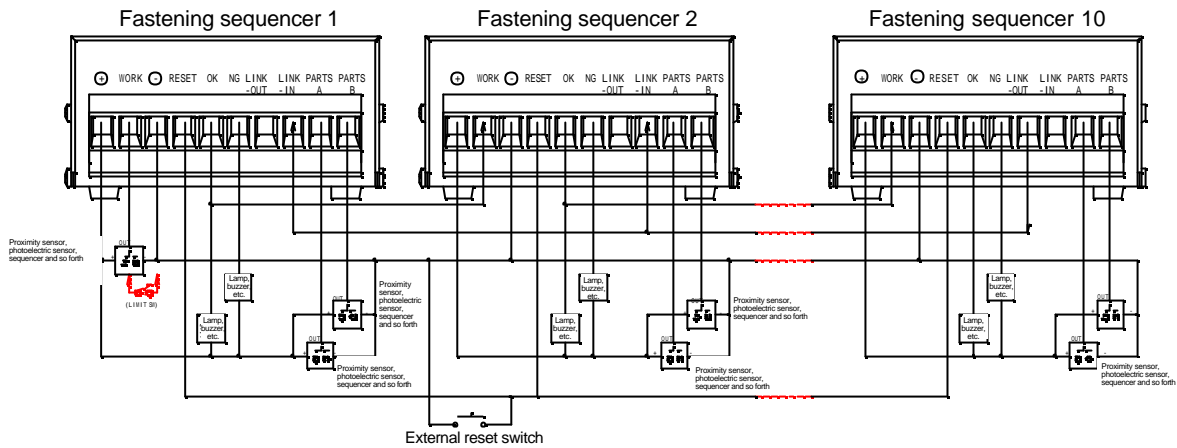

Typical link connection

NOTE

- 1) External OK and NG output can be individually produced for each screw fastening counter on the link or in a batch for all. Choose the method of connection to meet your usage conditions.
- 2) Use a single reset input for shared use among all the screw fastening counters on the link.
- 3) If the counter rear-panel DIP switch SW-6 “screwdriver lock” is set to enable (OFF), only the electric screwdrivers interlocked with the fastening sequence are enabled. Use of SW-6 being set on is recommended to avoid the use of electric screwdrivers from the wrong sequence.

11. Usage Tips

- 1) Complete terminal block connections before powering on the counter, because making such connections with the counter switched on would be most hazardous.
- 2) If you press the **C/M** key while mounting work, the count and the counter status would be reset to their defaults.
- 3) Making changes to the setting conditions while fastening work could cause the counter to malfunctions. If such changes are necessary, make them while the counter is in the standby state or before powering it on.
- 4) If you discontinue the lever operation immediately before the electric screwdriver torque rises, the counter would be unable to recognize the signal when the torque rise due to an inertia force, so that the count would remain unchanged. Continue the operation until the electric screwdriver stops completely.
- 5) Avoid idling or additional fastening immediately after the start of counting to avoid incorrect counting.
- 6) If you turn on the power switch while the **C/M** key is pressed, all the settings are reset to their defaults.

12. For users of screw fastening counters of old versions

When the user uses a screwdriver for the DLR5040-WN screw fastening counter, some of the functions of DLR5040-WN may be not available when used together with DLR5040A-WN.

When you use one of the following electric screwdrivers with a fastening time of shorter than 0.05 second (which is shorter than the setting of the collection timer), the collection timer cannot count exactly.

How to distinguish electric screwdrivers

When using DLR5040A-WN together with electric screwdrivers of serial numbers of "053xxxx" and earlier, change the setting as follows to prevent malfunctions:

Setting

- 1) Turn on the power switch while pressing down the key.
- 2) Make sure check lamps light and "9 " (where " " is a blank) is displayed. With this, the DLR5040A-WN setting becomes compatible with the DLR5040-WN setting.
- 3) From this time on, the settings are all stored in memory and will not be deleted when the screwdriver is powered off.
- 4) To reset the setting to the latest one, turn on the power switch while pressing down the key.

NOTE

- 1) When the power switch is turned on with the key pressed down, the setting is reset to the default setting (made at the factory).
In this case, all your settings in memory are also reset to initial values and you must set the values again.
- 2) DLR5040-WN is not limited by the production time of electric screwdrivers.

13. Troubleshooting

	Symptom	Possible causes and checks	Repairing
1	The WORK lamp does not light.	<ul style="list-style-type: none"> - Is the sensor connected to the terminal board? - Is the sensor powered on? - Does the sensor detect a work? - Is the Work Set timer value too great? 	<ul style="list-style-type: none"> - Check and correct the connection. - Supply power to the sensor. - Adjust so that the sensor may detect the work. - Set an adequate Work Set timer value.
2	No counting	<ul style="list-style-type: none"> - The WORK lamp remains OFF. - The collection timer has not been expired. - The screwdriver is removed before the torque is complete. - The screwdriver is frequently applied and detached to fasten the screw. - The screwdriver for the screw fastening counter is of the old version. 	<ul style="list-style-type: none"> - Cause the sensor to detect the work. - Set an adequate collection timer value. - Be sure to apply the screwdriver to the screw until the torque is complete. - Be sure to complete each screw fastening without a break. - Change the setting. See Section 12 (Page 18).
3	Counting is complete but "OK" is not displayed.	<ul style="list-style-type: none"> - Check whether DIP SW-4 is ON (Evaluation Manual). 	<ul style="list-style-type: none"> - Set DIP SW-4 to the OFF (Evaluation Auto) position.
4	"NG" is displayed when a work is released.	<ul style="list-style-type: none"> - The count value is not equal to the number of actually fastened screws. - An external count has been set. 	<ul style="list-style-type: none"> - Fasten the preset number of screws. - Set the external count to OFF (0.0).
5	Inactive screwdriver	<ul style="list-style-type: none"> - The sensor does not detect the work. - The FORWARD/BACKWARD switch of the screwdriver is OFF. - The count is 0. 	<ul style="list-style-type: none"> - Place the sensor on an adequate detecting position. - Turn on the FORWARD/BACKWARD switch. - Release the work or press the [C/M] key.
6	The preset values cannot be displayed (although the [] key is pressed while the screw fastening counter is standby).	<ul style="list-style-type: none"> - The Count Manual Preset mode has been set. 	<ul style="list-style-type: none"> Press the [F] and [C/M] keys to reset the Manual Preset mode.
7	Unknown setting		<ul style="list-style-type: none"> Turn on the power switch while pressing down the [C/M] key to clear all setting in memory.

* For more information (questions, application guides, etc.), call your local NITTO KOHKI distributor or support center.

Cutting along this line

■ Warranty

While this product has been manufactured under the perfection of an exacting standard of quality control, we warrant your product to be free from malfunctions and defects in both materials and workmanship for one year from the date of purchase.

Your product is serviceable for a fee, however, if its failure has been caused by:

1. Improper use failing to comply with the directions for use in the instruction manual
2. Unauthorized repairs or modifications
3. Impacts and shocks
4. Improper storage or inadequate care
5. Acts of God and unusual voltages

Notes

- 1 Please produce this card, along with the product, to your dealer to request repair services.
- 2 The warranty is valid only within Japan.

Control No.: _____

Date of Purchase: _____



Headquarters/Research center: Naka-Ikegami 2-9-4, Ota-ku, Tokyo 146-8555
Phone +813-3755-1111